

Features

- Compatible with automatic insertion equipment
- Superior package integrity
- Marking on contrasting background for permanent identification

For information on specific applications, download Bourns' application notes:

- DRAM Applications
- Dual Terminator Resistor Networks
- R/2R Ladder Networks
- SCSI Applications

4100R Series - Thick Film Molded DIPs

Product Characteristics

Resistance Range 10 ohms to 10 megohms
 Maximum Operating Voltage 100V
 Temperature Coefficient of Resistance
 50Ω to 2.2 MΩ ±100ppm/°C
 below 50Ω ±250ppm/°C
 above 2.2 MΩ ±250ppm/°C
 TCR Tracking50ppm/°C
 maximum; equal values
 Resistor Tolerance See circuits
 Operating Temperature
 -55°C to +125°C
 Insulation Resistance
 10,000 megohms minimum
 Dielectric Withstanding Voltage
 200 VRMS
 Lead Solderability
 Meet requirements of MIL-STD-202
 Method 208

Environmental Characteristics

TESTS PER MIL-STD-202 ΔR MAX.
 Short Time Overload ±0.25%
 Load Life ±1.00%
 Moisture Resistance ±0.50%
 Resistance to Soldering Heat
 ±0.25%
 Terminal Strength ±0.25%
 Thermal Shock ±0.25%

Physical Characteristics

Flammability Conforms to UL94V-0
 Lead Frame Material
 Copper, solder coated
 Body Material Novolac epoxy

How To Order

41 14 R - 1 - 152

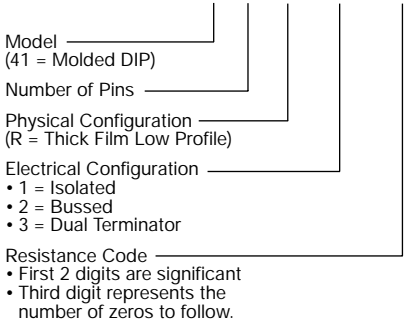

Consult factory for other available options.

Package Power Temp. Derating Curve

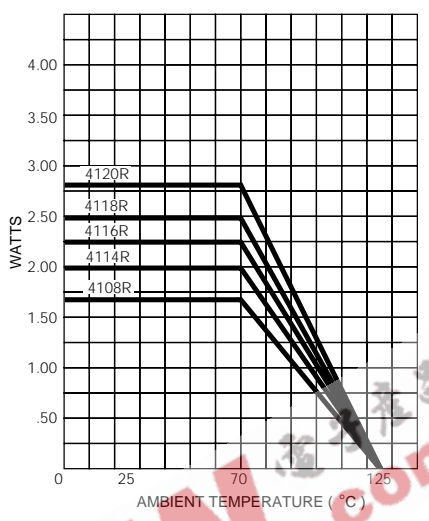

Package Power Rating at 70°C

4108R	1.69 watts
4114R	2.00 watts
4116R	2.25 watts
4118R	2.50 watts
4120R	2.80 watts

Typical Part Marking

Represents total content. Layout may vary.

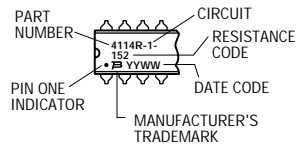

Product Dimensions

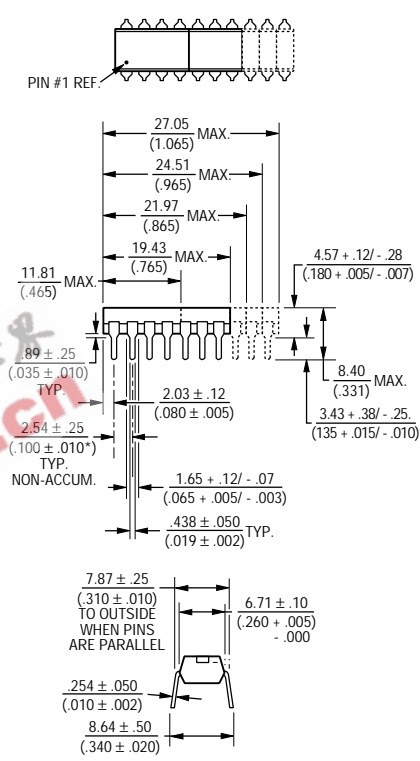

Governing dimensions are in metric. Dimensions in parentheses are inches and are approximate.

*Terminal centerline to centerline measurements made at point of emergence of the lead from the body.

4100R Series - Thick Film Molded DIPs

BOURNS®

Isolated Resistors (1 Circuit)

- Model 4108R-1-RC
(4 Isolated Resistors)
- Model 4114R-1-RC
(7 Isolated Resistors)
- Model 4116R-1-RC
(8 Isolated Resistors)
- Model 4118R-1-RC
(9 Isolated Resistors)
- Model 4120R-1-RC
(10 Isolated Resistors)

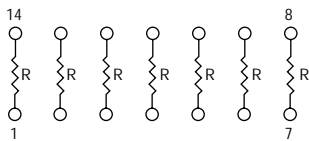

Bussed Resistors (2 Circuit)

- Model 4108R-2-RC
(7 Resistors, Pin 8 Common)
- Model 4114R-2-RC
(13 Resistors, Pin 14 Common)
- Model 4116R-2-RC
(15 Resistors, Pin 16 Common)
- Model 4118R-2-RC
(17 Resistors, Pin 18 Common)
- Model 4120R-2-RC
(19 Resistors, Pin 20 Common)

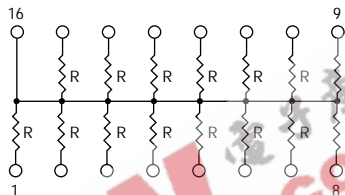

Dual Terminator (3 Circuit)

- Model 4108R-3-R1/R2
- Model 4114R-3-R1/R2
- Model 4116R-3-R1/R2 (shown)
- Model 4118R-3-R1/R2
- Model 4120R-3-R1/R2

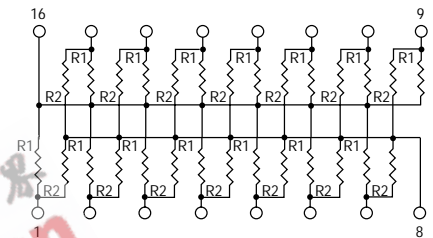

Resistance Tolerance

- 10 ohms to 49 ohms±1 ohm
- 50 ohms to 5 megohms±2%*
- Above 5 megohms±5%

Power Rating per Resistor

At 70°C0.250 watt

Power Temperature Derating Curve

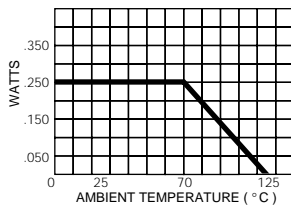

Resistance Tolerance

- 10 ohms to 49 ohms±1 ohm
- 50 ohms to 5 megohms±2%*
- Above 5 megohms±5%

Power Rating per Resistor

At 70°C0.125 watt

Power Temperature Derating Curve

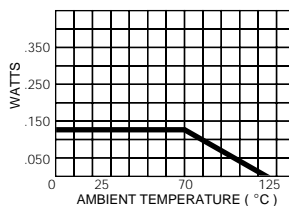

Resistance Tolerance

- Below 100 ohms±2 ohms
- 100 ohms to 5 megohms±2%*
- Above 5 megohms±5%

Power Rating per Resistor

At 70°C0.125 watt

Power Temperature Derating Curve

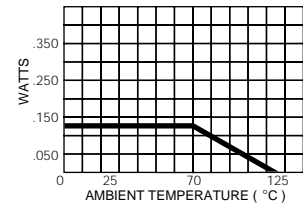

Popular Resistance Values (1, 2 Circuits)**

Ohms	Code	Ohms	Code	Ohms	Code	Ohms	Code	Ohms	Code
10	100	180	181	1,800	182	15,000	153	120,000	124
22	220	220	221	2,000	202	18,000	183	150,000	154
27	270	270	271	2,200	222	20,000	203	180,000	184
33	330	330	331	2,700	272	22,000	223	220,000	224
39	390	390	391	3,300	332	27,000	273	270,000	274
47	470	470	471	3,900	392	33,000	333	330,000	334
56	560	560	561	4,700	472	39,000	393	390,000	394
68	680	680	681	5,600	562	47,000	473	470,000	474
82	820	820	821	6,800	682	56,000	563	560,000	564
100	101	1,000	102	8,200	822	68,000	683	680,000	684
120	121	1,200	122	10,000	103	82,000	823	820,000	824
150	151	1,500	152	12,000	123	100,000	104	1,000,000	105

Popular Resistance Values (3 Circuit)**

Resistance			
(Ohms)		Code	
R ₁	R ₂	R ₁	R ₂
160	240	161	241
180	390	181	391
220	270	221	271
220	330	221	331
330	390	331	391
330	470	331	471
3,000	6,200	302	622

* ±1% TOLERANCE IS AVAILABLE BY ADDING SUFFIX CODE "F" AFTER THE RESISTANCE CODE.

**NON-STANDARD VALUES AVAILABLE, WITHIN RESISTANCE RANGE.

REV. 09/02

Specifications are subject to change without notice.