

International
IOR Rectifier

QUIETIR Series
40EPF.. HV

FAST SOFT RECOVERY RECTIFIER DIODE



$$V_F < 1.25V @ 20A$$

$$t_{rr} = 95 \text{ ns}$$

$$V_{RRM} 1000 \text{ to } 1200V$$

Description/Features

The 40EPF.. fast soft recovery **QUIETIR** rectifier series has been optimized for combined short reverse recovery time and low forward voltage drop.

The glass passivation ensures stable reliable operation in the most severe temperature and power cycling conditions.

Typical applications are both:

- output rectification and freewheeling in inverters, choppers and converters
- and input rectifications where severe restrictions on conducted EMI should be met.

Major Ratings and Characteristics

Characteristics	40EPF..	Units
$I_{F(AV)}$ Sinusoidal waveform	40	A
V_{RRM}	1000 to 1200	V
I_{FSM}	475	A
V_F @ 20A, $T_J=25^\circ\text{C}$	1.25	V
t_{rr} @ 1A, -100A/ μs	95	ns
T_J	-40 to 150	$^\circ\text{C}$

Package Outline

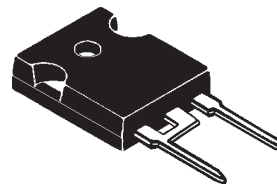

TO-247AC (Modified)

Voltage Ratings

Part Number	V_{RRM} , maximum peak reverse voltage V	V_{RSM} , maximum non repetitive peak reverse voltage V	I_{RRM} 150°C mA
40EPF10	1000	1100	10
40EPF12	1200	1300	

Absolute Maximum Ratings

Parameters	40EPF..	Units	Conditions
$I_{F(AV)}$ Max. Average Forward Current	40	A	@ $T_C = 105^\circ\text{C}$, 180° conduction half sine wave
I_{FSM} Max. Peak One Cycle Non-Repetitive Surge Current	400	A	10ms Sine pulse, rated V_{RRM} applied
	475		10ms Sine pulse, no voltage reapplied
I^2t Max. I^2t for fusing	800	A^2s	10ms Sine pulse, rated V_{RRM} applied
	1131		10ms Sine pulse, no voltage reapplied
$I^2\sqrt{t}$ Max. $I^2\sqrt{t}$ for fusing	11310	$A^2\sqrt{s}$	$t = 0.1$ to 10ms, no voltage reapplied

Electrical Specifications

Parameters	40EPF..	Units	Conditions
V_{FM} Max. Forward Voltage Drop	1.4	V	@ 40A, $T_J = 25^\circ\text{C}$
r_t Forward slope resistance	6.82	$m\Omega$	$T_J = 125^\circ\text{C}$
$V_{F(TO)}$ Threshold voltage	0.94	V	
I_{RM} Max. Reverse Leakage Current	0.1	mA	$T_J = 25^\circ\text{C}$
	10		$T_J = 150^\circ\text{C}$

$V_R = \text{rated } V_{RRM}$

Recovery Characteristics

Parameters	40EPF..	Units	Conditions
t_{rr} Reverse Recovery Time	450	ns	$I_F @ 10\text{Apk}$ @ 25A/ μs @ 25°C
I_{rr} Reverse Recovery Current	6	A	
Q_{rr} Reverse Recovery Charge	1.8	μC	
S Typical Snap Factor	0.5		

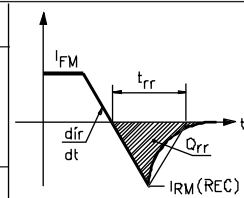

Thermal-Mechanical Specifications

Parameters	40EPF..	Units	Conditions
T _J Max. Junction Temperature Range	-40 to 150	°C	
T _{stg} Max. Storage Temperature Range	-40 to 150	°C	
R _{thJC} Max. Thermal Resistance Junction to Case	0.6	°C/W	DC operation
R _{thJA} Max. Thermal Resistance Junction to Ambient	40	°C/W	
R _{thCS} Typical Thermal Resistance, Case to Heatsink	0.2	°C/W	Mounting surface , smooth and greased
wt Approximate Weight	6 (0.21)	g (oz.)	
T Mounting Torque	Min.	6 (5)	Kg-cm (lbf-in)
	Max.	12 (10)	
Case Style	TO-247AC		JEDEC (Modified)

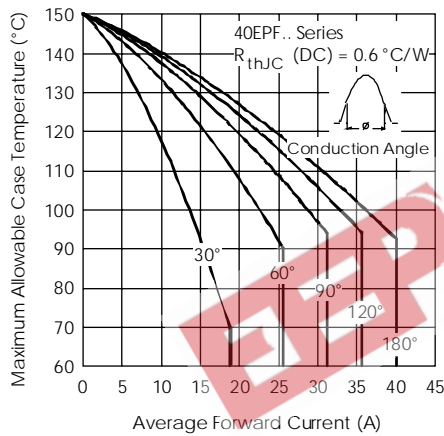

Fig. 1 - Current Rating Characteristics

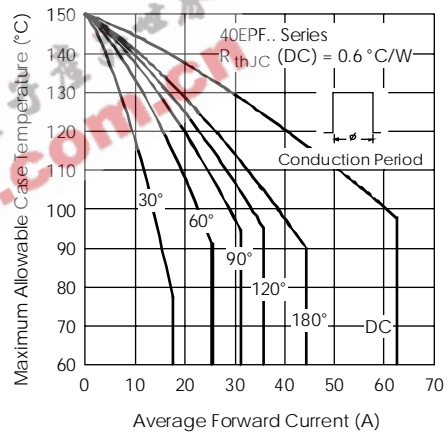

Fig. 2 - Current Rating Characteristics

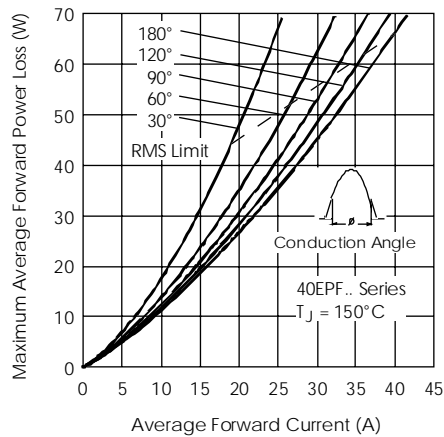

Fig. 3 - Forward Power Loss Characteristics

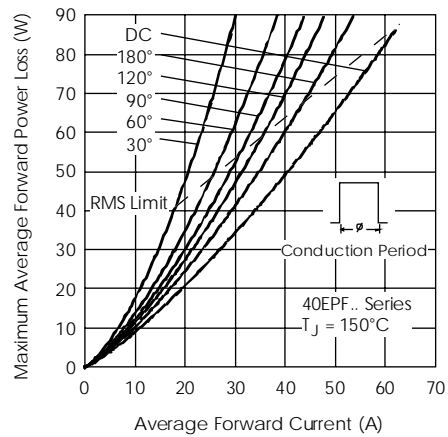

Fig. 4 - Forward Power Loss Characteristics

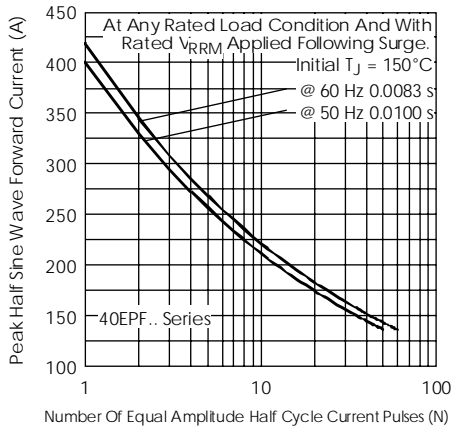

Fig. 5- Maximum Non-Repetitive Surge Current

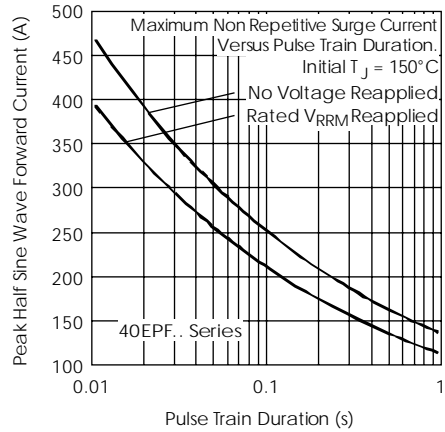

Fig. 6- Maximum Non-Repetitive Surge Current

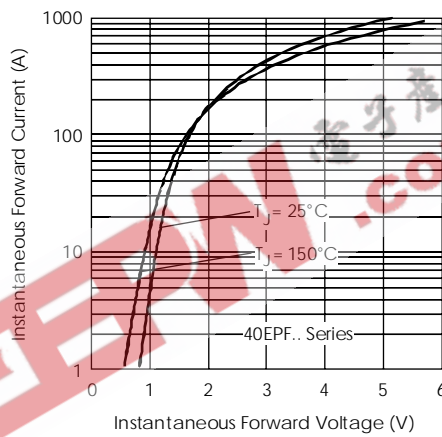

Fig. 7- Forward Voltage Drop Characteristics

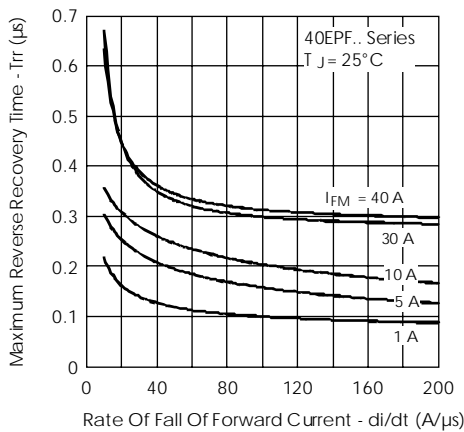

Fig. 8- Recovery Time Characteristics, $T_J = 25^\circ\text{C}$

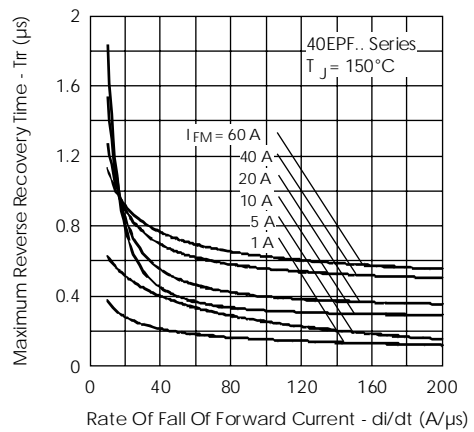

Fig. 9- Recovery Time Characteristics, $T_J = 150^\circ\text{C}$

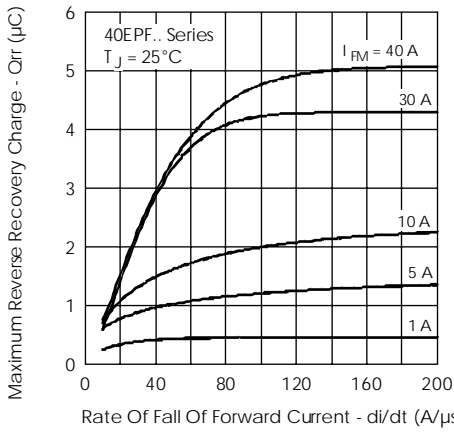

Fig. 10-Recovery Charge Characteristics, $T_J = 25^\circ\text{C}$

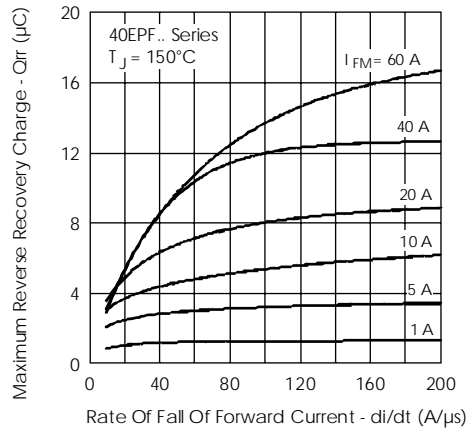

Fig. 11-Recovery Charge Characteristics, $T_J = 150^\circ\text{C}$

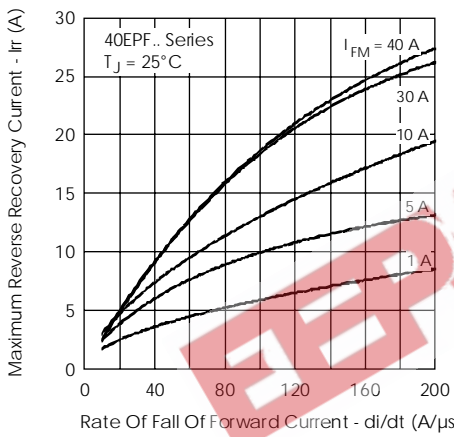

Fig. 12-Recovery Current Characteristics, $T_J = 25^\circ\text{C}$

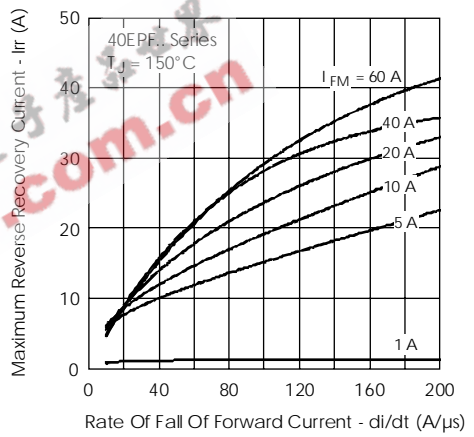

Fig. 13-Recovery Current Characteristics, $T_J = 150^\circ\text{C}$

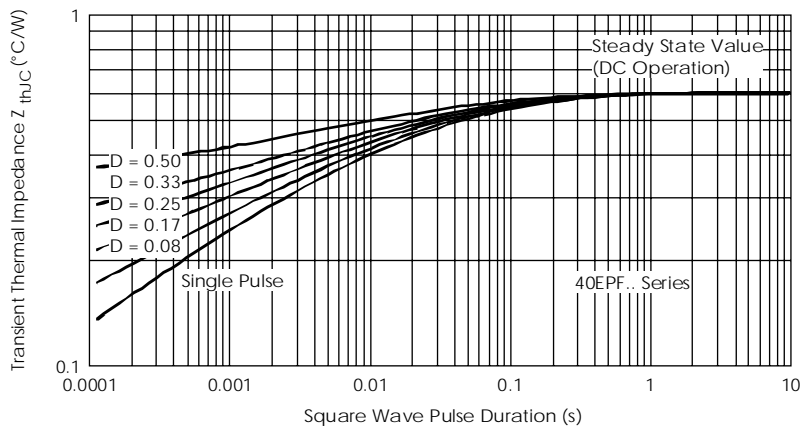
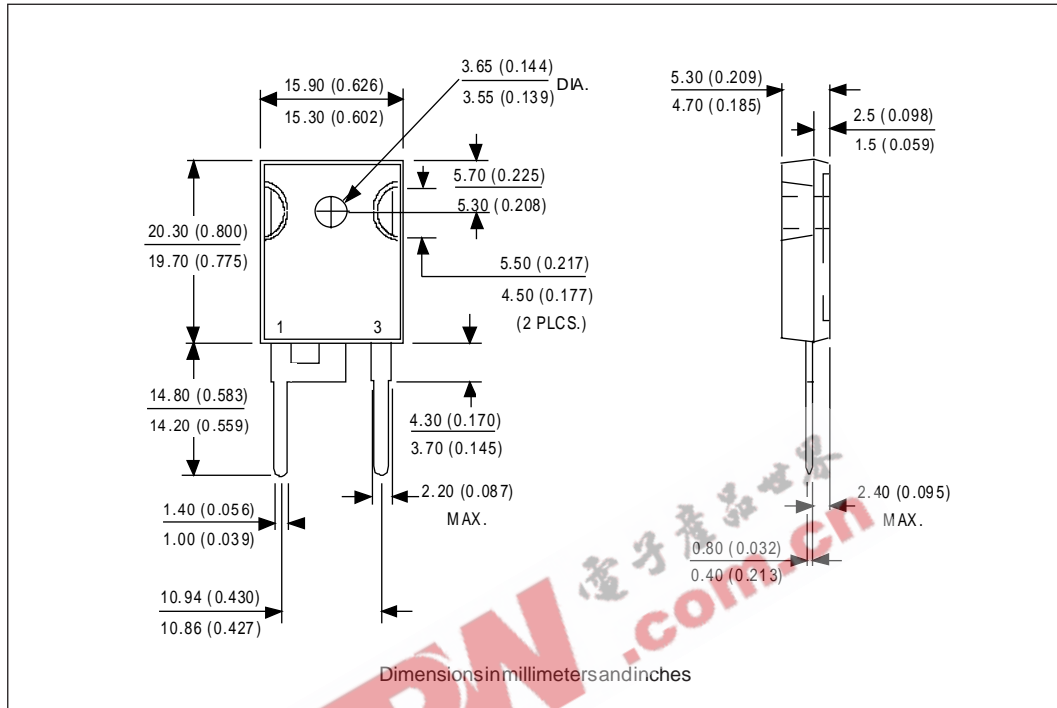

Fig. 14-Thermal Impedance Z_{thJC} Characteristics

Outline Table



Ordering Information Table

