



4066

CMOS IC

QUAD BILATERAL SWITCH

DESCRIPTION

The UTC **4066** is a quad bilateral switch intended for the transmission or multiplexing of analog or digital signals.

FEATURES

- * Wide supply voltage range: 3V ~ 15V.
- * High noise immunity : 0.45V_{DD} (typ.)
- * Wide range of digital and ± 7.5V_{PEAK} analog switching
- * "ON" resistance for 15V operation : 80Ω
- * Matched "ON" resistance : R_{ON}=5Ω (typ.) over 15V signal input
- * "ON" resistance flat over peak-to-peak signal range
- * High "ON" / "OFF" : 65 dB (typ.)
- output voltage ratio @ f_{IS}=10kHz, R_L=10kΩ
- * High degree linearity: 0.1% distortion (typ.) @ f_{IS}=1kHz, V_{IS}=5Vp-p.
- V_{DD}-V_{SS}=10V, R_L=10kΩ
- * Extremely low "OFF" : 0.1nA (typ.)
- switch leakage @ V_{DD}-V_{SS}=10V, T_a=25
- * Extremely high control input impedance : 10¹²Ω (typ.)
- * Low crosstalk : -50dB (typ.)
- between switches @ f_{IS}=0.9MHz, R_L=1kΩ
- * Frequency response, switch "ON" : 40MHz (typ.)

ORDERING INFORMATION

Ordering Number		Package	Packing
Normal	Lead Free Plating		
4066-D14-T	4066L-D14-T	DIP-14	Tube
4066-S14-R	4066L-S14-R	SOP-14	Tape Reel
4066-S14-T	4066L-S14-T	SOP-14	Tube
4066-P14-R	4066L-P14-R	TSSOP-14	Tape Reel
4066-P14-T	4066L-P14-T	TSSOP-14	Tube

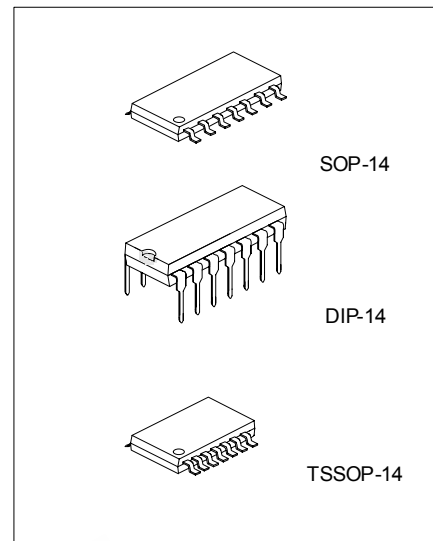

*Pb-free plating product number: 4066L

<p>4066L-D14-T</p> <p>(1)Packing Type (2)Package Type (3)Lead Plating</p>	<p>(1) R: Tape Reel, T: Tube (2) D14: DIP-14, S14: SOP-14, P14: TSSOP-14 (3) L: Lead Free Plating Blank: Pb/Sn</p>
---	--

■ PIN CONFIGURATION

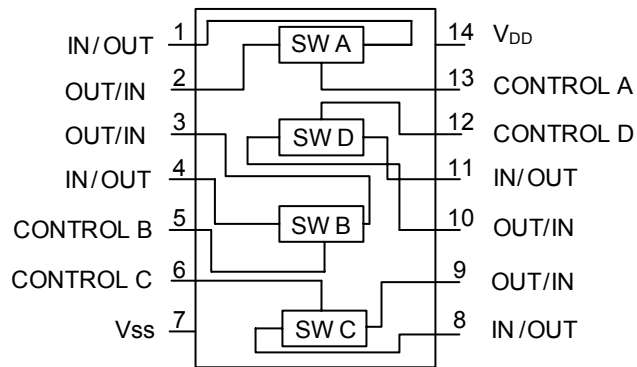

■ SCHEMATIC DIAGRAM

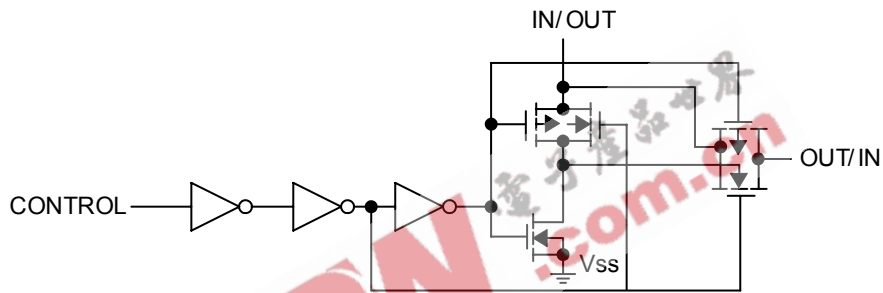

■ ABSOLUTE MAXIMUM RATINGS ($V_{SS}=0V$, unless otherwise specified)

PARAMETER	SYMBOL	RATINGS	UNIT
Supply Voltage	V_{DD}	-0.5 ~ +18	V
Input Voltage	V_{IN}	-0.5 ~ $V_{CC}+0.5$	V
Power Dissipation	DIP-14	700	mW
	SOP-14	500	mW
	TSSOP-14	500	mW
Junction Temperature	T_J	+125	°C
Storage Temperature	T_{STG}	-40 ~ +150	°C

Note Absolute maximum ratings are those values beyond which the device could be permanently damaged. Absolute maximum ratings are stress ratings only and functional device operation is not implied.

■ RECOMMENDED OPERATING CONDITIONS ($V_{SS}=0V$, unless otherwise specified)

PARAMETER	SYMBOL	RATINGS	UNIT
Supply Voltage	V_{DD}	3 ~ 15	V
Input Voltage	V_{IN}	0 ~ V_{DD}	V
Operating Temperature Range	T_{OPR}	-40 ~ +85	°C

■ DC ELECTRICAL CHARACTERISTICS ($V_{SS}=0V$, unless otherwise specified)

PARAMETER	SYMBOL	CONDITIONS	-40°C		+25°C			+85°C		UNITS
			MIN	MAX	MIN	TYP	MAX	MIN	MAX	
Quiescent Device Current	I_{DD}	$V_{DD}=5V$		1.0	0.01	1.0		7.5	μA	
		$V_{DD}=10V$		2.0	0.01	2.0		15	μA	
		$V_{DD}=15V$		4.0	0.01	4.0		30	μA	
SIGNAL INPUTS AND OUTPUTS										
Input or Output Leakage Switch "OFF"	I_{IS}	$V_C=0$		± 50	± 0.1	± 50		± 200	nA	
"ON" Resistance	R_{ON}	$R_L=10k\Omega \sim (V_{DD}-V_{SS}/2)$ $V_C=V_{DD}, V_{SS} \sim V_{DD}$ $V_{DD}=5V$		850	270	1050		1200	Ω	
		$V_{DD}=10V$		330	120	400		520	Ω	
		$V_{DD}=15V$		210	80	240		300	Ω	
"ON" Resistance Between Any 2 of 4 Switches	R_{ON}	$R_L=10k\Omega \sim (V_{DD}-V_{SS}/2)$ $V_C=V_{DD}, V_{IS}=V_{SS} \sim V_{DD}$ $V_{DD}=10V$ $V_{DD}=15V$			10 5			Ω Ω		
CONTROL INPUTS										
Low Level Input Voltage	V_{ILC}	$V_{IS}=V_{SS}$ and V_{DD} $V_{OS}=V_{DD}$ and V_{SS} $I_{IS}=\pm 10\mu A$ $V_{DD}=5V$		1.5	2.25	1.5		1.5	V	
		$V_{DD}=10V$		3.0	4.5	3.0		3.0	V	
		$V_{DD}=15V$		4.0	6.75	4.0		4.0	V	
HIGH Level Input Voltage	V_{IHC}	$V_{DD}=5V$	3.5		3.5	2.75		3.5	V	
		$V_{DD}=10V$ (Note 4)	7.0		7.0	5.5		7.0	V	
		$V_{DD}=15V$	11.0		11.0	8.25		11.0	V	
Input Current	I_{IN}	$V_{DD}-V_{SS}=15V$ $V_{DD} \quad V_{IS} \quad V_{SS}$ $V_{DD} \quad V_C \quad V_{SS}$		± 0.3		$\pm 10^{-5}$	± 0.3		± 1.0	μA

■ AC ELECTRICAL CHARACTERISTICS (AC Parameters are guaranteed by DC correlated testing)

($T_a=25^\circ\text{C}$, $t_r=t_f=20\text{ ns}$ and $V_{ss}=0\text{V}$ unless otherwise)

PARAMETER	SYMBOL	CONDITIONS	MIN	TYP	MAX	UNITS
Propagation Delay Time Signal Input to Signal Output	T_{PHL}, T_{PLH}	$V_c=V_{DD}, C_L=50\text{pF}$, (Figure 1) $R_L=200\text{k}$	$V_{DD}=5\text{V}$	25	55	ns
			$V_{DD}=10\text{V}$	15	35	ns
			$V_{DD}=15\text{V}$	10	25	ns
Propagation Delay Time Control Input to Signal Output High Impedance to Logical Level	t_{PZH}, t_{PLZ}	$R_L=1.0\text{k}\Omega, C_L=50\text{pF}$ (Figure 2, Figure 3)	$V_{DD}=5\text{V}$		125	ns
			$V_{DD}=10\text{V}$		60	ns
			$V_{DD}=15\text{V}$		50	ns
Propagation Delay Time Control Input to Signal Output Logical Level to High Impedance	t_{PHZ}, t_{PLZ}	$R_L=1.0\text{k}\Omega, C_L=50\text{pF}$, (Figure 2, Figure 3) $V_{DD}=5\text{V}$ $V_{DD}=10\text{V}$ $V_{DD}=15\text{V}$			125	ns
					60	ns
Sine Wave Distortion	t_{PHZ}, t_{PLZ}	$V_c=V_{DD}=5\text{V}, V_{ss}=-5\text{V}$ $R_L=10\text{k}\Omega, V_{IS}=5\text{V}_{P-P}, f=1\text{kHz}$, (Figure 4)		0.1	50	%
Frequency Response -Switch "ON" (Frequency at -3dB)	t_{PHZ}, t_{PLZ}	$V_c=V_{DD}=5\text{V}, V_{ss}=-5\text{V}$ $R_L=1\text{k}\Omega, V_{IS}=5\text{V}_{P-P}$ $20 \text{ Log}_{10} V_{OS}/V_{OS} (1\text{kHz})\text{-dB}$ (Figure 4)		40		MHz
Feedthrough - Switch "OFF" (Frequency at -50 dB)		$V_{DD}=5.0\text{V}, V_{CC}=V_{SS}=-5.0\text{V}$, $R_L=1\text{k}\Omega, V_{IS}=5.0\text{V}_{P-P}, 20\text{Log}_{10}$, $V_{OS}/V_{IS}=-50\text{dB}$, (Figure 4)		1.25		
Crosstalk Between Any Two Switches(Frequency at -50dB)		$V_{DD}=V_C(A)=5.0\text{V}; V_{SS}=V_C(B)=5.0\text{V}$, $R_L=1\text{k}\Omega, V_{IS}(A)=5.0\text{V}_{P-P}, 20\text{Log}_{10}$, $V_{OS}(B)/V_{IS}(A)=-50\text{dB}$ (Figure 5)		0.9		MHz
Crosstalk; Control Input to Signal Output		$V_{DD}=10\text{V}, R_L=10\text{k}\Omega, R_{IN}=1.0\text{k}\Omega$ $V_{CC}=10\text{V}$ Square Wave, $C_L=50\text{pF}$ (Figure 6)		150		mV_{P-P}
Maximum Control Input		$R_L=1.0\text{k}\Omega, C_L=50\text{pF}$, (Figure 7) $V_{OS}(f)=1/2V_{OS} (1.0\text{kHz})$ $V_{DD}=5.0\text{V}$ $V_{DD}=10\text{V}$ $V_{DD}=15\text{V}$		6.0		MHz
				8.0		MHz
				8.5		MHz
Signal Input Capacitance	C_{IS}			8.0		pF
Signal Output Capacitance	C_{OS}	$V_{DD}=10\text{V}$		8.0		pF
Feedthrough Capacitance	C_{IOS}	$V_C=0\text{V}$		0.5		pF
Control Input Capacitance	C_{IN}			5.0	7.5	pF

Note 1: These devices should not be connected to circuits with the power "ON"

Note 2: In all cases, there is approximately 5pF of probe and jig capacitance in the output; however, this capacitance is included in C_L wherever it is specified.

Note 3: V_{IS} is the voltage at the in/out pin and V_{OS} is the voltage at the out/in pin. V_c is the voltage at the control input.

Note 4: Conditions for V_{IHC} : (a) $V_{IS}=V_{DD}$, $I_{OS}=\text{standard B series } I_{OH}$. (b) $V_{IS}=0\text{V}$, $I_{OL}=\text{standard B series } I_{OL}$

■ SPECIAL CONSIDERATIONS

In applications where separate power sources are used to drive V_{DD} and the signal input, the V_{DD} current capability should exceed V_{DD}/R_L (R_L =effective external load of the UTC 4066 bilateral switches).This provision avoids any permanent current flow or clamp action of the V_{DD} supply when power is applied or removed from UTC 4066.

In certain applications, the external load-resistor current may include both V_{DD} and Signal-line components. To avoid drawing V_{DD} current when switch current flows into terminals 1,4,8 or 11,the voltage drop across the bidirectional swith must not exceed 0.6V at $T_a \leq 25$, or 0.4V at $T_a > 25$ (calculated from R_{ON} values shown).

NO V_{DD} current will flow through R_L if the switch current flows into terminals 2, 3, 9 or 10.

■ AC TEST CIRCUITS AND SWITCHING TIME WAVEFORMS

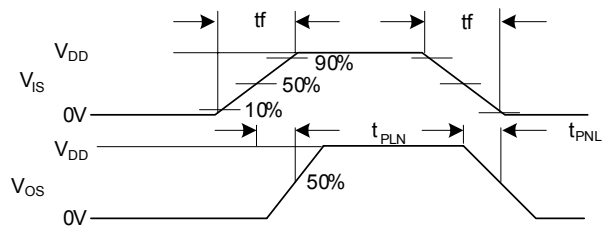
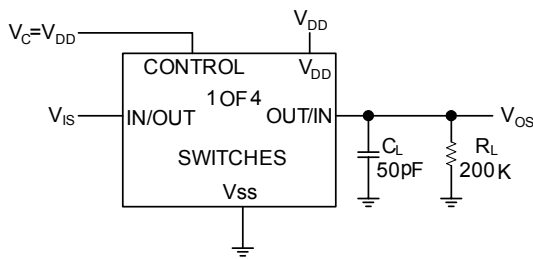

FIGURE 1. t_{PHL} , t_{PLH} Propagation Delay Time Signal Input to Signal Output

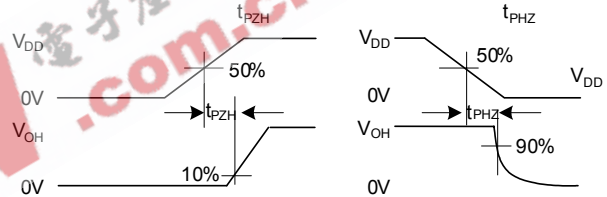
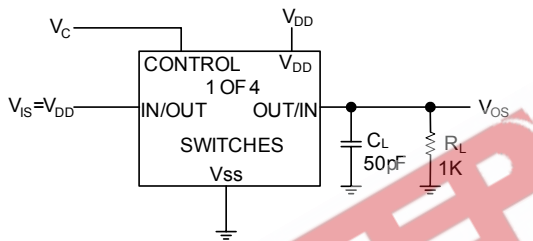

FIGURE 2. t_{PZH} , t_{PHZ} Propagation Delay Time Control to Signal Output

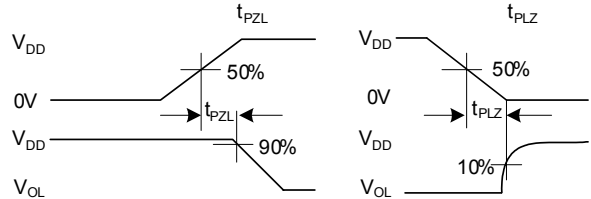
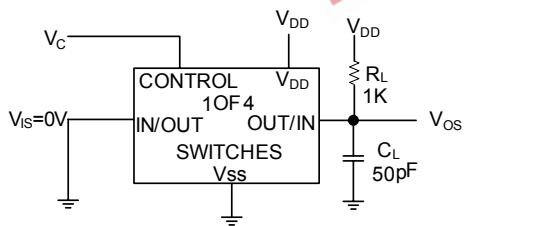
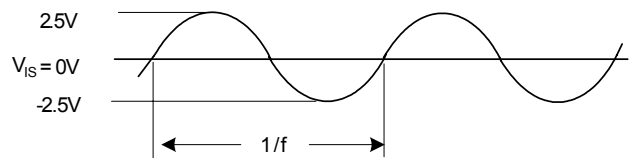
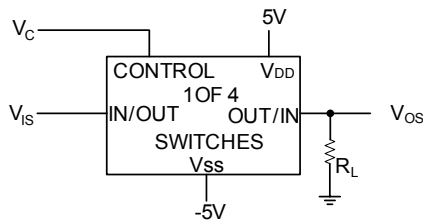

FIGURE 3. t_{PZL} , t_{PLZ} Propagation Delay Time Control to Signal Output



$V_C = V_{DD}$ for distortion and frequency response tests
 $V_C = V_{SS}$ for feedthrough test

FIGURE 4. Sine Wave Distortion, Frequency Response and Feedthrough

■ AC TEST CIRCUITS AND SWITCHING TIME WAVEFORMS(Cont.)

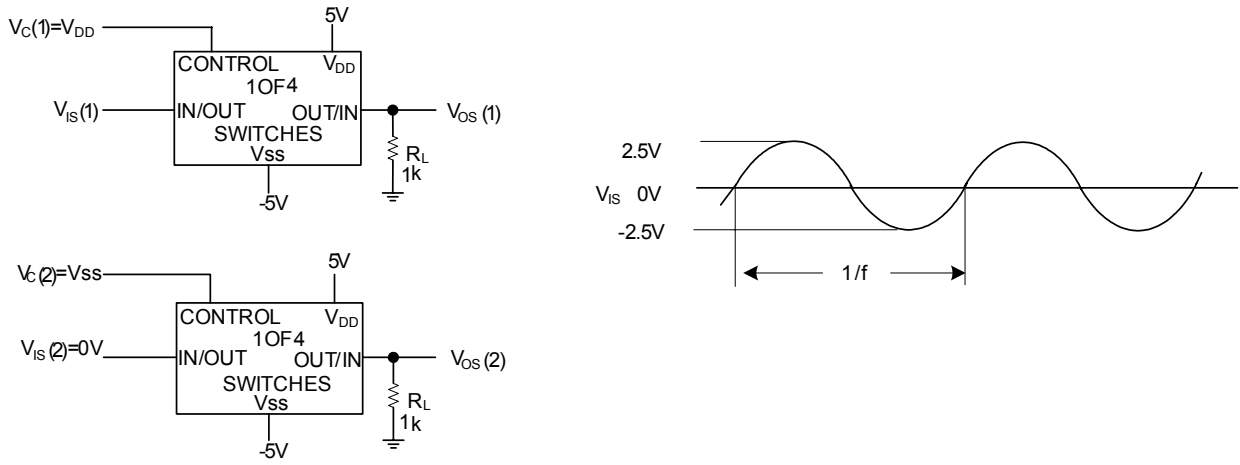

FIGURE 5. Crosstalk Between Any Two Switches

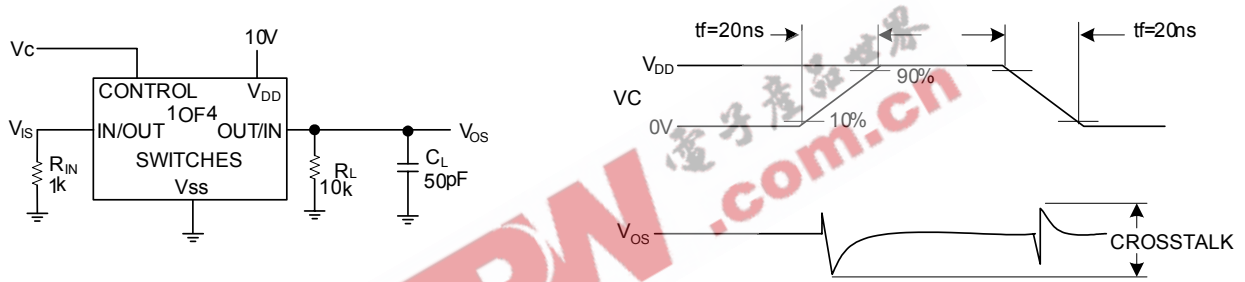

FIGURE 6. Crosstalk: Control Input to Signal Output

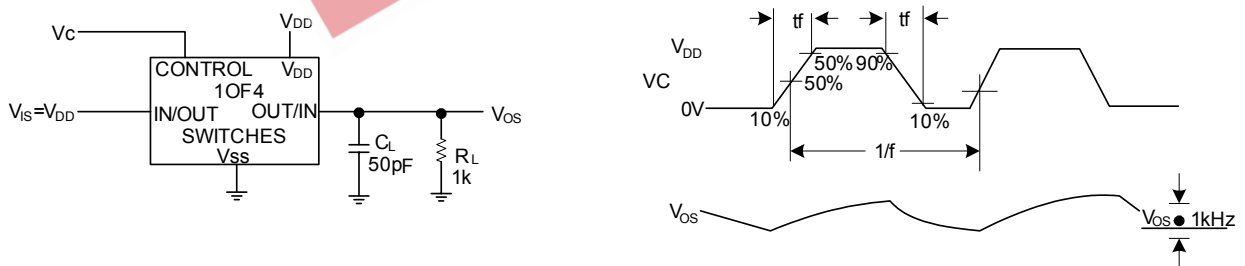
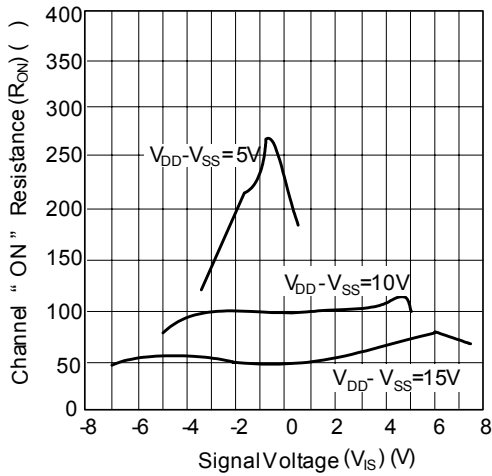

FIGURE 7. Maximum Control Input Frequency

■ TYPICAL PERFORMANCE CHARACTERISTICS

" ON " Resistance vs Signal Voltage for $T_a=25$



" ON " Resistance as a Function of emperature for $V_{DD}-V_{SS}=15V$

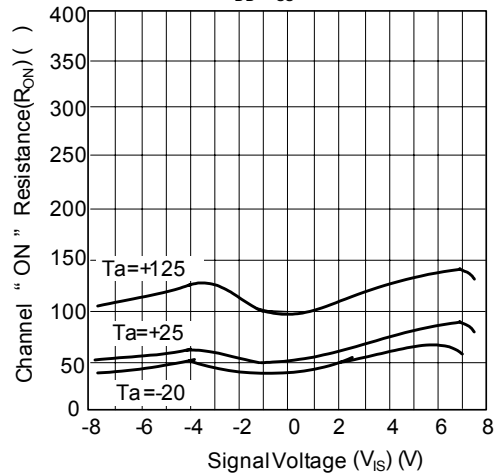

"ON" Resistance as a Function of Temperature for $V_{DD}-V_{SS}=10V$

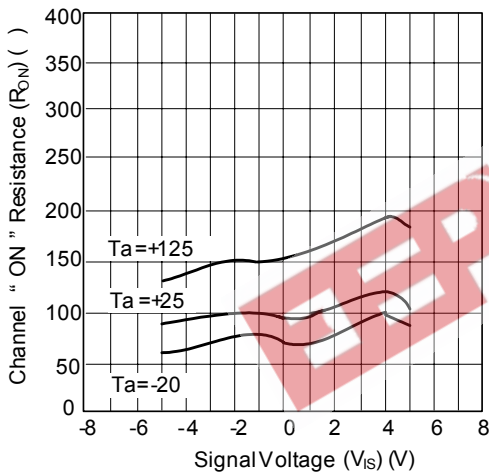

"ON" Resistance as a Function of Temperature for $V_{DD}-V_{SS}=15V$

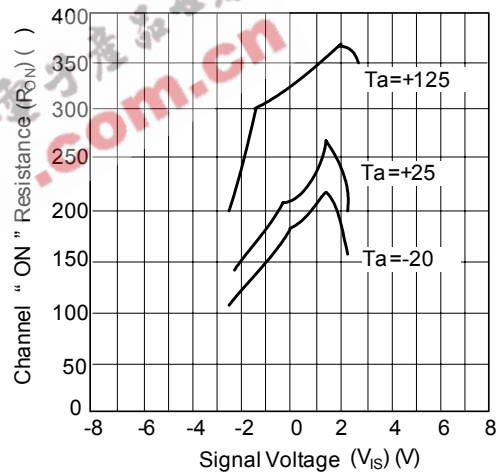

UTC assumes no responsibility for equipment failures that result from using products at values that exceed, even momentarily, rated values (such as maximum ratings, operating condition ranges, or other parameters) listed in products specifications of any and all UTC products described or contained herein. UTC products are not designed for use in life support appliances, devices or systems where malfunction of these products can be reasonably expected to result in personal injury. Reproduction in whole or in part is prohibited without the prior written consent of the copyright owner. The information presented in this document does not form part of any quotation or contract, is believed to be accurate and reliable and may be changed without notice.