

# PE4124

**High Linearity Quad MOSFET Mixer for GSM 800 & Cellular BTS**

### Features

- Integrated, single-ended RF & LO interfaces
- High linearity: IIP3 > +32 dBm, 820 - 920 MHz (+17 dBm LO)
- Low conversion loss: 6.9 dB (+17 dBm LO)
- High isolation: typical LO-RF at 43 dB, LO-IF at 31 dB
- Designed for low-side LO injection

### Product Description

The PE4124 is a high linearity, passive Quad MOSFET Mixer for GSM 800 & Cellular Base Station Receivers and exhibits high dynamic range performance over a broad LO drive range up to 20 dBm. This mixer integrates passive matching networks to provide single-ended interfaces for the RF and LO ports, eliminating the need for external RF baluns or matching networks. The PE4124 is optimized for frequency down-conversion using low-side LO injection for GSM 800 & Cellular Base Station applications, and is also suitable for use in up-conversion applications.

The PE4124 is manufactured on Peregrine's UltraCMOS™ process, a patented variation of silicon-on-insulator (SOI) technology on a sapphire substrate, offering the performance of GaAs with the economy and integration of conventional CMOS.

**Figure 1. Functional Diagram**

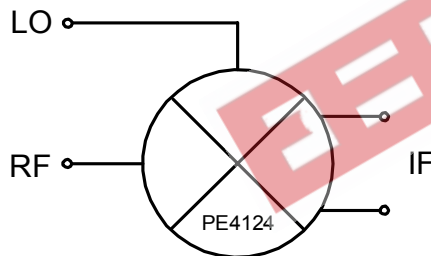

**Figure 2. Package Type**

8-lead TSSOP

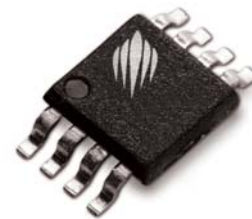

**Table 1. AC and DC Electrical Specifications @ +25 °C (Z<sub>S</sub> = Z<sub>L</sub> = 50 Ω)**

Parameter	Minimum	Typical	Maximum	Units
Frequency Range:				
LO	750	--	850	MHz
RF	820	--	920	MHz
IF <sup>1</sup>	--	70	--	MHz
Conversion Loss <sup>2</sup>		6.9	7.3	dB
Isolation:				
LO-RF	29	31		dB
LO-IF	38	43		dB
Input IP3	29	32.5		dBm
Input 1 dB Compression		23		dBm

Notes: 1. An IF frequency of 70 MHz is a nominal frequency. The IF frequency can be specified by the user as long as the RF and LO frequencies are within the specified maximum and minimum.

2. Conversion Loss includes loss of IF transformer (M/A COM ETC1-1-13, nominal loss 0.7dB at 70MHz).

\*Test conditions unless otherwise noted: LO = 70 MHz, LO input drive = 17 dBm, RF input drive = 3 dBm.

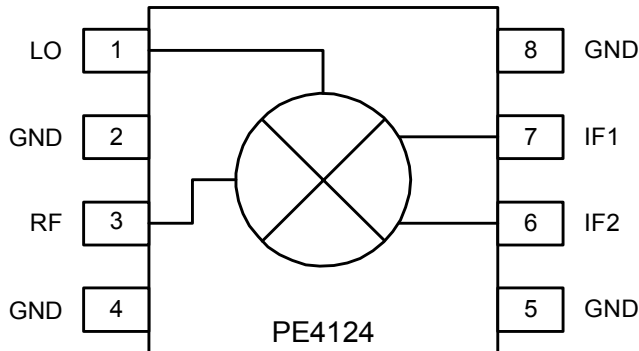
**Figure 3. Pin Configuration (Top View)**

**Table 2. Pin Descriptions**

Pin No.	Pin Name	Description
1	LO	LO Input
2	GND	Ground connection for Mixer. Traces should be physically short and connect immediately to ground plane for best performance.
3	RF	RF Input
4	GND	Ground.
5	GND	Ground.
6	IF2	IF differential output
7	IF1	IF differential output
8	GND	Ground.

**Table 3. Absolute Maximum Ratings**

Symbol	Parameter/Conditions	Min	Max	Units
$T_{ST}$	Storage temperature range	-65	150	°C
$T_{OP}$	Operating temperature range	-40	85	°C
$P_{LO}$	LO input power		20	dBm
$P_{RF}$	RF input power		16	dBm
$V_{ESD}$	ESD Sensitive Device		250	V

Absolute Maximum Ratings are those values listed in the above table. Exceeding these values may cause permanent device damage. Functional operation should be restricted to the limits in the DC Electrical Specifications table. Exposure to absolute maximum ratings for extended periods may affect device reliability.

#### Electrostatic Discharge (ESD) Precautions

When handling this UltraCMOS™ device, observe the same precautions that you would use with other ESD-sensitive devices. Although this device contains circuitry to protect it from damage due to ESD, precautions should be taken to avoid exceeding the rating specified.

#### Latch-Up Avoidance

Unlike conventional CMOS devices, UltraCMOS™ devices are immune to latch-up.

**Evaluation Kit**

**Figure 4. Evaluation Board Layout**  
Peregrine Specification 101/0054

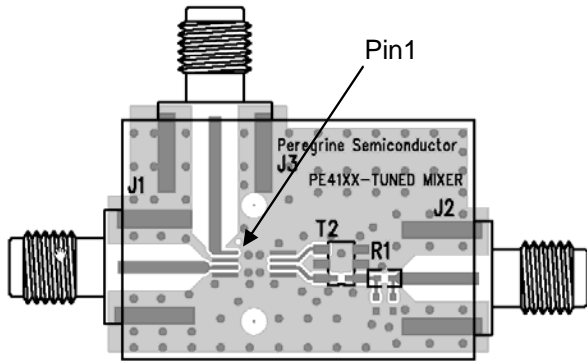

**Table 4. Bill of Materials**

Reference	Value / Description
T2	M/A Com ETC1-1-13
U1 (Not Labeled)	PE4124 Mixer
R1	0Ω
J1, J2, J3	SMA Connector

**Applications Support**

If you have a problem with your evaluation kit or if you have applications questions, please contact applications support:

E-Mail: [help@psemi.com](mailto:help@psemi.com) (fastest response)  
Phone: (858) 731-9400

**Figure 5. Evaluation Board Schematic Diagram**

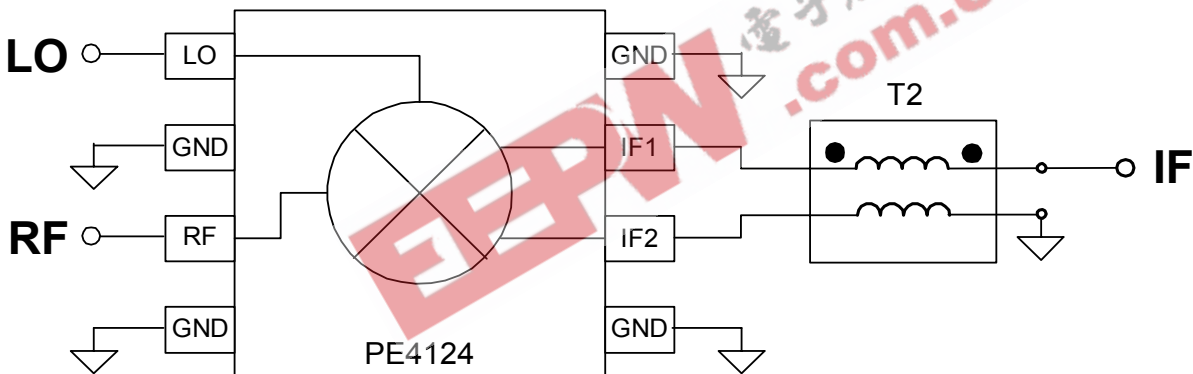

T2 M/A-Com E-Series RF 1:1 Transformer ETC1-1-13

**Figure 6. Evaluation Board Testing Block Diagram, 2-Tone Setup**

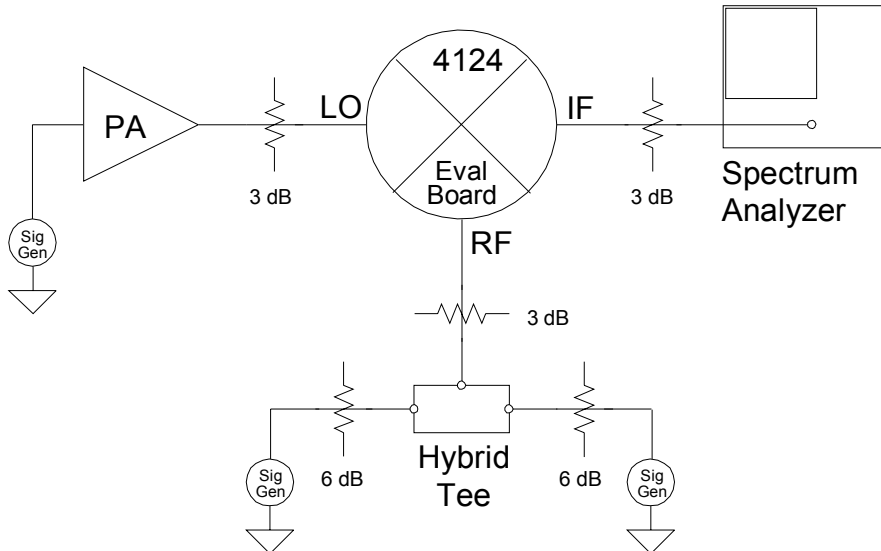

Typical Performance Plots (LO=17 dBm, RF=3 dBm, IF=70 MHz)

Figure 7. Conversion Loss vs. Frequency

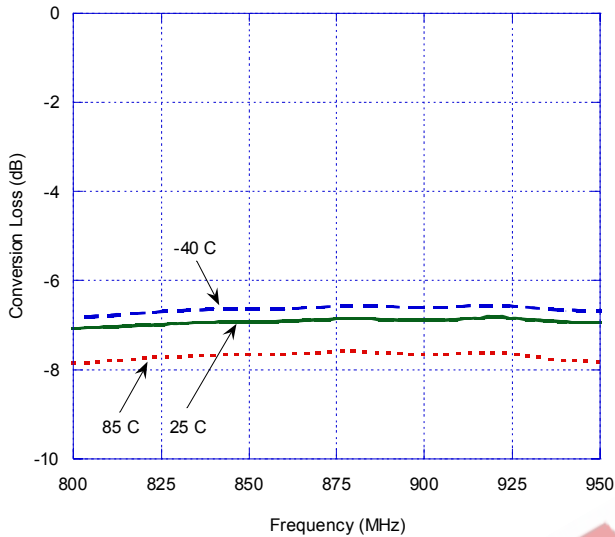

Figure 8. Input 1dB Compression vs. Frequency

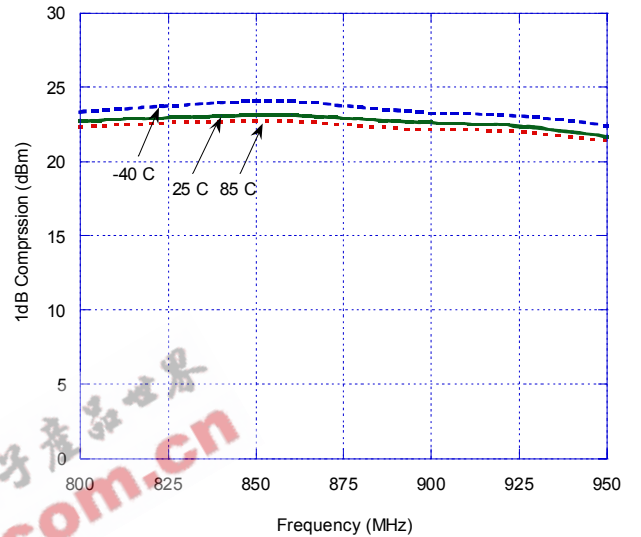

Figure 9. Input IP3 vs. Frequency

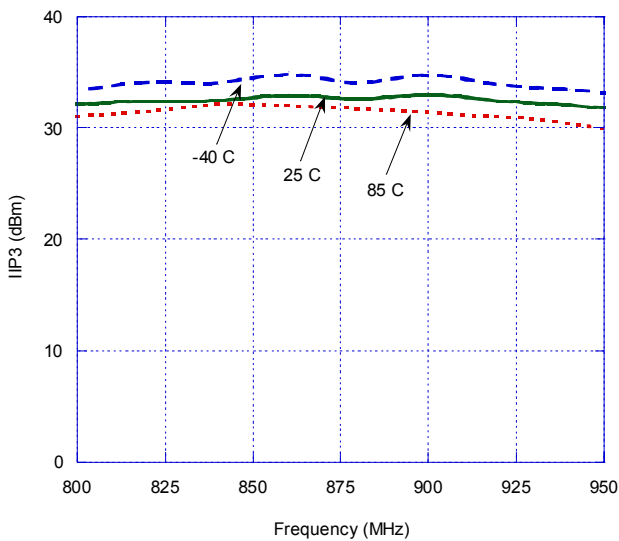
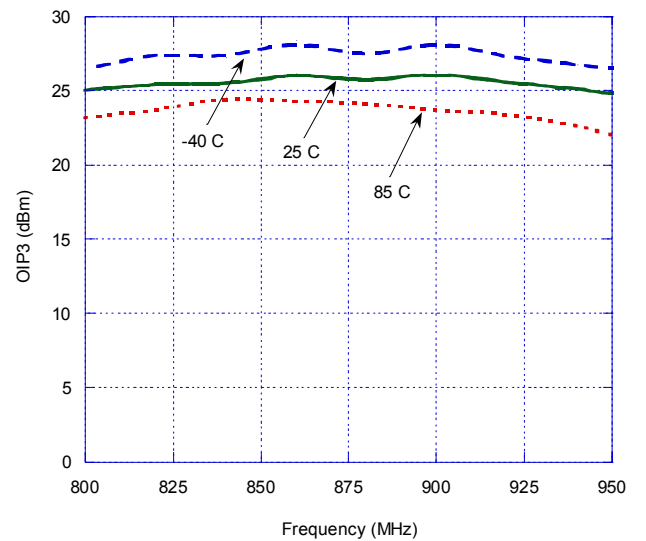

Figure 10. Output IP3 vs. Frequency



Typical Performance Plots (LO=17 dBm, RF=3 dBm, IF=70 MHz)

Figure 11. LO-RF Isolation vs. Frequency

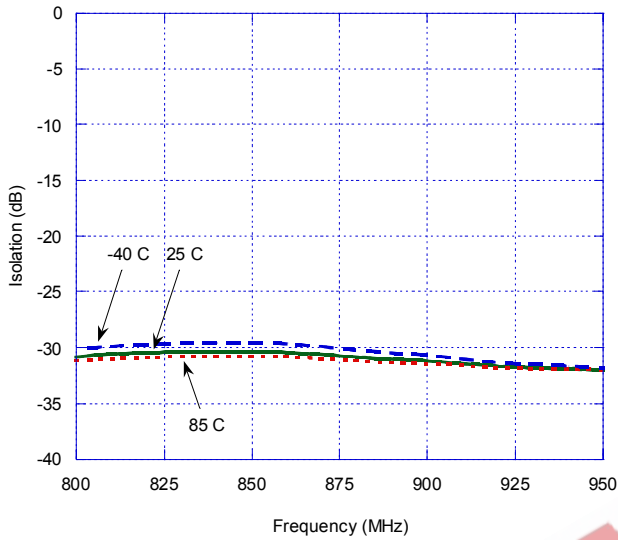

Figure 12. LO-IF Isolation vs. Frequency

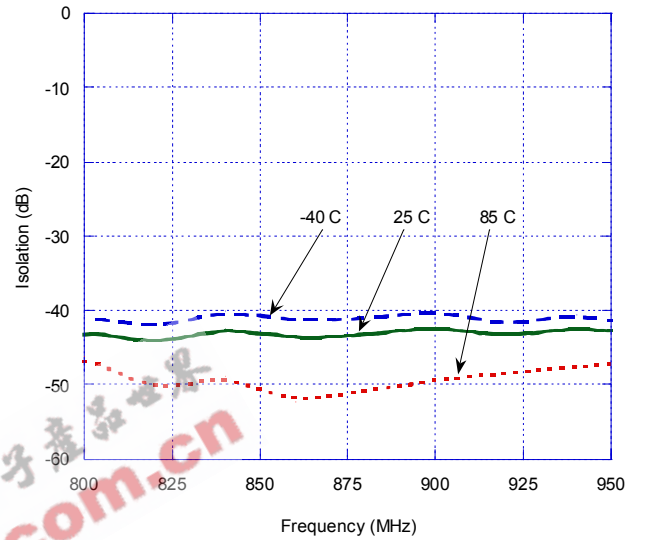

Figure 13. LO Port Return Loss vs. Frequency

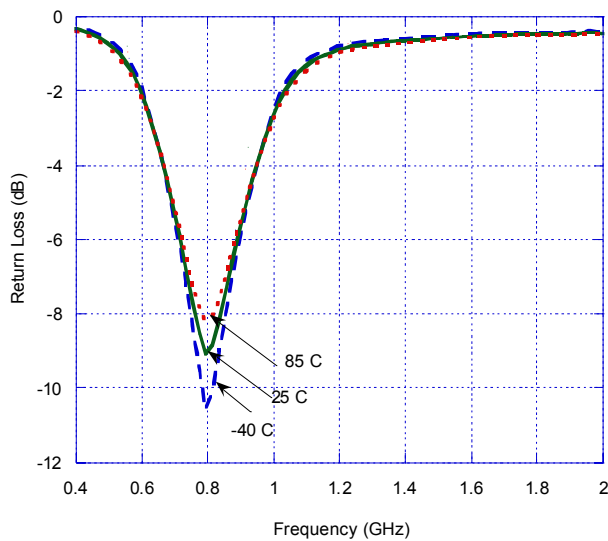
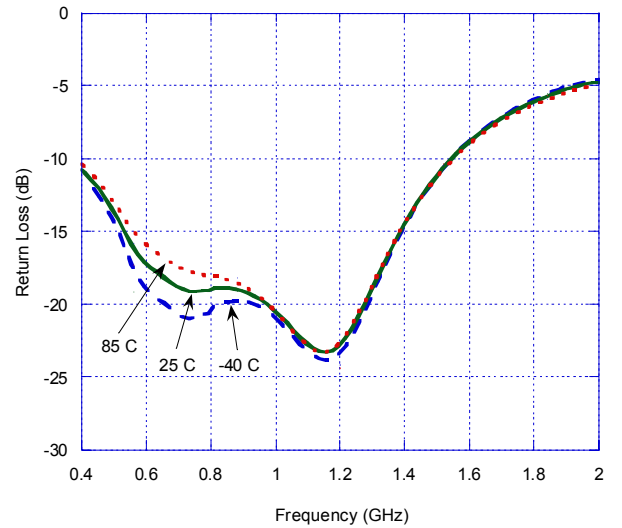

Figure 14. RF Port Return Loss vs. Frequency



Typical Performance Data @ +25 °C (RF=3 dBm, IF=70 MHz)

Figure 15. Input IP3 across LO Drive

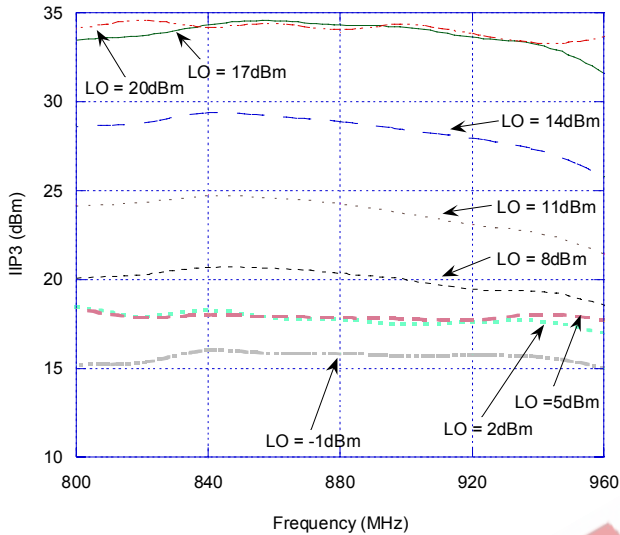

Figure 16. Conversion Loss across LO Drive

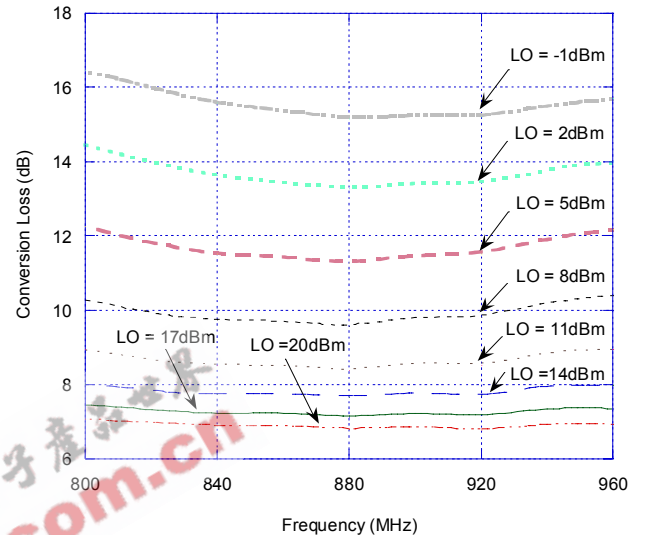

Table 5. Spurious Response

mF <sub>RF</sub>	mF <sub>RF</sub> + nF <sub>LO</sub>				
	nF <sub>LO</sub>				
	0	1	2	3	4
0	--	30	22	33	28
1	28	2	32	23	39
2	50	48	47	64	52
3	>85	65	73	63	74
4	>85	>85	>85	>85	>85

Normalized to dB below P<sub>1F</sub>  
(RF=870 MHz @ 3 dBm, LO = 800 MHz @ 17 dBm, low side)

Table 6. Spurious Response

mF <sub>RF</sub>	mF <sub>RF</sub> - nF <sub>LO</sub>				
	nF <sub>LO</sub>				
	0	1	2	3	4
0	--	30	22	33	28
1	28	0	29	13	39
2	50	46	52	54	48
3	>85	63	75	76	71
4	>85	>85	>85	>85	>85

Normalized to dB below P<sub>1F</sub>  
(RF=870 MHz @ 3 dBm, LO = 800 MHz @ 17 dBm, low side)

**Figure 17. Package Drawing**

8-lead TSSOP

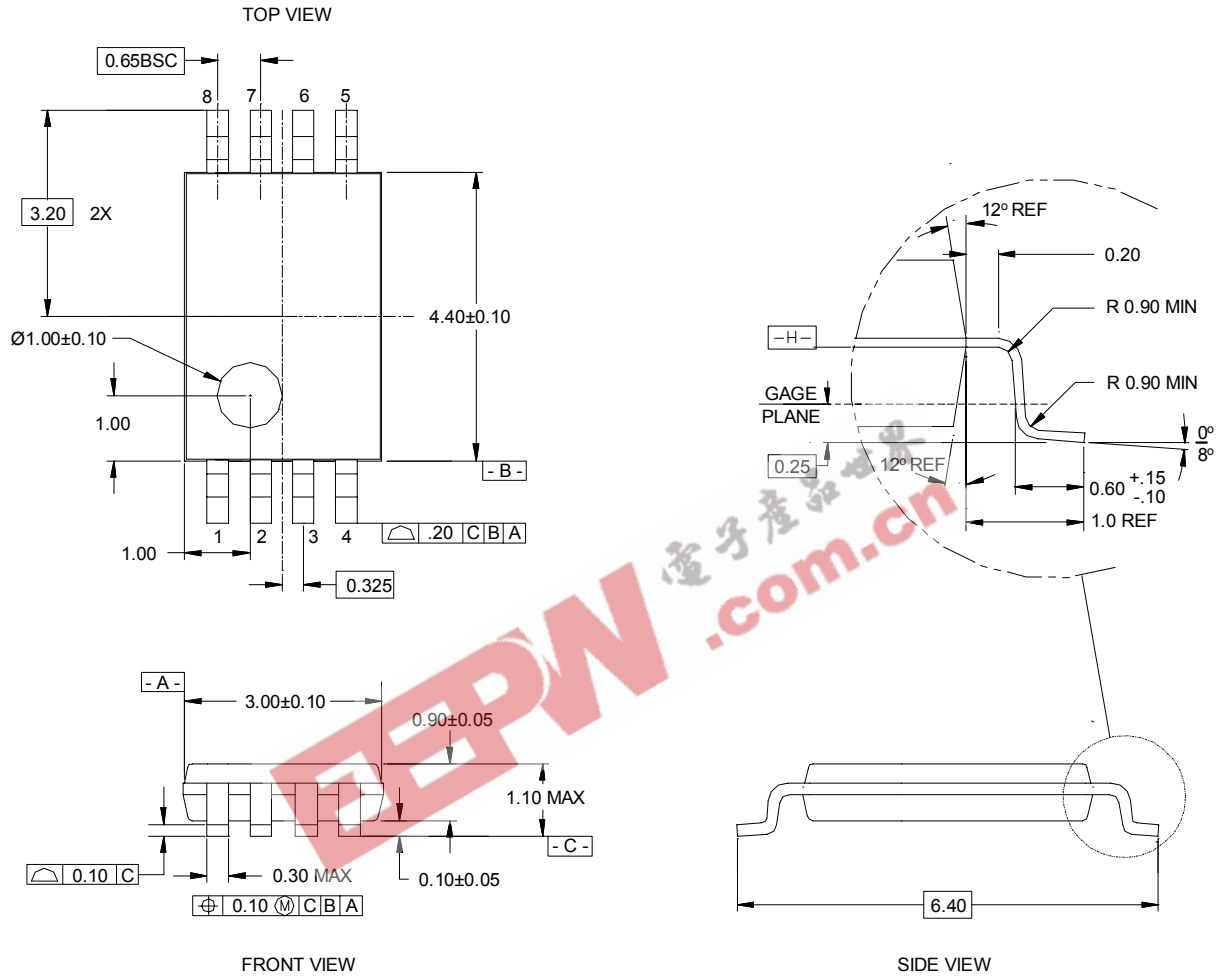

**Table 7. Ordering Information**

Order Code	Part Marking	Description	Package	Shipping Method
4124-21	4124	PE4124-08TSSOP-100A	8-lead TSSOP	100 units / Tube
4124-22	4124	PE4124-08TSSOP-2000C	8-lead TSSOP	2000 units / T&R
4124-00	PE4124-EK	PE4124-08TSSOP-EK	Evaluation Board	1 / Box

## Sales Offices

### *The Americas*

#### **Peregrine Semiconductor Corporation**

9450 Carroll Park Drive  
San Diego, CA 92121  
Tel 858-731-9400  
Fax 858-731-9499

### *Europe*

#### **Peregrine Semiconductor Europe**

Bâtiment Maine  
13-15 rue des Quatre Vents  
F- 92380 Garches, France  
Tel: +33-1-47-41-91-73  
Fax : +33-1-47-41-91-73

### **Space and Defense Products**

#### **Americas:**

Tel: 505-881-0438  
Fax: 505-881-0443

#### **Europe, Asia Pacific:**

180 Rue Jean de Guiramand  
13852 Aix-En-Provence cedex 3, France  
Tel: +33(0) 4 4239 3361  
Fax: +33(0) 4 4239 7227

### *North Asia Pacific*

#### **Peregrine Semiconductor K.K.**

5A-5, 5F Imperial Tower  
1-1-1 Uchisaiwaicho, Chiyoda-ku  
Tokyo 100-0011 Japan  
Tel: +81-3-3502-5211  
Fax: +81-3-3502-5213

#### **Peregrine Semiconductor, Korea**

#B-2402, Kolon Tripolis, #210  
Geumgok-dong, Bundang-gu, Seongnam-si,  
Gyeonggi-do, 463-480 S. Korea  
Tel: +82-31-728-4300  
Fax: +82-31-728-4305

### *South Asia Pacific*

#### **Peregrine Semiconductor, China**

Shanghai, 200040, P.R. China  
Tel: +86-21-5836-8276  
Fax: +86-21-5836-7652

For a list of representatives in your area, please refer to our Web site at: [www.psemi.com](http://www.psemi.com)

## Data Sheet Identification

### **Advance Information**

The product is in a formative or design stage. The data sheet contains design target specifications for product development. Specifications and features may change in any manner without notice.

### **Preliminary Specification**

The data sheet contains preliminary data. Additional data may be added at a later date. Peregrine reserves the right to change specifications at any time without notice in order to supply the best possible product.

### **Product Specification**

The data sheet contains final data. In the event Peregrine decides to change the specifications, Peregrine will notify customers of the intended changes by issuing a DCN (Document Change Notice).

The information in this data sheet is believed to be reliable. However, Peregrine assumes no liability for the use of this information. Use shall be entirely at the user's own risk.

No patent rights or licenses to any circuits described in this data sheet are implied or granted to any third party.

Peregrine's products are not designed or intended for use in devices or systems intended for surgical implant, or in other applications intended to support or sustain life, or in any application in which the failure of the Peregrine product could create a situation in which personal injury or death might occur. Peregrine assumes no liability for damages, including consequential or incidental damages, arising out of the use of its products in such applications.

The Peregrine name, logo, and UTSi are registered trademarks and UltraCMOS and HaRP are trademarks of Peregrine Semiconductor Corp.