

FEATURES

- 3.3µH to 330µH
- Surface Mounting
- Up to 5.20A IDC
- UL 94V-0 Package Materials
- Compact Size
- Toroidal Construction giving Low Leakage Flux
- Pick & Place Compatible

DESCRIPTION

The 4000 series is a range of surface mount toroidal inductors designed for use in switching power supplies and DC/DC converters. The parts are ideal for applications requiring low profile compact components in a surface mount package.

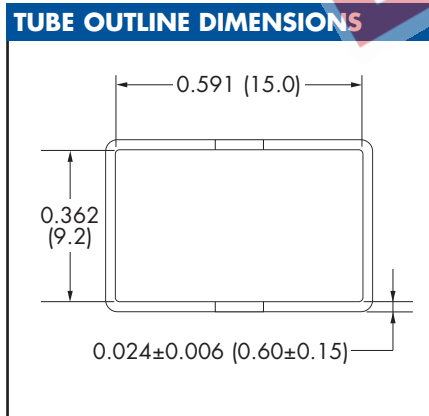

SELECTION GUIDE

	Nominal Inductance	Inductance Range	DC Resistance	DC Current Continuous
Order Code	µH 10kHz rms 10mV AC	µH 10kHz rms 10mV AC	mΩ MAX	A MAX
403R3	3.3	2.4 - 3.9	17	5.20
404R7	4.7	3.7 - 6.1	19	4.40
406R8	6.8	5.3 - 8.8	20	3.60
40100	10	7.2 - 12.0	23	3.00
40150	15	11.9 - 19.8	30	2.40
40220	22	16.2 - 27.0	35	2.10
40330	33	24.8 - 41.4	54	1.66
40470	47	35.3 - 58.9	79	1.42
40680	68	50.3 - 83.9	148	1.20
40101	100	74.4 - 124	177	0.94
40151	150	115 - 192	273	0.76
40221	220	165 - 275	405	0.67
40331	330	247 - 412	610	0.54

PACKAGE DETAILS

Order Code	TYP Weight (g)	Packaging Style	QTY
40XXX	3.2	Tube	30

MECHANICAL DIMENSIONS

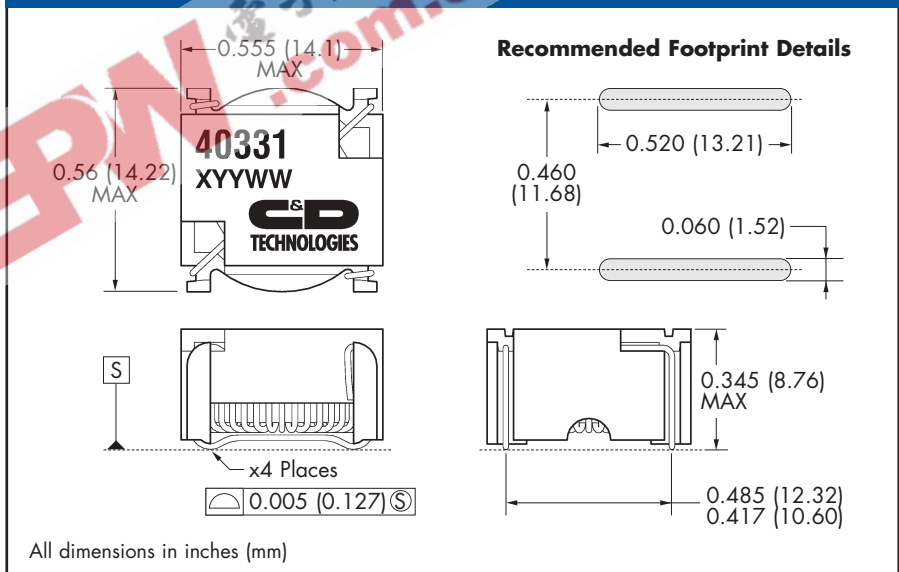

ABSOLUTE MAXIMUM RATINGS

Operating free air temperature range	-40°C to 85°C
Storage temperature range	-40°C to 125°C

C&D Technologies (NCL) Ltd
Tanners Drive, Blakelands North
Milton Keynes MK14 5BU, England
Tel: +44 (0)1908 615232
Fax: +44 (0)1908 617545
email: info@cdtechno-ncl.com

C&D Technologies Inc.
3400 E Britannia Drive, Tucson,
Arizona 85706, USA
Tel: +1 (800) 547-2537
Fax: +1 (520) 741-4598
email: sales@cdtechno.com

C&D Technologies (NCL) Limited reserve the right to alter or improve the specification, internal design or manufacturing process at any time, without notice. Please check with your supplier or visit our web site to ensure that you have the current and complete specification for your product before use.

© C&D Technologies (NCL) Limited 2003 NMP 4000.1

No part of this publication may be copied, transmitted or stored in a retrieval system or reproduced in any way including, but not limited to, photography, photocopy, magnetic or other recording means, without prior written permission from C&D Technologies (NCL) Limited.

Instructions for use are available from: www.cdpoweronline.com