

**Major Ratings and Characteristics**

Characteristics	401CMQ...	Units
$I_{F(AV)}$ Rectangular waveform	400	A
$V_{RRM}$ range	35 to 45	V
$I_{FSM}$ @tp = 5 $\mu$ s sine	25,000	A
$V_F$ @200Apk, $T_J = 125^\circ\text{C}$ (per leg)	0.56	V
$T_J$ range	-55 to 175	$^\circ\text{C}$

**Description/Features**

The 401CMQ center tap, high current, Schottky rectifier module series has been optimized for low reverse leakage at high temperature. The proprietary barrier technology allows for reliable operation up to 175 $^\circ\text{C}$  junction temperature. Typical applications are in high current switching power supplies, converters, free-wheeling diodes, welding and reverse battery protection.

- 175 $^\circ\text{C}$   $T_J$  operation
- Center tap module
- High purity, high temperature epoxy encapsulation for enhanced mechanical strength and moisture resistance
- Low forward voltage drop
- High frequency operation
- Guard ring for enhanced ruggedness and long term reliability

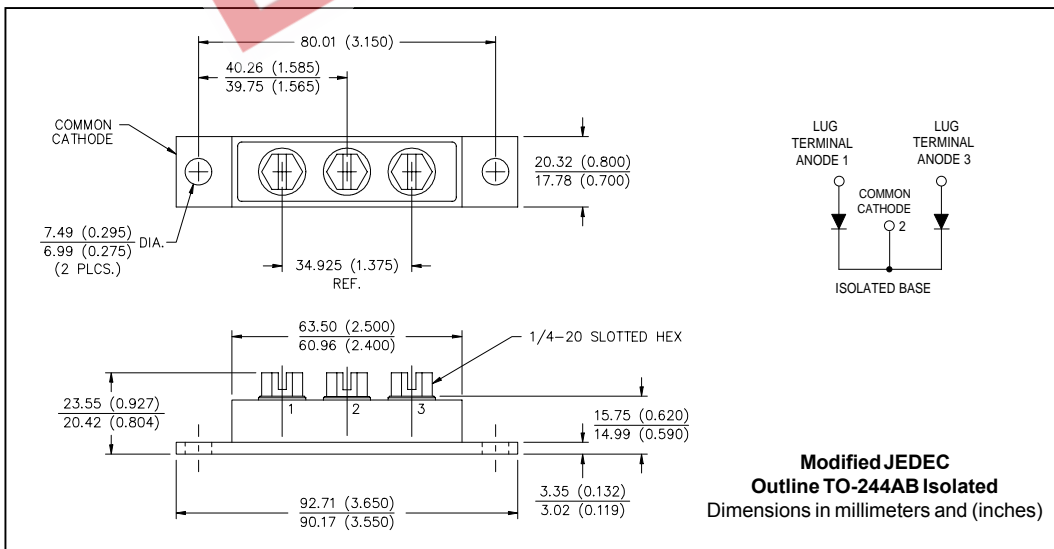

## Voltage Ratings

Partnumber	401CMQ035	401CMQ040	401CMQ045
$V_R$ Max. DC Reverse Voltage (V)	35	40	45
$V_{RWM}$ Max. Working Peak Reverse Voltage (V)			

## Absolute Maximum Ratings

Parameters	401CMQ	Units	Conditions
$I_{F(AV)}$ Max. Average Forward Current (Per Leg) * See Fig. 5 (Per Device)	200 400	A	50% duty cycle @ $T_C = 116^\circ\text{C}$ , rectangular waveform
$I_{FSM}$ Max. Peak One Cycle Non-Repetitive Surge Current (Per Leg) * See Fig. 7	25,000 3450	A	5 $\mu\text{s}$ Sine or 3 $\mu\text{s}$ Rect. pulse 10ms Sine or 6ms Rect. pulse Following any rated load condition and with rated $V_{RWM}$ applied
$E_{AS}$ Non-Repetitive Avalanche Energy (Per Leg)	270	mJ	$T_J = 25^\circ\text{C}$ , $I_{AS} = 40$ Amps, $L = 0.34$ mH
$I_{AR}$ Repetitive Avalanche Current (Per Leg)	40	A	Current decaying linearly to zero in 1 $\mu\text{sec}$ Frequency limited by $T_J$ max. $V_A = 1.5 \times V_R$ typical

## Electrical Specifications

Parameters	401CMQ	Units	Conditions
$V_{FM}$ Max. Forward Voltage Drop (Per Leg) * See Fig. 1 (1)	0.67	V	@ 200A
	0.78	V	@ 400A
	0.56	V	@ 200A
	0.68	V	@ 400A
$I_{RM}$ Max. Reverse Leakage Current (Per Leg) * See Fig. 2 (1)	20	mA	$T_J = 25^\circ\text{C}$
	180	mA	$T_J = 125^\circ\text{C}$
$C_T$ Max. Junction Capacitance (Per Leg)	10,300	pF	$V_R = 5V_{DC}$ , (test signal range 100Khz to 1Mhz) $25^\circ\text{C}$
$L_S$ Typical Series Inductance (Per Leg)	5.0	nH	From top of terminal hole to mounting plane
$dv/dt$ Max. Voltage Rate of Change	10000	V/ $\mu\text{s}$	(Rated $V_R$ )
$V_{RMS}$ Insulation Voltage	1000	V	

(1) Pulse Width < 300 $\mu\text{s}$ , Duty Cycle < 2%

## Thermal-Mechanical Specifications

Parameters	401CMQ	Units	Conditions
$T_J$ Max. Junction Temperature Range	-55 to 175	$^\circ\text{C}$	
$T_{stg}$ Max. Storage Temperature Range	-55 to 175	$^\circ\text{C}$	
$R_{thJC}$ Max. Thermal Resistance Junction to Case (Per Leg)	0.4	$^\circ\text{C}/\text{W}$	DC operation * See Fig. 4
$R_{thJC}$ Max. Thermal Resistance Junction to Case (Per Package)	0.2	$^\circ\text{C}/\text{W}$	DC operation
$R_{thCS}$ Typical Thermal Resistance, Case to Heatsink	0.1	$^\circ\text{C}/\text{W}$	Mounting surface, smooth and greased
wt Approximate Weight	79 (2.80)	g (oz.)	
T Mounting Torque	Min.	24 (20)	Kg-cm (lbf-in)
	Max.	35 (30)	
	Typ.	13.5 (12)	
	Terminal Torque	Min. 35 (30) Max. 46 (40)	
Case Style	TO-244AB isolated		Modified JEDEC

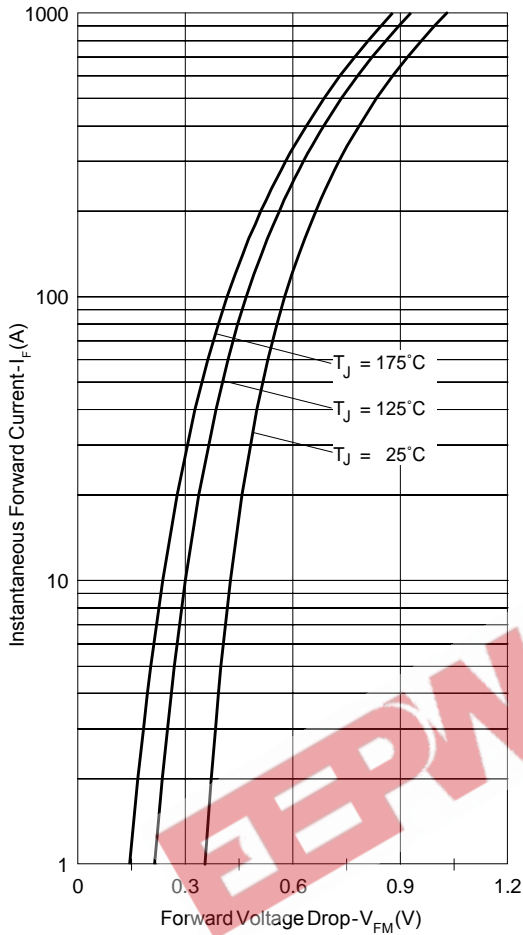

Fig. 1 - Max. Forward Voltage Drop Characteristics

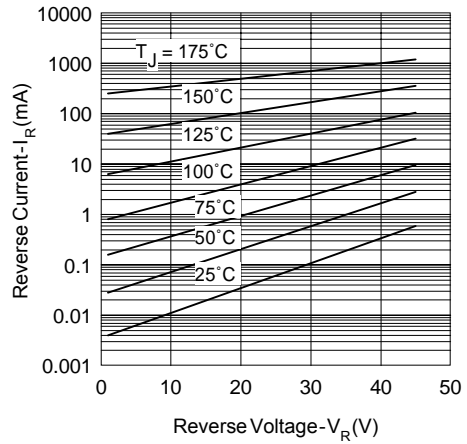

Fig. 2 - Typical Values Of Reverse Current Vs. Reverse Voltage

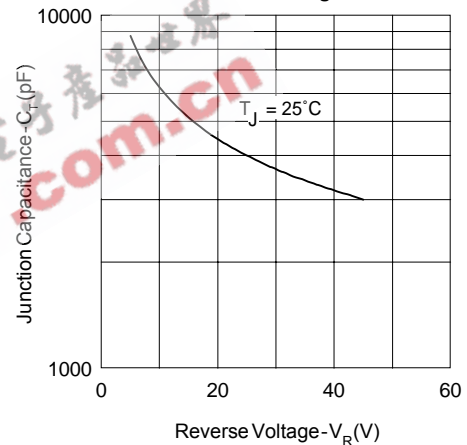

Fig. 3 - Typical Junction Capacitance Vs. Reverse Voltage

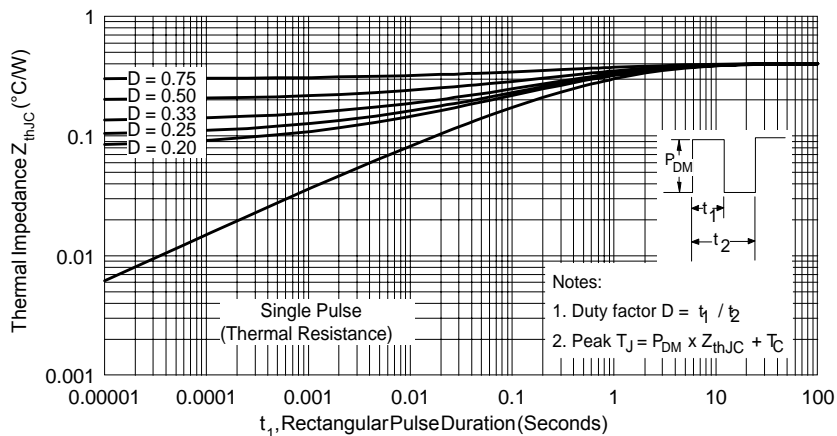

Fig. 4 - Max. Thermal Impedance  $Z_{thJC}$  Characteristics (Per Leg)

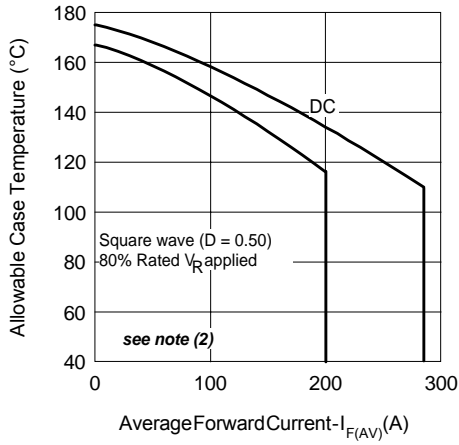

Fig. 5 - Max. Allowable Case Temperature Vs. Average Forward Current

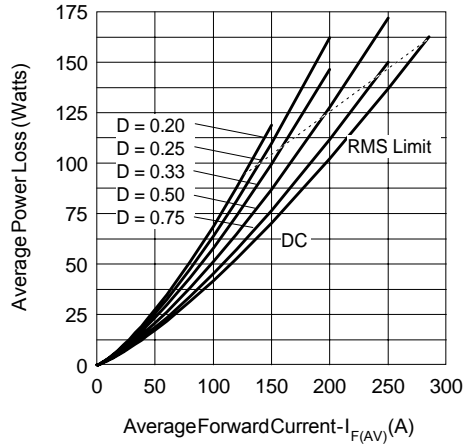

Fig. 6 - Forward Power Loss Characteristics

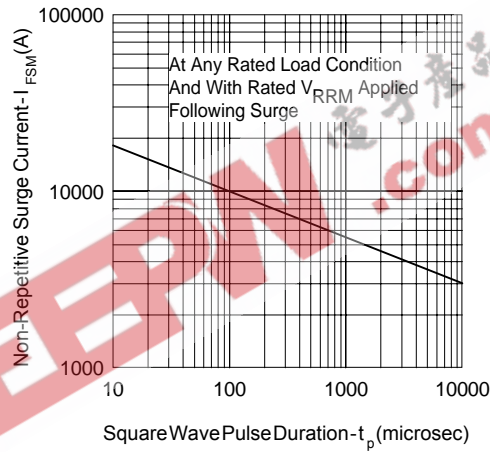

Fig. 7 - Max. Non-Repetitive Surge Current

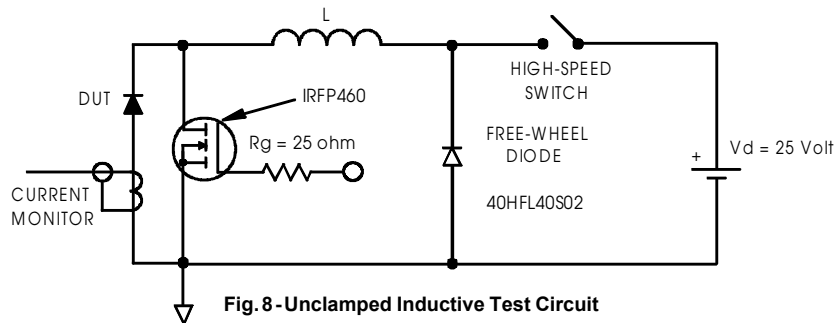

Fig. 8 - Unclamped Inductive Test Circuit

(2) Formula used:  $T_C = T_J - (Pd + Pd_{REV}) \times R_{thJC}$ ;

$Pd$  = Forward Power Loss =  $I_{F(AV)} \times V_{FM} @ (I_{F(AV)} / D)$  (see Fig. 6);

$Pd_{REV}$  = Inverse Power Loss =  $V_{R1} \times I_R (1 - D)$ ;  $I_R @ V_{R1} = 80\%$  rated  $V_R$

Ordering Information Table

**Device Code**

401	C	M	Q	045
①	②	③	④	⑤

<b>1</b>	-	Current Rating: 400A
<b>2</b>	-	Common Cathode
<b>3</b>	-	Module
<b>4</b>	-	Schottky Q Series
<b>5</b>	-	Voltage Rating: _____

035 = 35V  
 040 = 40V  
 045 = 45V

EEPW.com.cn 电子產品世界

Data and specifications subject to change without notice.  
 This product has been designed and qualified for Industrial Level.  
 Qualification Standards can be found on IR's Web site.