

PE4124

High Linearity Quad MOSFET Mixer for GSM 800 & Cellular BTS

Features

- Integrated, single-ended RF & LO interfaces
- High linearity: IIP3 > +32 dBm, 820 - 920 MHz (+17 dBm LO)
- Low conversion loss: 6.9 dB (+17 dBm LO)
- High isolation: typical LO-IF at 43 dB, LO-RF at 31 dB
- Designed for low-side LO injection

Product Description

The PE4124 is a high linearity, passive Quad MOSFET Mixer for GSM 800 & Cellular Base Station Receivers and exhibits high dynamic range performance over a broad LO drive range up to 20 dBm. This mixer integrates passive matching networks to provide single-ended interfaces for the RF and LO ports, eliminating the need for external RF baluns or matching networks. The PE4124 is optimized for frequency down-conversion using low-side LO injection for GSM 800 & Cellular Base Station applications, and is also suitable for use in up-conversion applications.

The PE4124 is manufactured on Peregrine's UltraCMOS™ process, a patented variation of silicon-on-insulator (SOI) technology on a sapphire substrate, offering the performance of GaAs with the economy and integration of conventional CMOS.

Figure 1. Functional Diagram

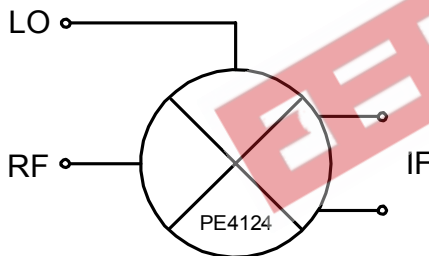

Figure 2. Package Type

8-lead TSSOP

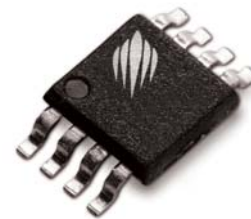

Table 1. AC and DC Electrical Specifications @ +25 °C (Z_S = Z_L = 50 Ω)

Parameter	Minimum	Typical	Maximum	Units
Frequency Range:				
LO	750	--	850	MHz
RF	820	--	920	MHz
IF ¹	--	70	--	MHz
Conversion Loss ²		6.9	7.3	dB
Isolation:				
LO-RF	29	31		dB
LO-IF	38	43		dB
Input IP3	29	32.5		dBm
Input 1 dB Compression		23		dBm

Notes: 1. An IF frequency of 70 MHz is a nominal frequency. The IF frequency can be specified by the user as long as the RF and LO frequencies are within the specified maximum and minimum.

2. Conversion Loss includes loss of IF transformer (M/A COM ETC1-1-13, nominal loss 0.7dB at 70MHz).

*Test conditions unless otherwise noted: LO = 70 MHz, LO input drive = 17 dBm, RF input drive = 3 dBm.

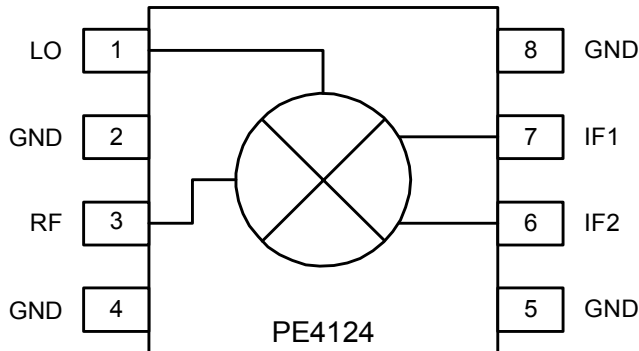
Figure 3. Pin Configuration (Top View)

Table 2. Pin Descriptions

Pin No.	Pin Name	Description
1	LO	LO Input
2	GND	Ground connection for Mixer. Traces should be physically short and connect immediately to ground plane for best performance.
3	RF	RF Input
4	GND	Ground.
5	GND	Ground.
6	IF2	IF differential output
7	IF1	IF differential output
8	GND	Ground.

Table 3. Absolute Maximum Ratings

Symbol	Parameter/Conditions	Min	Max	Units
T_{ST}	Storage temperature range	-65	150	°C
T_{OP}	Operating temperature range	-40	85	°C
P_{LO}	LO input power		20	dBm
P_{RF}	RF input power		16	dBm
V_{ESD}	ESD Sensitive Device		250	V

Absolute Maximum Ratings are those values listed in the above table. Exceeding these values may cause permanent device damage. Functional operation should be restricted to the limits in the DC Electrical Specifications table. Exposure to absolute maximum ratings for extended periods may affect device reliability.

Electrostatic Discharge (ESD) Precautions

When handling this UltraCMOS™ device, observe the same precautions that you would use with other ESD-sensitive devices. Although this device contains circuitry to protect it from damage due to ESD, precautions should be taken to avoid exceeding the rating specified.

Latch-Up Avoidance

Unlike conventional CMOS devices, UltraCMOS™ devices are immune to latch-up.

Evaluation Kit

Figure 4. Evaluation Board Layout
Peregrine Specification 101/0054

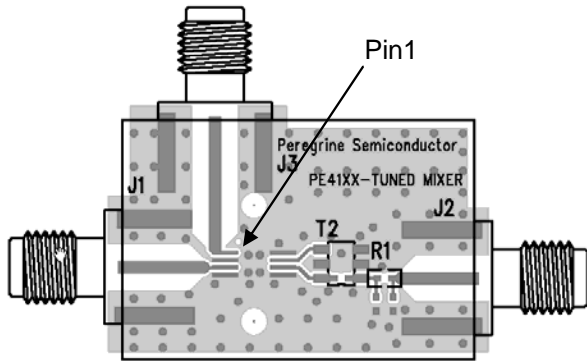

Table 4. Bill of Materials

Reference	Value / Description
T2	M/A Com ETC1-1-13
U1 (Not Labeled)	PE4124 Mixer
R1	0Ω
J1, J2, J3	SMA Connector

Applications Support

If you have a problem with your evaluation kit or if you have applications questions, please contact applications support:

E-Mail: help@psemi.com (fastest response)
Phone: (858) 731-9400

Figure 5. Evaluation Board Schematic Diagram

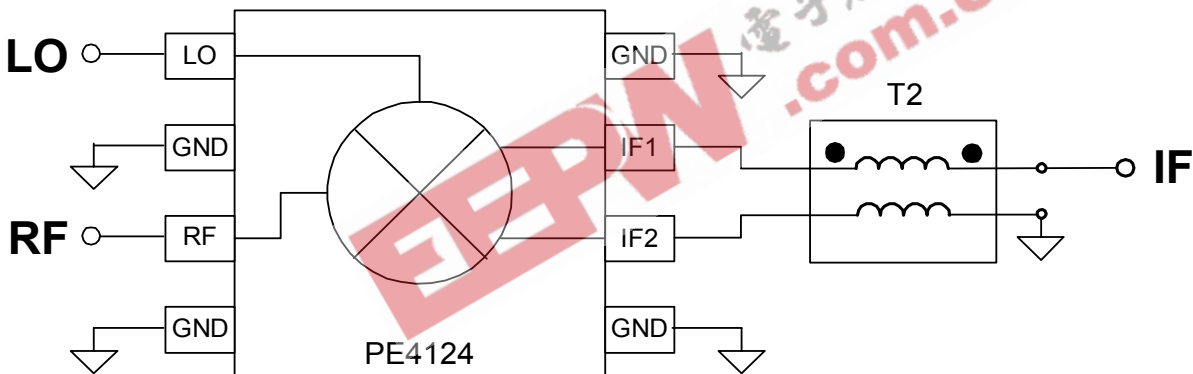

T2 M/A-Com E-Series RF 1:1 Transformer ETC1-1-13

Figure 6. Evaluation Board Testing Block Diagram, 2-Tone Setup

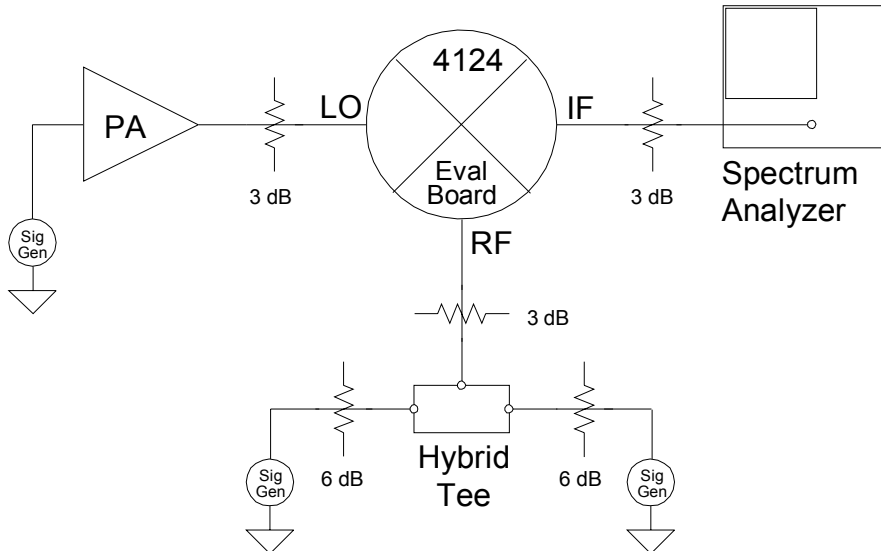

Typical Performance Plots (LO=17 dBm, RF=3 dBm, IF=70 MHz)

Figure 7. Conversion Loss vs. Frequency

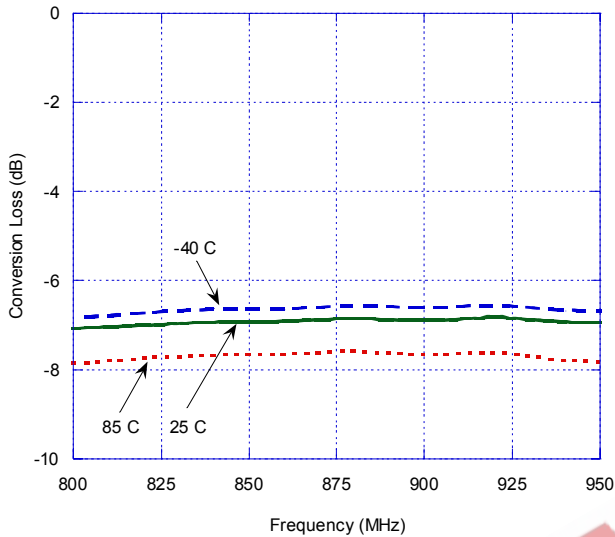

Figure 8. Input 1dB Compression vs. Frequency

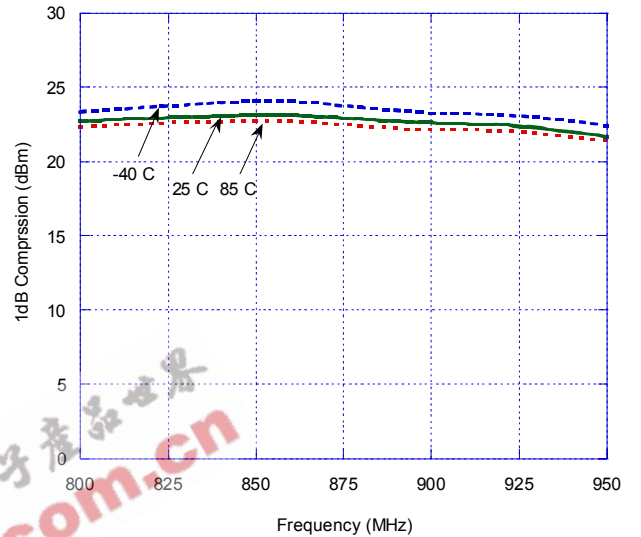

Figure 9. Input IP3 vs. Frequency

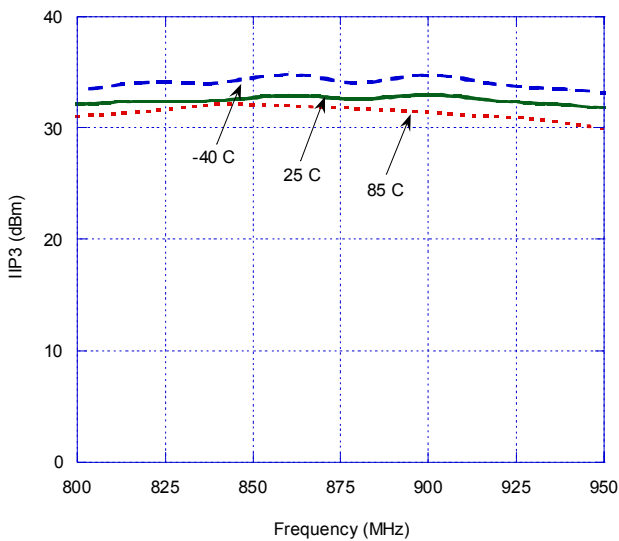
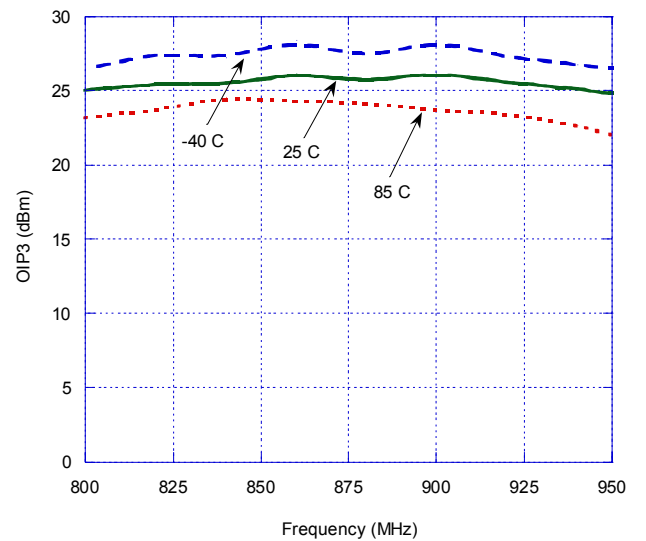

Figure 10. Output IP3 vs. Frequency



Typical Performance Plots (LO=17 dBm, RF=3 dBm, IF=70 MHz)

Figure 11. LO-RF Isolation vs. Frequency

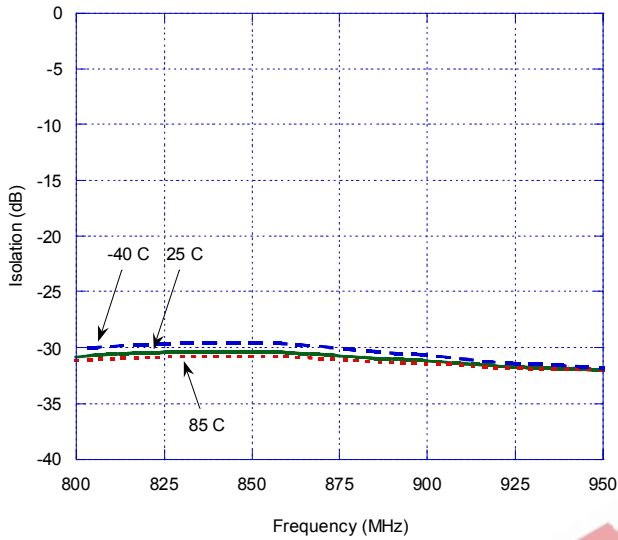

Figure 12. LO-IF Isolation vs. Frequency

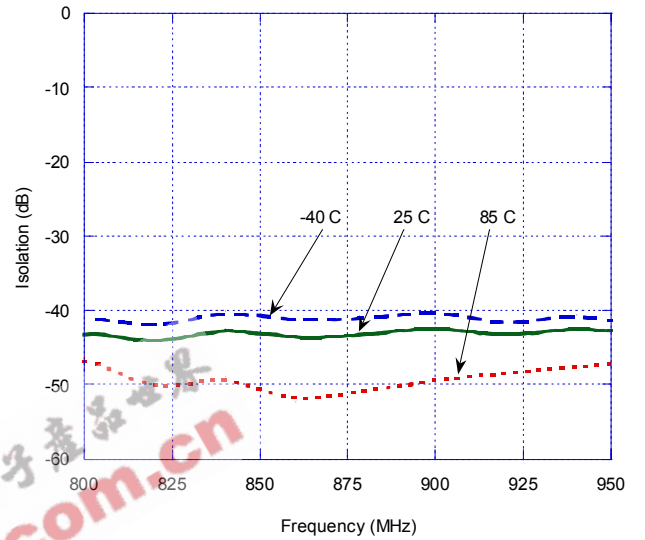

Figure 13. LO Port Return Loss vs. Frequency

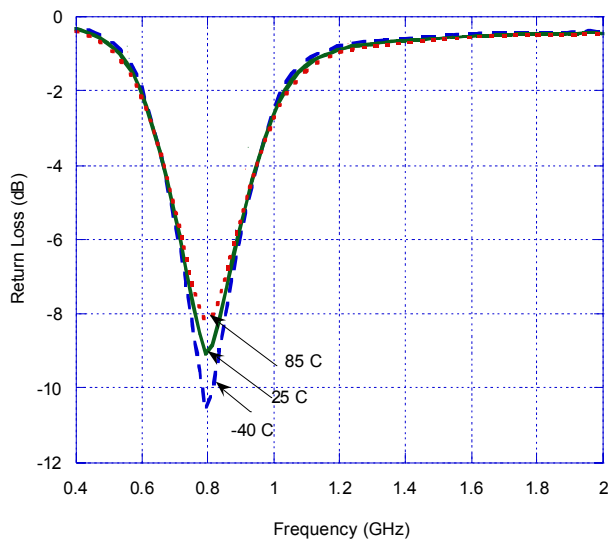
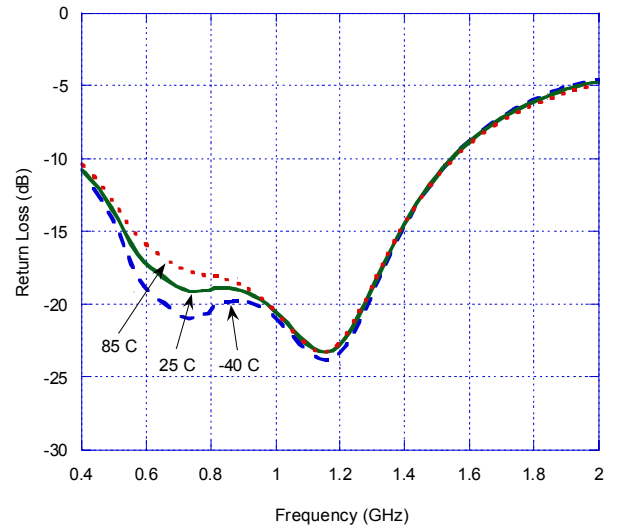

Figure 14. RF Port Return Loss vs. Frequency



Typical Performance Data @ +25 °C (RF=3 dBm, IF=70 MHz)

Figure 15. Input IP3 across LO Drive

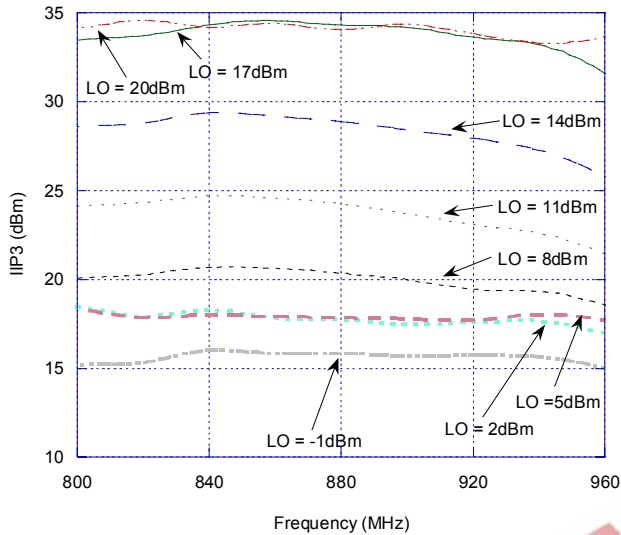

Figure 16. Conversion Loss across LO Drive

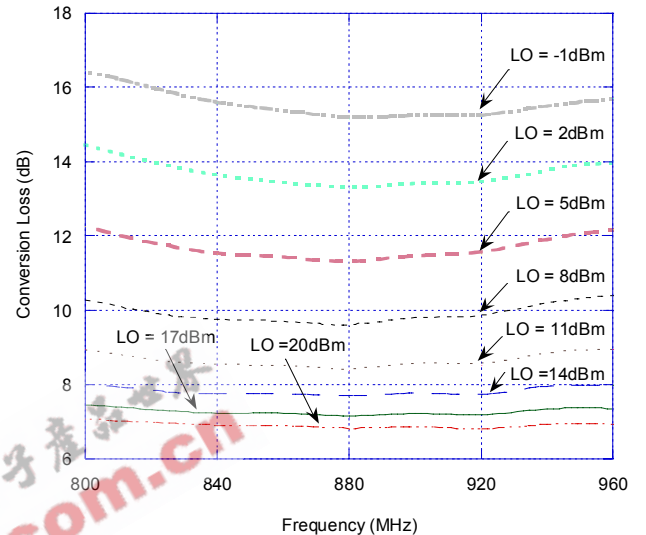

Table 5. Spurious Response

mF _{RF}	mF _{RF} + nF _{LO}				
	nF _{LO}				
	0	1	2	3	4
0	--	30	22	33	28
1	28	2	32	23	39
2	50	48	47	64	52
3	>85	65	73	63	74
4	>85	>85	>85	>85	>85

Normalized to dB below P_{1F}
(RF=870 MHz @ 3 dBm, LO = 800 MHz @ 17 dBm, low side)

Table 6. Spurious Response

mF _{RF}	mF _{RF} - nF _{LO}				
	nF _{LO}				
	0	1	2	3	4
0	--	30	22	33	28
1	28	0	29	13	39
2	50	46	52	54	48
3	>85	63	75	76	71
4	>85	>85	>85	>85	>85

Normalized to dB below P_{1F}
(RF=870 MHz @ 3 dBm, LO = 800 MHz @ 17 dBm, low side)

Figure 17. Package Drawing

8-lead TSSOP

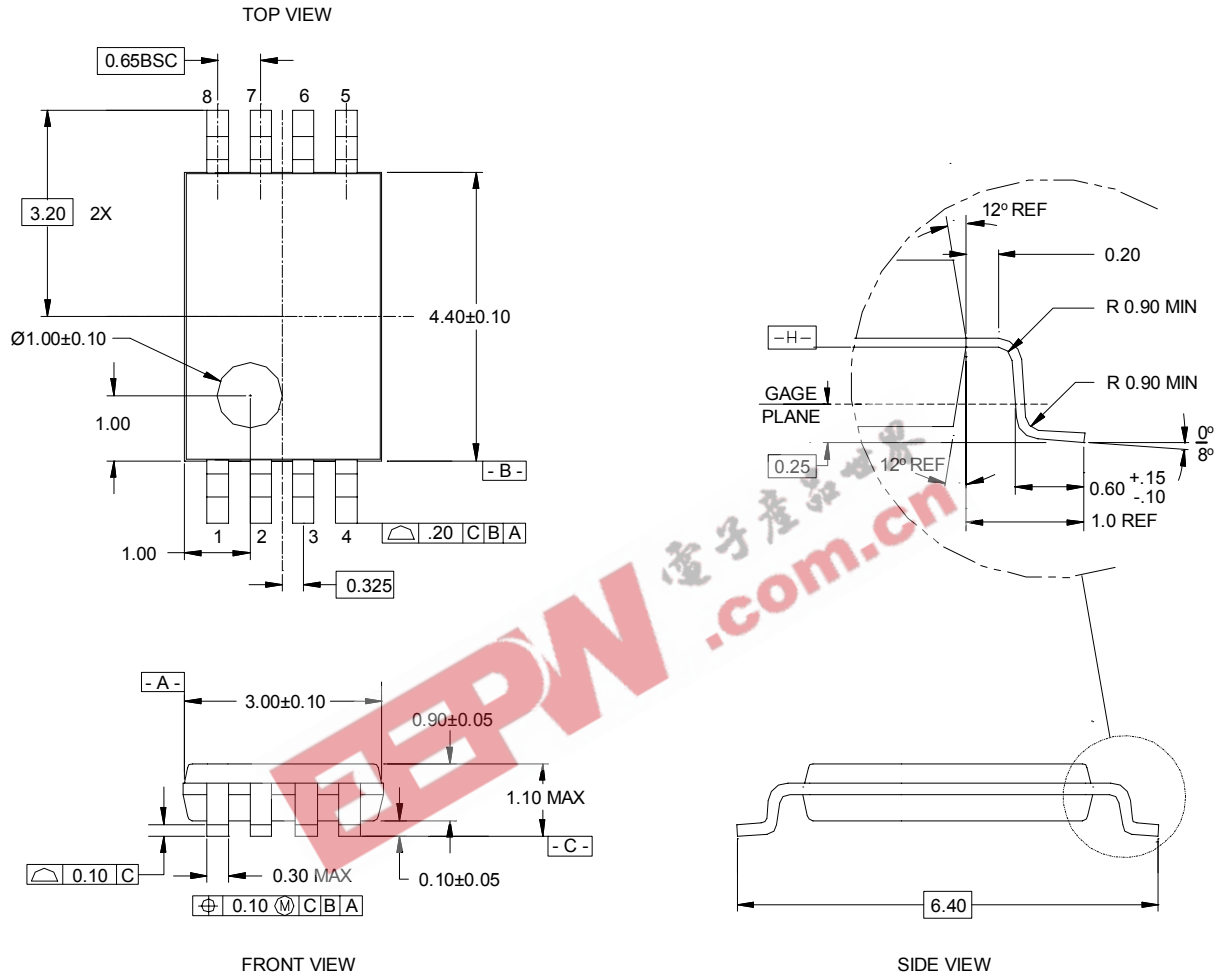

Table 7. Ordering Information

Order Code	Part Marking	Description	Package	Shipping Method
4124-21	4124	PE4124-08TSSOP-100A	8-lead TSSOP	100 units / Tube
4124-22	4124	PE4124-08TSSOP-2000C	8-lead TSSOP	2000 units / T&R
4124-00	PE4124-EK	PE4124-08TSSOP-EK	Evaluation Board	1 / Box

Sales Offices

The Americas

Peregrine Semiconductor Corporation

9450 Carroll Park Drive
San Diego, CA 92121
Tel 858-731-9400
Fax 858-731-9499

Europe

Peregrine Semiconductor Europe

Bâtiment Maine
13-15 rue des Quatre Vents
F- 92380 Garches, France
Tel: +33-1-47-41-91-73
Fax : +33-1-47-41-91-73

Space and Defense Products

Americas:

Tel: 505-881-0438
Fax: 505-881-0443

Europe, Asia Pacific:

180 Rue Jean de Guiramand
13852 Aix-En-Provence cedex 3, France
Tel: +33(0) 4 4239 3361
Fax: +33(0) 4 4239 7227

North Asia Pacific

Peregrine Semiconductor K.K.

5A-5, 5F Imperial Tower
1-1-1 Uchisaiwaicho, Chiyoda-ku
Tokyo 100-0011 Japan
Tel: +81-3-3502-5211
Fax: +81-3-3502-5213

Peregrine Semiconductor, Korea

#B-2402, Kolon Tripolis, #210
Geumgok-dong, Bundang-gu, Seongnam-si,
Gyeonggi-do, 463-480 S. Korea
Tel: +82-31-728-4300
Fax: +82-31-728-4305

South Asia Pacific

Peregrine Semiconductor, China

Shanghai, 200040, P.R. China
Tel: +86-21-5836-8276
Fax: +86-21-5836-7652

For a list of representatives in your area, please refer to our Web site at: www.psemi.com

Data Sheet Identification

Advance Information

The product is in a formative or design stage. The data sheet contains design target specifications for product development. Specifications and features may change in any manner without notice.

Preliminary Specification

The data sheet contains preliminary data. Additional data may be added at a later date. Peregrine reserves the right to change specifications at any time without notice in order to supply the best possible product.

Product Specification

The data sheet contains final data. In the event Peregrine decides to change the specifications, Peregrine will notify customers of the intended changes by issuing a DCN (Document Change Notice).

The information in this data sheet is believed to be reliable. However, Peregrine assumes no liability for the use of this information. Use shall be entirely at the user's own risk.

No patent rights or licenses to any circuits described in this data sheet are implied or granted to any third party.

Peregrine's products are not designed or intended for use in devices or systems intended for surgical implant, or in other applications intended to support or sustain life, or in any application in which the failure of the Peregrine product could create a situation in which personal injury or death might occur. Peregrine assumes no liability for damages, including consequential or incidental damages, arising out of the use of its products in such applications.

The Peregrine name, logo, and UTSi are registered trademarks and UltraCMOS and HaRP are trademarks of Peregrine Semiconductor Corp.