





6 5 4 3 2 1

MATERIAL AND FINISH

Insulator: Polycarbonate, UL-94V-0 rated
 Contacts: Brass, Nickel plated

ELECTRICAL SPECIFICATIONS:

Current rating: 10 A 
 Voltage rating: 250 VAC 
 Current rating: 15 A 
 Voltage rating: 250 VAC 

ORDERING CODE:

42R02-1 1 2 3



1 = TERMINAL OPTIONS

- 1 = .187(4.8)
- 2 = .250(6.3)

2 = COLOR

- 1 = BLACK
- 2 = GRAY

3 = ELECTRICAL CIRCUIT CONFIGURATION

- 1 = 15A 250V 120°C 
- 2 = 15A 250V 70°C 
- 4 = 15A 250V 70°C 

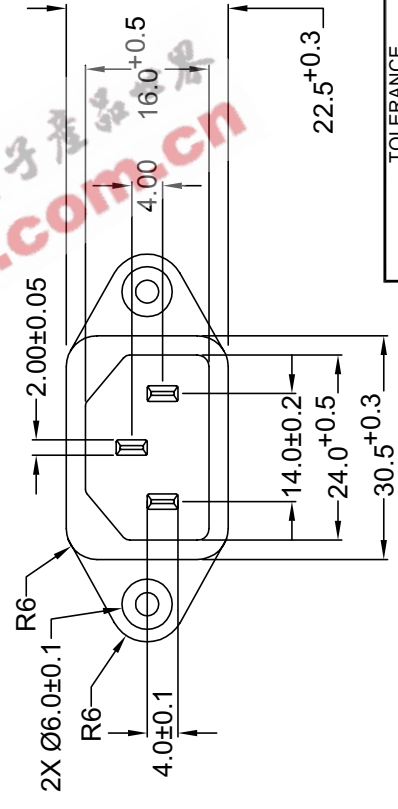
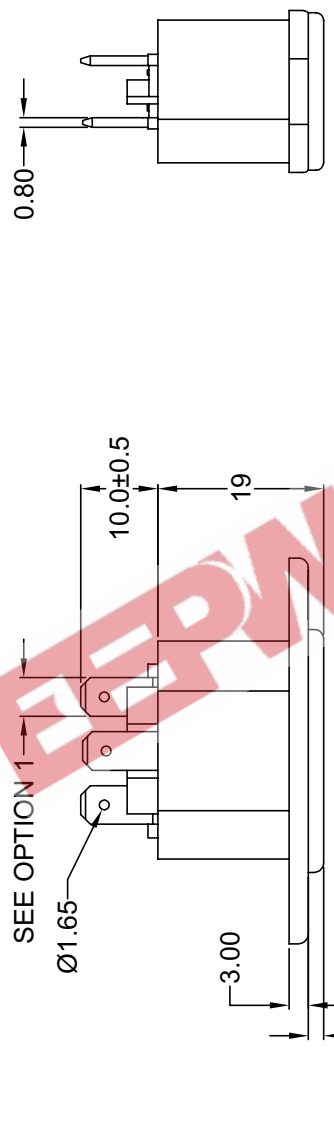
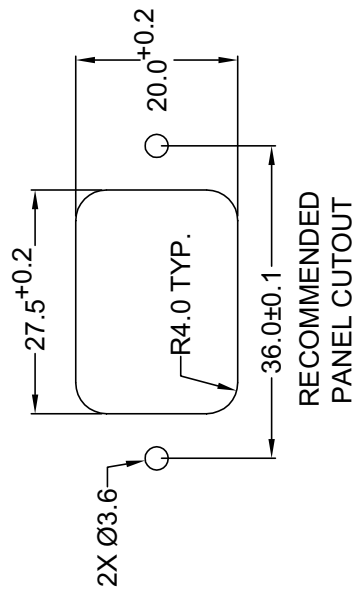
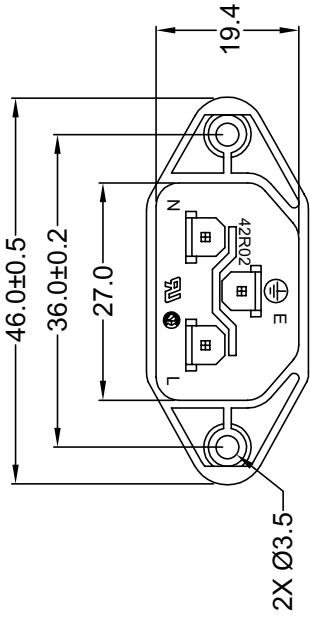

REVISIONS	CHNG	CHK	APPR

TOLERANCE
 UNLESS OTHERWISE SPECIFIED
 X ± 1
 X.X ± 0.4
 X.XX ± 0.20

Power Dynamics, Inc.
 Phone: 973 560-0019 Whippany, New Jersey Fax: 973 560-0076
 PART: IEC 60320 C-14 APPL. INLET; QUICK CONNECT
 TERMINALS; SIDE FLANGED, PANEL MOUNT

DRAWN BY	GQ	DATE:	8/3/01
CHECK BY	TD	DATE:	8/13/01
APPR BY	PB	DATE:	8/13/01

PART #: 42R02-1XXX
 SHEET 1 of 1
 SCALE: NTS
 ALL DIMENSIONS FOR REFERENCE ONLY
 DIMENSIONS ARE IN MILLIMETERS

6 5 4 3 2 1

MATERIAL AND FINISH

Insulator: Polycarbonate, UL-94V-0 rated
 Contacts: Brass, Nickel plated

ELECTRICAL SPECIFICATIONS:

Current rating: 10 A
 Voltage rating: 250 VAC
 Current rating: 15 A
 Voltage rating: 250 VAC

ORDERING CODE:

42R02-2 1 2 3

1 = TERMINAL OPTIONS

- 1 = .187(4.8)
- 2 = .250(6.3)

2 = COLOR

- 1 = BLACK
- 2 = GRAY

3 = ELECTRICAL CIRCUIT CONFIGURATION

- 1 = 15A 250V 120°C
2+GROUND
- 2 = 15A 250V 70°C
2+GROUND
- 4 = 15A 250V 70°C
2 POLE

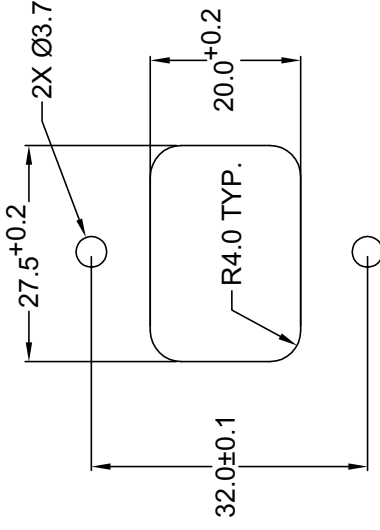

RECOMMENDED
 PANEL CUTOUT

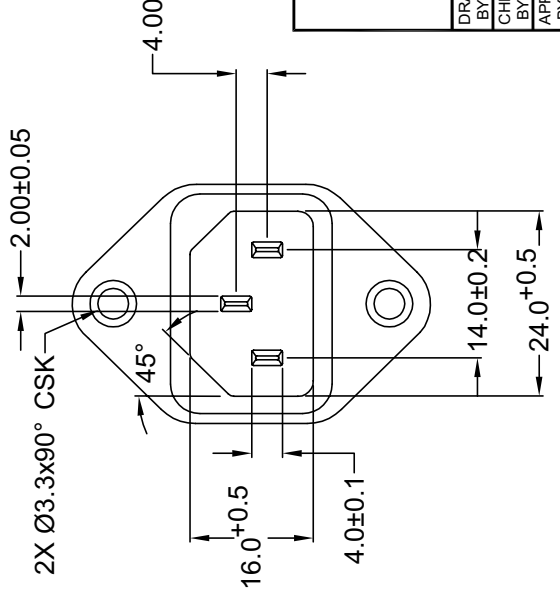
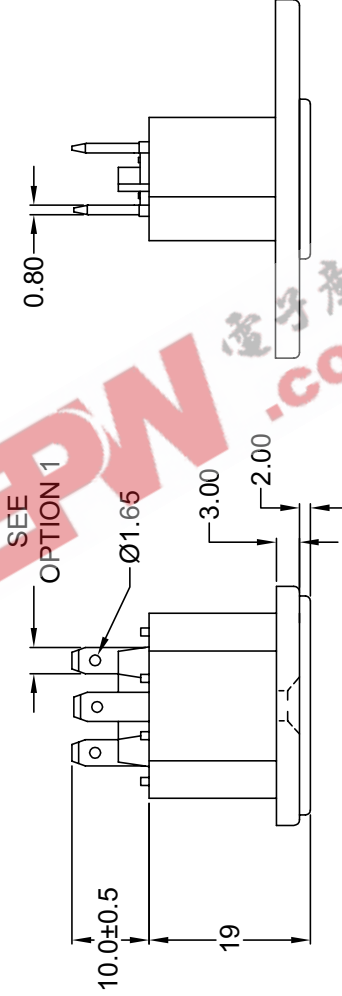
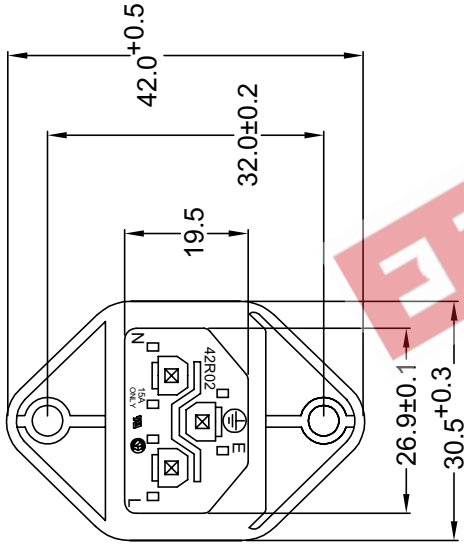

REV	DATE	CHANGE	CHNG	CHK	APP

REVISIONS

TOLERANCE
 UNLESS OTHERWISE SPECIFIED

X ± 1
 X.X ± 0.4
 X.XX ± 0.20

DRAWN BY	GQ	DATE:	8/3/01
CHECK BY	TD	DATE:	8/13/01
APPR BY	PB	DATE:	8/13/01

Power Dynamics, Inc.
 Phone: 973 560-0019 Whippary, New Jersey Fax: 973 560-0076
 PART: IEC 60320 C-14 APPL. INLET; QUICK CONNECT
 TERMINALS; CROSS FLANGE

PART #
42R02-2XXX

SHEET
 1 of 1

SCALE: NTS
 ALL DIMENSIONS FOR REFERENCE ONLY
 DIMENSIONS ARE IN MILLIMETERS

MATERIAL AND FINISH

Insulator: Polycarbonate, UL-94V-0 rated
 Contacts: Brass, Nickel plated

ELECTRICAL SPECIFICATIONS:

Current rating: 10 A
 Voltage rating: 250 VAC
 Current rating: 15 A
 Voltage rating: 250 VAC

ORDERING CODE:

42R02-3 _ _ _ _ _
 1 2 3 4

1 = TERMINAL OPTIONS

- 1 = .187(4.8)
- 2 = .250(6.3)

2 = COLOR

- 1 = BLACK
- 2 = GRAY

3 = ELECTRICAL CIRCUIT CONFIGURATION

- 1 = 15A 250V 120°C
 2+GROUND



- 2 = 15A 250V 70°C
 2+GROUND



- 4 = 15A 250V 70°C
 2 POLE



4 = PANEL THICKNESS

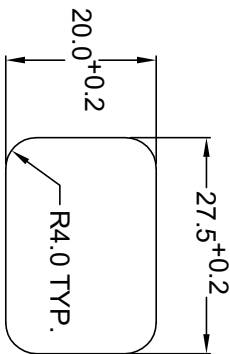
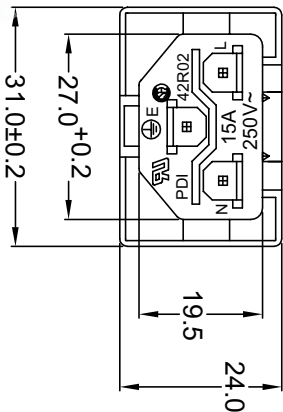

RECOMMENDED
 PANEL CUTOUT

SEE OPTION 1

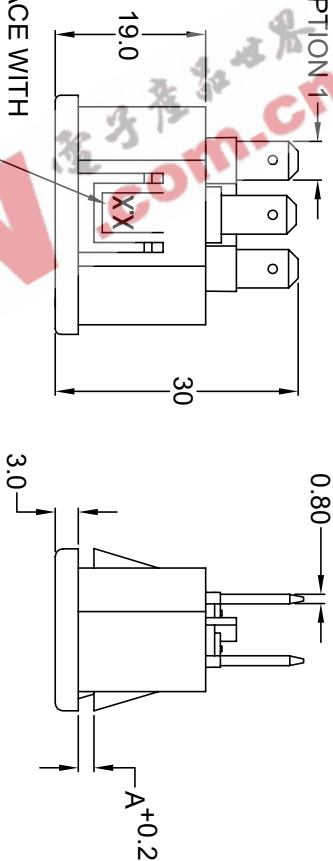

REPLACE WITH
 CORRESPONDING
 PANEL THICKNESS

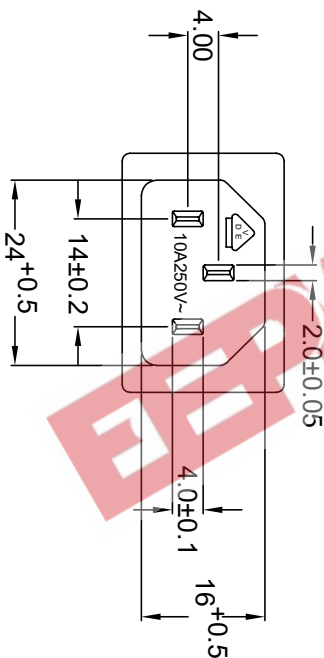

P/N	A	MAX. PANEL THICKNESS
42R02-3XXX-150	1.5	1.5
42R02-3XXX-200	2.0	2.0
42R02-3XXX-250	2.5	2.5

ADDITIONAL PANEL THICKNESS
 AVAILABLE ON REQUEST

Power Dynamics, Inc.

Phone: 973 560-0019 Whippany, New Jersey Fax: 973 560-0076

PART: IEC 60320 CONNECTOR; QUICK
 CONNECT INLET; SNAP-IN

PART #: 42R02-3XXX-XXX

DRAWN BY	GQ	DATE:	8/2/01
CHECK BY	TD	DATE:	08/14/01
APPR BY	PB	DATE:	08/14/01

TOLERANCE
 UNLESS OTHERWISE SPECIFIED

X ± 1
 XX ± 0.4
 XXX ± 0.20

SCALE: NTS

ALL DIMENSIONS FOR REFERENCE ONLY
 DIMENSIONS ARE IN MILLIMETERS

SHEET 1 of 1
 REV:



REVISIONS

REV	DATE	CHANGE	CHNG	CHK	APPR

MATERIAL AND FINISH

Insulator: Polycarbonate, UL-94V-0 rated
 Contacts: Brass, Nickel plated

ELECTRICAL SPECIFICATIONS:

Current rating: 10 A 
 Voltage rating: 250 VAC
 Current rating: 15 A 
 Voltage rating: 250 VAC 

ORDERING CODE:
 42R02-4 1 2 3



1 = TERMINAL OPTIONS

- 1 = .187(4.8)
- 2 = .250(6.3)

2 = COLOR

- 1 = BLACK
- 2 = GRAY

3 = ELECTRICAL CIRCUIT CONFIGURATION

- 1 = 15A 250V 120°C 
- 2+GROUND
- 2 = 15A 250V 70°C 
- 2+GROUND
- 4 = 15A 250V 70°C 
- 2 POLE

REV	DATE	CHANGE	CHNG	CHK	CHK	APPR

REVISIONS

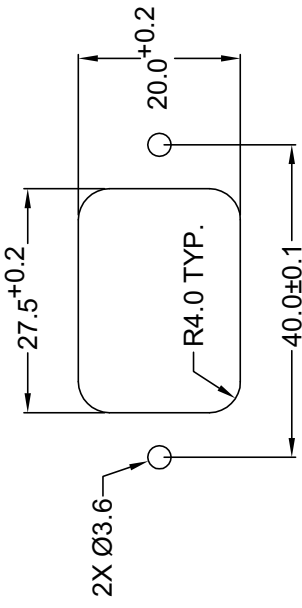
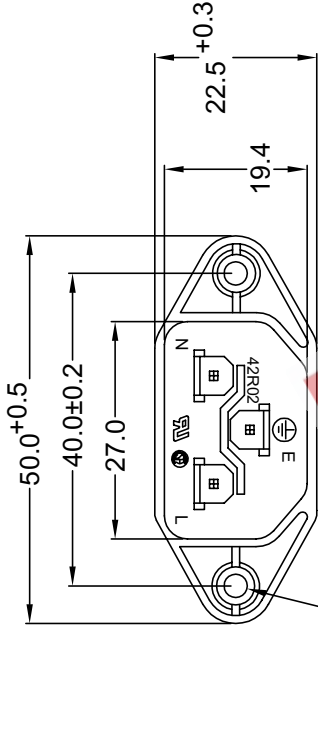

RECOMMENDED
 PANEL CUT-OUT

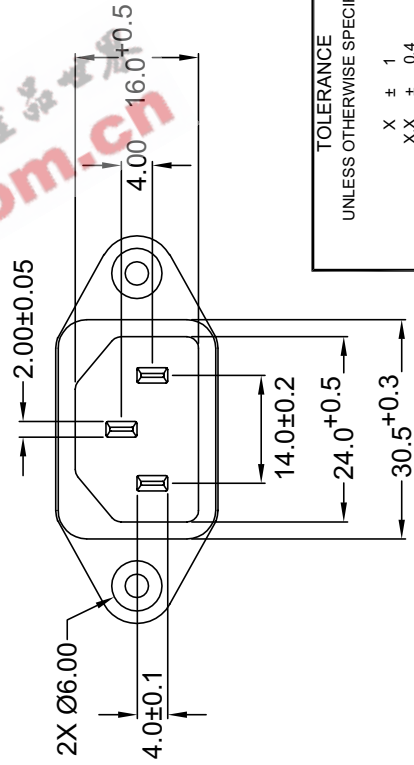
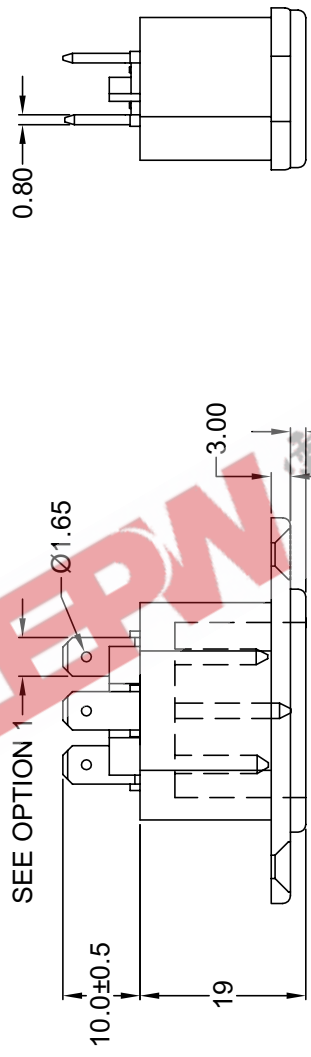

TOLERANCE
 UNLESS OTHERWISE SPECIFIED

X ± 1
 X.X ± 0.4
 X.XX ± 0.20

Power Dynamics, Inc.
 Phone: 973 560-0019 Whippany, New Jersey Fax: 973 560-0076
 PART: IEC 60320 C-14 APPL. INLET; QUICK CONNECT
 TERMINALS; SIDE FLANGE, PANEL MOUNT

DRAWN BY	GQ	DATE:	8/6/01
CHECK BY	TD	DATE:	8/13/01
APPR BY	PB	DATE:	8/13/01

PART # **42R02-4XXX**

SIZE: A
 SCALE: NTS

SHEET 1 of 1
 ALL DIMENSIONS FOR REFERENCE ONLY
 DIMENSIONS ARE IN MILLIMETERS
 REV:

6 5 4 3 2 1

MATERIAL AND FINISH

Insulator: Polycarbonate, UL-94V-0 rated
 Contacts: Brass, Nickel plated

ELECTRICAL SPECIFICATIONS:

Current rating: 10 A 
 Voltage rating: 250 VAC
 Current rating: 15 A 
 Voltage rating: 250 VAC

ORDERING CODE:

42R02-5 1 2 3



1 = TERMINAL OPTIONS

- 1 = .187(4.8)
- 2 = .250(6.3)

2 = COLOR

- 1 = BLACK
- 2 = GRAY

3 = ELECTRICAL CIRCUIT CONFIGURATION

- 1 = 15A 250V 120°C 
- 2 = 15A 250V 70°C 
- 4 = 15A 250V 70°C 

REV	DATE	CHNG	CHK	APPR
REVISIONS				

0.80

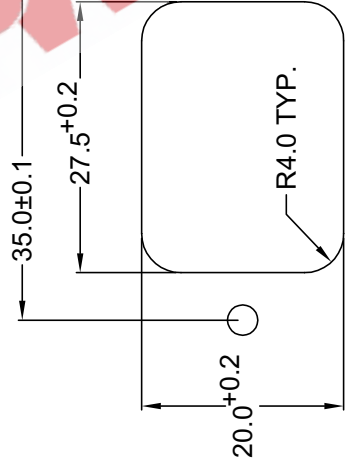
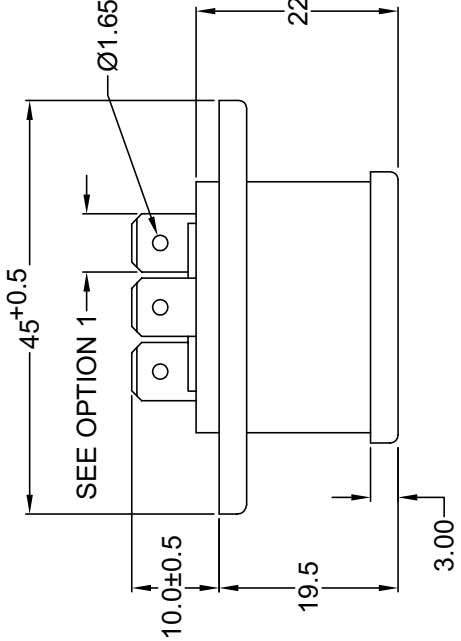
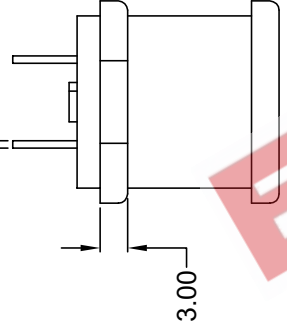

RECOMMENDED
 PANEL CUTOUT

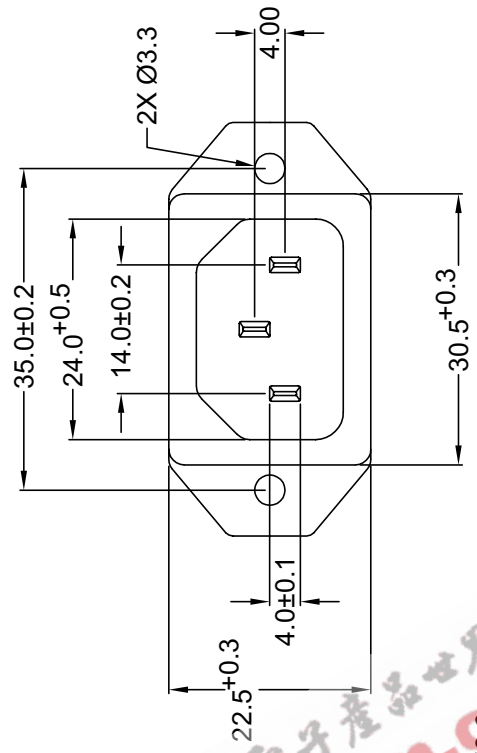

Power Dynamics, Inc.

Phone: 973 560-0019 Whippary, New Jersey Fax: 973 560-0076

PART: IEC 60320 C14 APPL. INLET; QUICK CONNECT
 TERMINALS; BOTTOM FLANGE

PART #	42R02-5XXX	SHEET	1 of 1
SIZE	A	ALL DIMENSIONS FOR REFERENCE ONLY	REV.
SCALE	NTS	DIMENSIONS ARE IN MILLIMETERS	

TOLERANCE
 UNLESS OTHERWISE SPECIFIED

X ± 1
 X.X ± 0.4
 X.XX ± 0.20

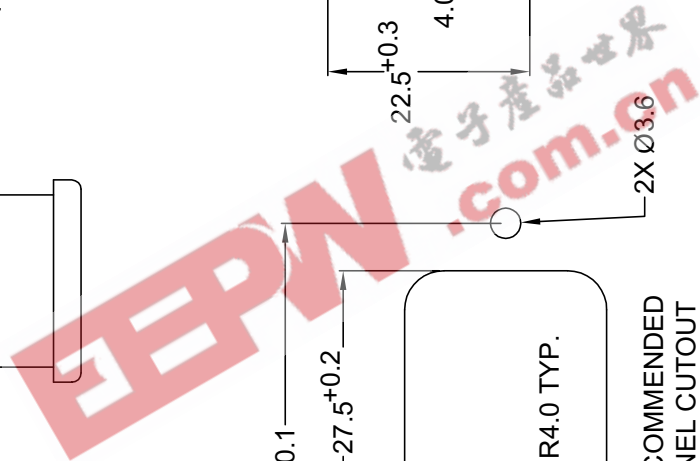

DRAWN BY	GQ	DATE	8/9/01
CHECK BY	TD	DATE	8/13/01
APPR BY	PB	DATE	8/13/01



MATERIAL AND FINISH

Insulator: Polycarbonate, UL-94V-0 rated
 Contacts: Brass, Nickel plated

ELECTRICAL SPECIFICATIONS:

Current rating: 10 A 
 Voltage rating: 250 VAC
 Current rating: 15 A 
 Voltage rating: 250 VAC 

ORDERING CODE:

42R02-6 1 2 3







1 = TERMINAL OPTIONS

- 1 = .187(4.8)
- 2 = .250(6.3)

2 = COLOR

- 1 = BLACK
- 2 = GRAY

3 = ELECTRICAL CIRCUIT CONFIGURATION

- 1 = 15A 250V 120°C 
- 2+GROUND 
- 2 = 15A 250V 70°C 
- 2+GROUND 
- 4 = 15A 250V 70°C 
- 2 POLE 

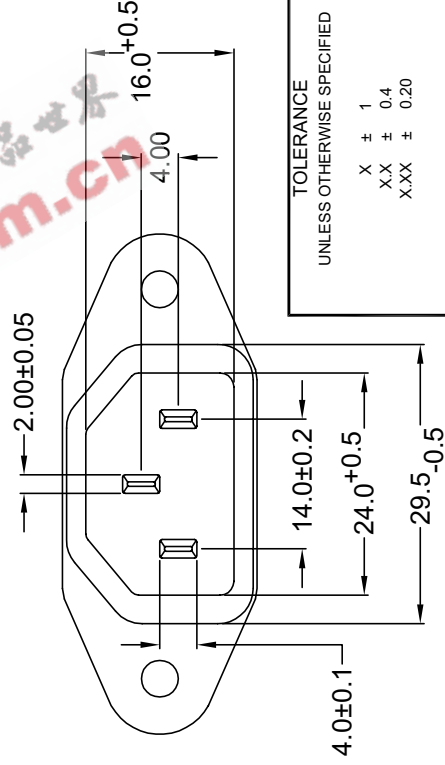
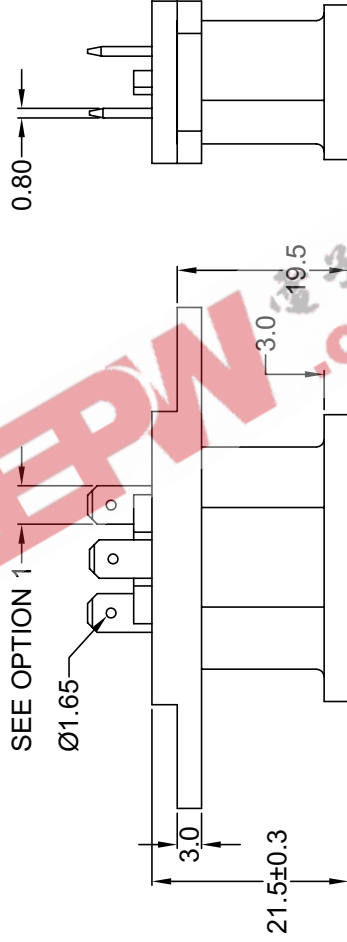
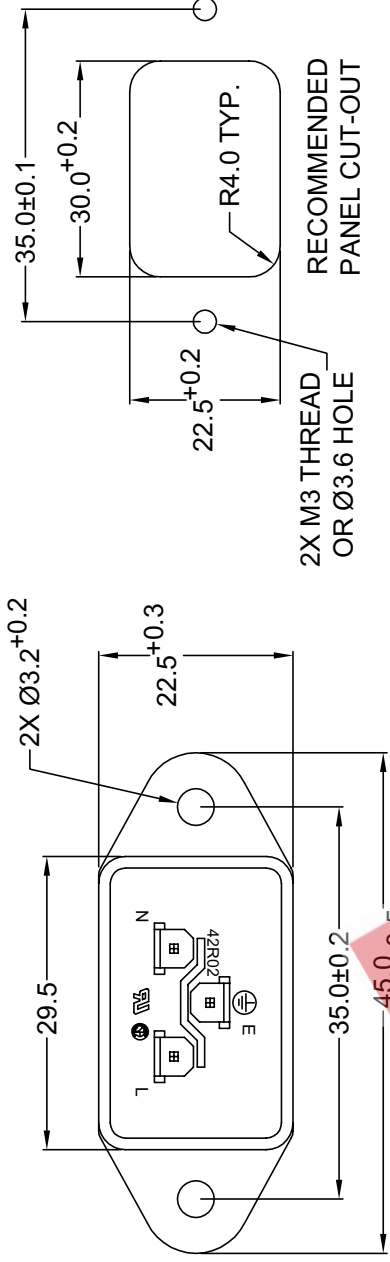

REV	DATE	CHANGE	CHNG	CHK	APP

REVISIONS

DRAWN BY	GQ	DATE:	8/6/01
CHECK BY	TD	DATE:	8/13/01
APPR BY	PB	DATE:	8/13/01

TOLERANCE
 UNLESS OTHERWISE SPECIFIED
 X ± 1
 X.X ± 0.4
 X.XX ± 0.20

Power Dynamics, Inc.
 Phone: 973 560-0019 Whippany, New Jersey Fax: 973 560-0076
 PART: IEC 60320 C-14 APPL. INLET; QUICK CONNECT
 TERMINALS; BOTTOM FLANGE

PART #	42R02-6XXX
SIZE	A
SCALE	NTS





SHEET 1 of 1
 ALL DIMENSIONS FOR REFERENCE ONLY
 DIMENSIONS ARE IN MILLIMETERS
 REV.

6 5 4 3 2 1

MATERIAL AND FINISH

Insulator: Polycarbonate, UL-94V-0 rated
 Contacts: Brass, Nickel plated

ELECTRICAL SPECIFICATIONS:

Current rating: 10 A 
 Voltage rating: 250 VAC 
 Current rating: 15 A 
 Voltage rating: 250 VAC 

ORDERING CODE:

42R02-7 1 2 3



1 = TERMINAL OPTIONS

- 1 = .187(4.8)
- 2 = .250(6.3)

2 = COLOR

- 1 = BLACK
- 2 = GRAY

3 = ELECTRICAL CIRCUIT CONFIGURATION

- 1 = 15A 250V 120°C 
2+GROUND
- 2 = 15A 250V 70°C 
2+GROUND
- 4 = 15A 250V 70°C 
2 POLE

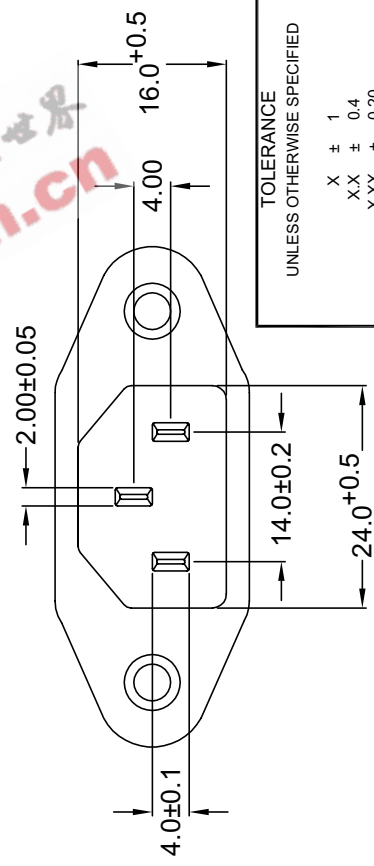
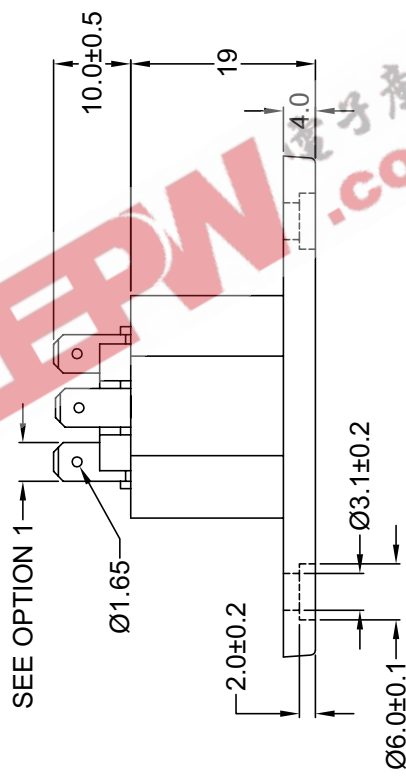
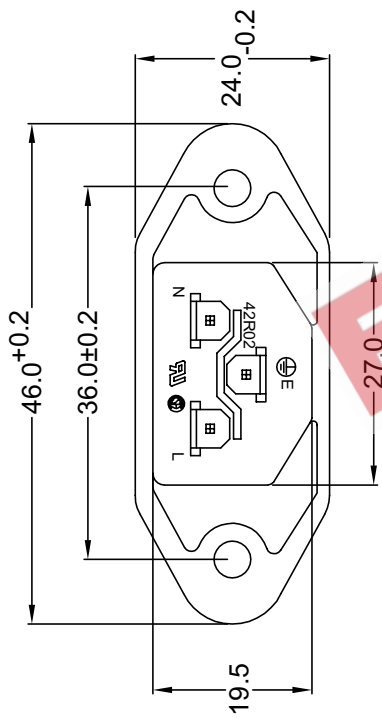
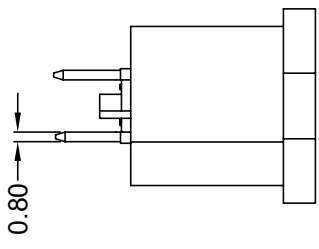
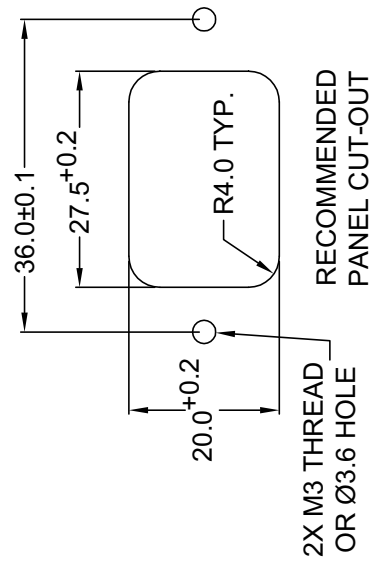

TOLERANCE
 UNLESS OTHERWISE SPECIFIED

X ± 1
 X.X ± 0.4
 X.XX ± 0.20

Power Dynamics, Inc.
 Phone: 973 560-0019 Whippany, New Jersey Fax: 973 560-0076
 PART: IEC 60320 C-14 APPL. INLET; QUICK CONNECT
 TERMINALS; SIDE FLANGE

PART #		42R02-7XXX	
SIZE:	A	ALL DIMENSIONS FOR REFERENCE ONLY DIMENSIONS ARE IN MILLIMETERS	
SCALE:	NTS	REV.	

DRAWN BY	GQ	DATE:	08/07/01
CHECK BY	TD	DATE:	8/14/01
APPR BY	PB	DATE:	8/14/01

REV	DATE	CHANGE	CHNG	CHK	APP
-----	------	--------	------	-----	-----





REVISIONS

SHEET 1 of 1

MATERIAL AND FINISH

Insulator: Polycarbonate, UL-94V-0 rated
 Contacts: Brass, Nickel plated

ELECTRICAL SPECIFICATIONS:

Current rating: 10 A 
 Voltage rating: 250 VAC 
 Current rating: 15 A 
 Voltage rating: 250 VAC 

ORDERING CODE:

42R02-1 1 2 3



1 = TERMINAL OPTIONS

- 1 = .187(4.8)
- 2 = .250(6.3)

2 = COLOR

- 1 = BLACK
- 2 = GRAY

3 = ELECTRICAL CIRCUIT CONFIGURATION

- 1 = 15A 250V 120°C  2+GROUND
- 2 = 15A 250V 70°C  2+GROUND
- 4 = 15A 250V 70°C  2 POLE

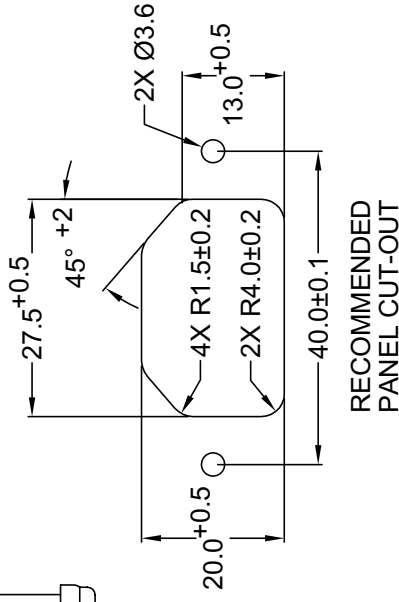
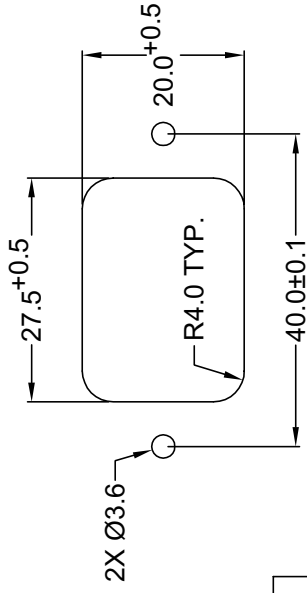
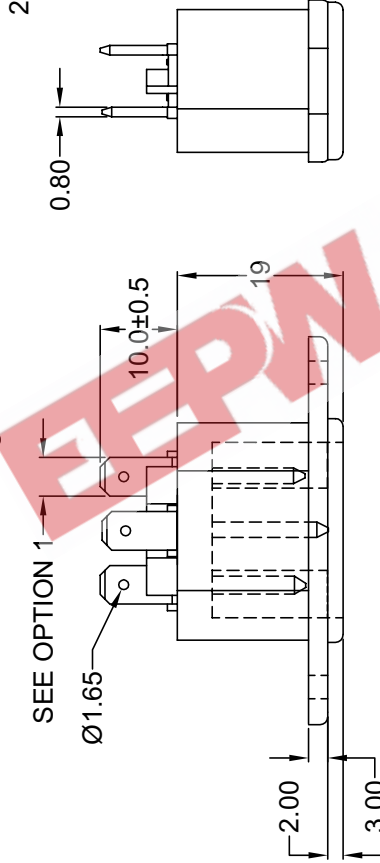
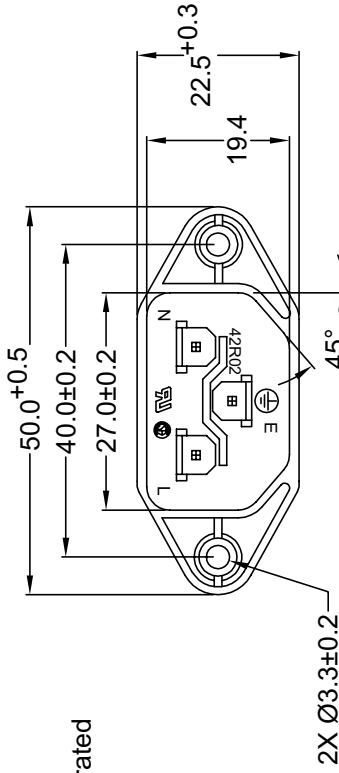

RECOMMENDED
 PANEL CUT-OUT

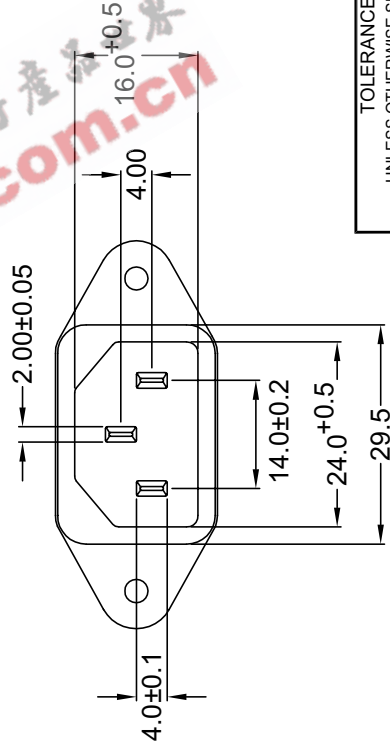

REV	DATE	CHANGE	CHNG	CHK	APP

REVISIONS

DRAWN BY	GQ	DATE	8/7/01
CHECK BY	TD	DATE	8/13/01
APPR BY	PB	DATE	8/13/01

TOLERANCE
 UNLESS OTHERWISE SPECIFIED
 X ± 1
 X.X ± 0.4
 X.XX ± 0.20

Power Dynamics, Inc.
 Phone: 973 560-0019 Whippany, New Jersey Fax: 973 560-0076
 PART: IEC 60320 C14 APPL. INLET; QUICK CONNECT
 TERMINALS; SIDE FLANGE

PART #	42R02-8XXX
SIZE	A
SCALE	NTS

ALL DIMENSIONS FOR REFERENCE ONLY
 DIMENSIONS ARE IN MILLIMETERS

SHEET	1 of 1
REV.	