

HIGH FREQUENCY SWITCHING  
TRANSISTORS FOR BALLASTERS

## DESCRIPTION

UTC 4124 is designed for specially used for electronic ballasters in 110VAC environment.

## FEATURES

- \* Triple diffused technology.
- \* High switching speed

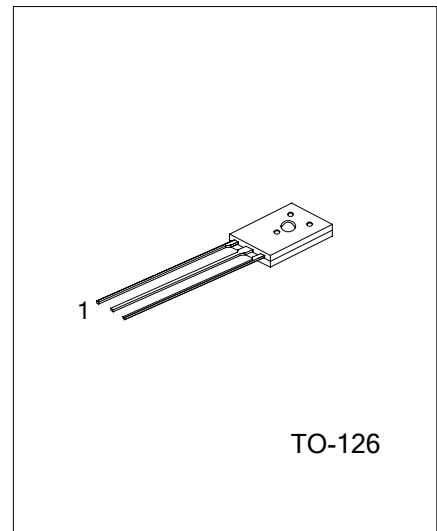

TO-126

1: BASE 2: COLLECTOR 3: EMITTER  
\*Pb-free plating product number:4124L

## ABSOLUTE MAXIMUM RATINGS

(T<sub>c</sub> = 25°C)

PARAMETER	SYMBOL	RATINGS	UNIT
Collector-Base Voltage	V <sub>CBO</sub>	400	V
Collector-Emitter Voltage	V <sub>CEO</sub>	200	V
Collector-Emitter Voltage	V <sub>EBO</sub>	7	V
Peak Collector Current	I <sub>C</sub>	1.5	A
Peak Collector Consume Dissipation	P <sub>C</sub>	20	W
Peak Junction Temperature	T <sub>J</sub>	150	°C
Storage Temperature	T <sub>STG</sub>	-40 ~ +150	°C

## ELECTRICAL CHARACTERISTICS

(T<sub>a</sub> = 25°C)

PARAMETER	SYMBOL	TEST CONDITIONS	MIN	TYP	MAX	UNIT
Collector-Emitter Sustaining Voltage	V <sub>CEO (SUS)</sub>	I <sub>C</sub> =10mA, I <sub>B</sub> =0	200			V
Collector-Base Breakdown Voltage	V <sub>(BR) CBO</sub>	I <sub>C</sub> =1mA, I <sub>B</sub> =0	400			V
Emitter-Base Breakdown Voltage	V <sub>(BR) EBO</sub>	I <sub>E</sub> =1mA, I <sub>C</sub> =0	7			V
Collector-Base Cutoff Current	I <sub>CBO</sub>	V <sub>CB</sub> =400V, I <sub>E</sub> =0			100	μA
Collector-Emitter Cutoff Current	I <sub>CEO</sub>	V <sub>CE</sub> =200V, I <sub>B</sub> =0			100	μA
Emitter-Base Cutoff Current	I <sub>EBO</sub>	V <sub>EB</sub> =7V, I <sub>C</sub> =0			100	μA
DC Current Gain	h <sub>FE (1)</sub>	V <sub>CE</sub> =10V, I <sub>C</sub> =0.2A	10		60	
	h <sub>FE (2)</sub>	V <sub>CE</sub> =5V, I <sub>C</sub> =1.5A	5		40	
Collector-Emitter Saturation Voltage	V <sub>CE (sat)</sub>	I <sub>C</sub> =0.4A, I <sub>B</sub> =0.1A			0.5	V
		I <sub>C</sub> =1.5A, I <sub>B</sub> =0.5A			2	V
Base-Emitter Saturation Voltage	V <sub>BE (sat)</sub>	I <sub>C</sub> =0.8A, I <sub>B</sub> =0.2A			1.2	V
Fall Time	t <sub>f</sub>	I <sub>C</sub> =1A, I <sub>B1</sub> = -I <sub>B2</sub> = 0.2A			0.7	μs
Storage Time	t <sub>s</sub>	I <sub>C</sub> =1A, I <sub>B1</sub> = -I <sub>B2</sub> = 0.2A			4	μs
Cut-off Frequency	f <sub>T</sub>	V <sub>CE</sub> =10V, I <sub>C</sub> =0.1A	4			MHz

CHARACTERISTICS CURVES

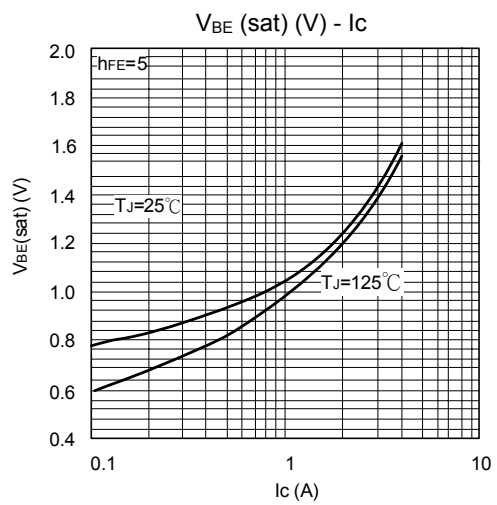
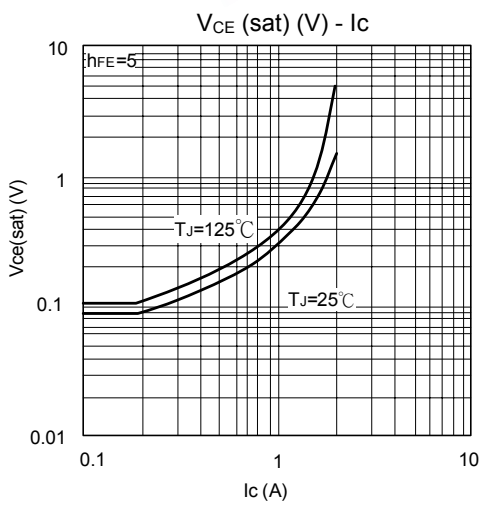
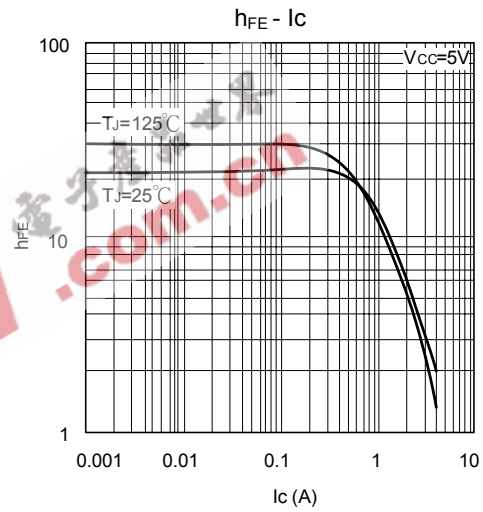
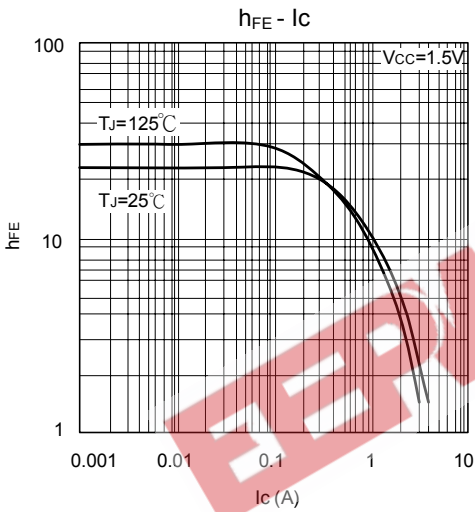
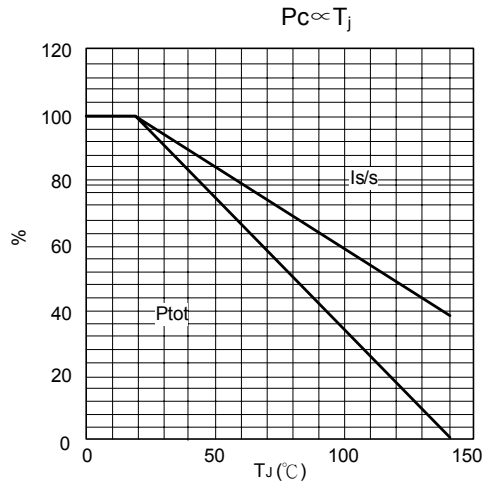
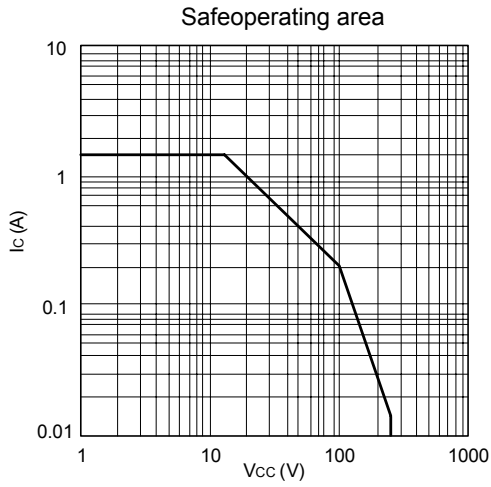

EEPW 电子產品世界  
.com.cn

UTC assumes no responsibility for equipment failures that result from using products at values that exceed, even momentarily, rated values (such as maximum ratings, operating condition ranges, or other parameters) listed in products specifications of any and all UTC products described or contained herein. UTC products are not designed for use in life support appliances, devices or systems where malfunction of these products can be reasonably expected to result in personal injury. Reproduction in whole or in part is prohibited without the prior written consent of the copyright owner. The information presented in this document does not form part of any quotation or contract, is believed to be accurate and reliable and may be changed without notice.