

FEATURES

Single +5 V Supply
On-Chip $\pi/4$ DQPSK Modulator
Modulator Bypass Analog Mode
Root-Raised Cosine Tx Filters, $\alpha = 0.35$
Two 10-Bit D/A Converters
4th Order Reconstruction Filters
Differential Analog Outputs
On-Chip Ramp Up/Down Power Control
On-Chip Tx Offset Calibration
Dual Mode Operation, Analog and Digital
Very Low Power Dissipation, 30 mW typical
Power Down Mode < 10 μ A
On-Chip Voltage Reference
24-Pin SSOP

APPLICATIONS

American Digital Cellular Telephony
American Analog Cellular Telephony

GENERAL DESCRIPTION

The AD7011 is a complete low power, CMOS, $\pi/4$ DQPSK modulator with single +5 V power supply. The part is designed to perform the baseband conversion of I and Q transmit waveforms in accordance with the American Digital Cellular Telephone system (TIA IS-54).

The on-chip $\pi/4$ Differential Quadrature Phase Shift Keying (DQPSK) digital modulator, which includes the root raised cosine filters, generates I and Q data in response to the transmit data stream. The AD7011 also contains ramp control envelope logic to shape the I and Q output waveforms when ramping up or down at the beginning or end of a transmit burst.

Besides providing all the necessary logic to perform $\pi/4$ DQPSK modulation, the part also provides reconstruction filters to smooth the DAC outputs, providing continuous time analog outputs. The AD7011 generates differential analog outputs for both the I and Q signals.

As it is a necessity for all digital mobile systems to use the lowest possible power, the device has transmit and receive power-down options. The AD7011 is housed in a space efficient 24-pin SSOP (Shrink Small Outline Package).

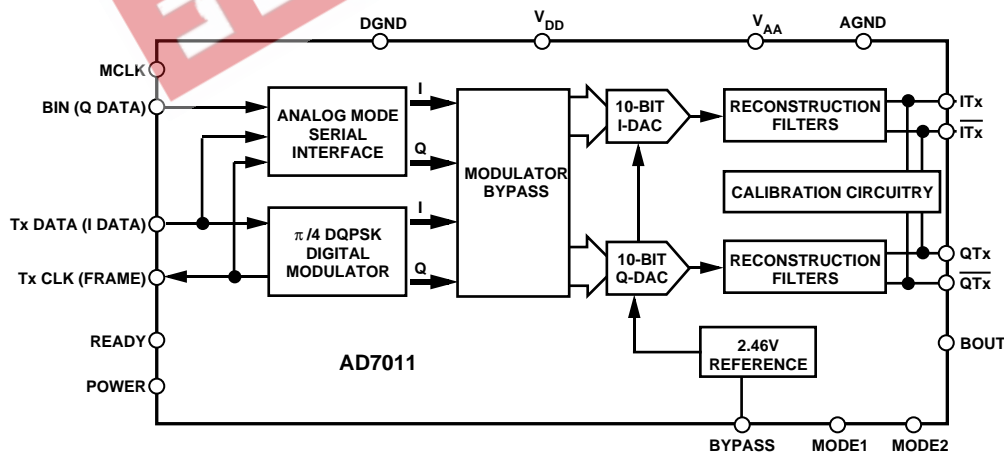
FUNCTIONAL BLOCK DIAGRAM

REV. B

Information furnished by Analog Devices is believed to be accurate and reliable. However, no responsibility is assumed by Analog Devices for its use, nor for any infringements of patents or other rights of third parties which may result from its use. No license is granted by implication or otherwise under any patent or patent rights of Analog Devices.

AD7011–SPECIFICATIONS¹

($V_{AA} = V_{DD} = +5\text{ V} \pm 10\%$; Test = AGND = DGND = 0 V; Digital Mode, $f_{MCLK} = 3.1104\text{ MHz}$; Analog Mode, $f_{MCLK} = 2.56\text{ MHz}$, POWER = V_{DD} . All specifications are T_{MIN} to T_{MAX} unless otherwise noted.)

Parameter	AD7011ARS	Units	Test Conditions/Comments
DIGITAL MODE TRANSMIT SPECIFICATIONS			
Number of Channels	2		(ITx - \overline{ITx}) and (QTx - \overline{QTx}) For Each Analog Output I Channel = (ITx - \overline{ITx}) and Q Channel = (QTx - \overline{QTx}) Measured Differentially
Output Signal Range	$V_{REF} + V_{REF}/4$	Volts	
Differential Output Range	$+V_{REF}/2$	Volts	
Signal Vector Magnitude ²	$0.875 \pm 7.5\%$	Volts max	
Error Vector Magnitude ²	1	% rms typ	
	2.5	% rms max	
Offset Vector Magnitude ²	0.5	% typ	
	2.5	% max	
IS-54 Spurious Power ^{2, 3}			
@ 30 kHz	-35	dB typ	
	-30	dB max	
@ 60 kHz	-70	dB typ	
	-65	dB max	
@ 90 kHz, 120 kHz	-75	dB typ	
	-70	dB max	
ANALOG MODE SPECIFICATIONS			
No. of Channels	2		(ITx - \overline{ITx}) and (QTx - \overline{QTx}) For Each Analog Output I Channel = (ITx - \overline{ITx}) and Q Channel = (QTx - \overline{QTx}) MCLK/16; $f_{MCLK} = 2.56\text{ MHz}$ Generating a 10 kHz Sine Wave
Resolution	10	Bits	
Output Signal Range	$V_{REF} \pm V_{REF}/3$	Volts	
Differential Output Range	$\pm 2V_{REF}/3$	Volts	
DAC Update Rate	160	kHz	
SNR	60	dB typ	
	55	dB min	
Differential Offset Error	± 15	mV max	
Group Delay Matching Between I & Q Outputs	30	ns typ	
Coding	Twos Complement		
Maximum and Minimum DAC Codes ⁴	+450/-450	max/min	
REFERENCE & CHANNEL SPECIFICATIONS			
Reference, V_{REF}	2.46	Volts	Measured @ 10 kHz Power = 0 V
Reference Accuracy	± 5	%	
I and Q Gain Matching	± 0.2	dB max	
Power-Down Option	Yes		
LOGIC INPUTS			
V_{INH} , Input High Voltage	$V_{DD} - 0.9$	V min	
V_{INL} , Input Low Voltage	0.9	V max	
I_{INH} , Input Current	10	FA max	
C_{IN} , Input Capacitance	10	pF max	
LOGIC OUTPUTS			
V_{OH} Output High Voltage	$V_{DD} - 0.4$	V min	$ I_{OUT} \leq 40\ \mu\text{A}$ $ I_{OUT} \leq 1.6\ \text{mA}$
V_{OL} Output Low Voltage	0.4	V max	
POWER SUPPLIES			
V_{DD}	4.5/5.5	V min/V max	POWER = V_{DD} MCLK Active MCLK Inactive
I_{DD}			
Transmit Section Active	8	mA max	
	6	mA typ	
Transmit Section Powered Down ⁵	35	μA max	
	5	μA max	

NOTES

¹Operating temperature ranges as follows: A Version: -40°C to $+85^\circ\text{C}$.

²See terminology.

³Measured in continuous transmission and Burst Mode with the I and Q channels ramping up and down at the beginning and end of a burst.

⁴Headroom must be allowed for the transmit DACs such that offsets in I & Q transmit channels can be calibrated out. Therefore, the full range of the I and Q DACs are not available to the user. The user should ensure that binary codes greater than or less than the maximum or minimum are not loaded into the I or Q DACs.

⁵Measured while the digital inputs to the transmit interface are static and equal to 0 V or V_{DD} .

Specifications subject to change without notice.

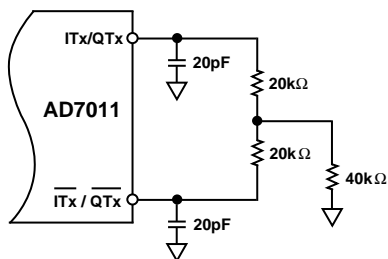

Figure 1. Analog Output Test Load Circuit

MASTER CLOCK TIMING ($V_{AA} = V_{DD} = +5\text{ V} \pm 10\%$; $AGND = DGND = 0\text{ V}$. All specifications are T_{MIN} to T_{MAX} unless otherwise noted.)

Parameter	Limit at $T_A = -40^\circ\text{C}$ to $+85^\circ\text{C}$	Units	Description
t_1	300	ns min	MCLK Cycle Time
t_2	100	ns min	MCLK High Time
t_3	100	ns min	MCLK Low Time

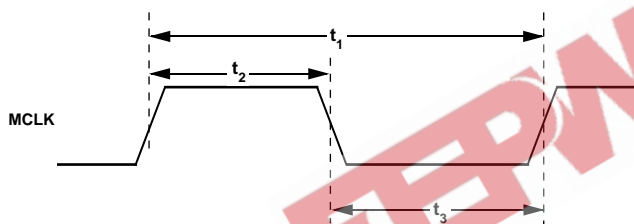

Figure 2. Master Clock (MCLK) Timing

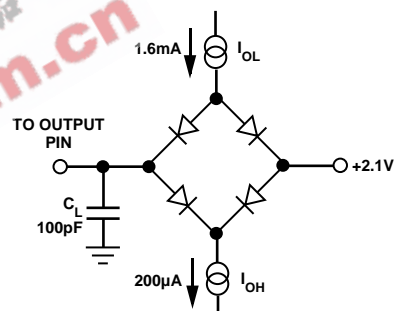

Figure 3. Load Circuit for Digital Outputs

AD7011

TRANSMIT SECTION TIMING ($V_{AA} = V_{DD} = +5\text{ V} \pm 10\%$; $AGND = DGND = 0\text{ V}$, $f_{MCLK} = 3.1104\text{ MHz}$. All specifications are T_{MIN} to T_{MAX} unless otherwise noted.)

Parameter	Limit at $T_A = -40^\circ\text{C}$ to $+85^\circ\text{C}$	Units	Description
t_4	10	ns min	Power Setup Time.
	$t_1 - 10$	ns max	
t_5	$4097t_1 + 70$	ns max	MCLK rising edge, after Power high, to READY rising edge.
t_6	10	ns min	BIN Setup Time.
	$t_1 - 10$	ns max	
t_7	$t_1 + 70$	ns max	MCLK to READY propagation delay.
t_8	$3t_1 + 70$	ns	MCLK rising edge, after BIN high, to first TxCLK rising edge.
t_9	$64t_1$	ns	TxCLK Cycle Time.
t_{10}	$32t_1$	ns	TxCLK High Time.
t_{11}	$32t_1$	ns	TxCLK Low Time.
t_{12}	50	ns min	TxCLK falling edge to TxDATA setup time.
t_{13}	0	ns min	TxCLK falling edge to TxDATA hold time.
t_{14}	$3t_1$	ns max	BIN low setup to Last transmitted symbol after ramp down.
t_{15}	$124t_1$	ns max	BIN low hold to Last transmitted symbol after ramp down.
t_{16}	$7.5t_9$	ns	Ramp Down cycle time after the last transmitted symbol.
t_{17}	$30t_1$	ns max	Last TxCLK falling edge to READY rising edge.
t_{18}	10	ns max	Digital Output Rise Time.
t_{19}	10	ns max	Digital Output Fall Time.

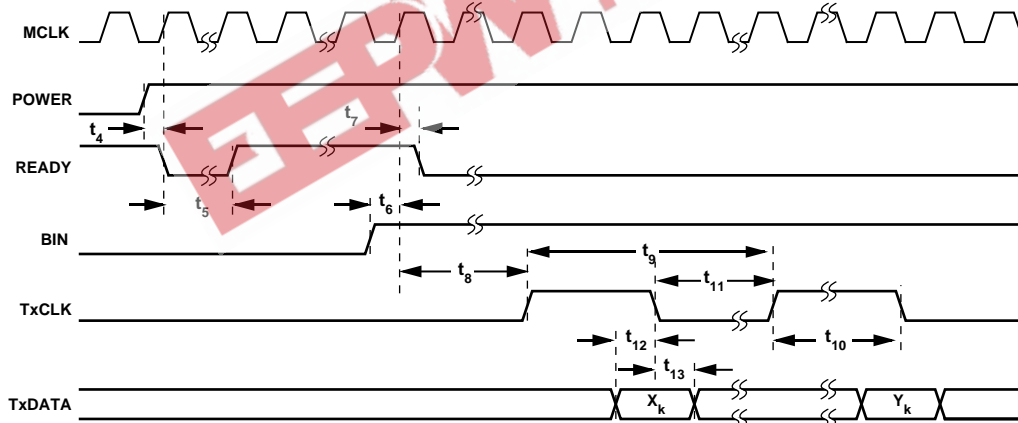

Figure 4. Transmit Timing at the Start of a Tx Burst

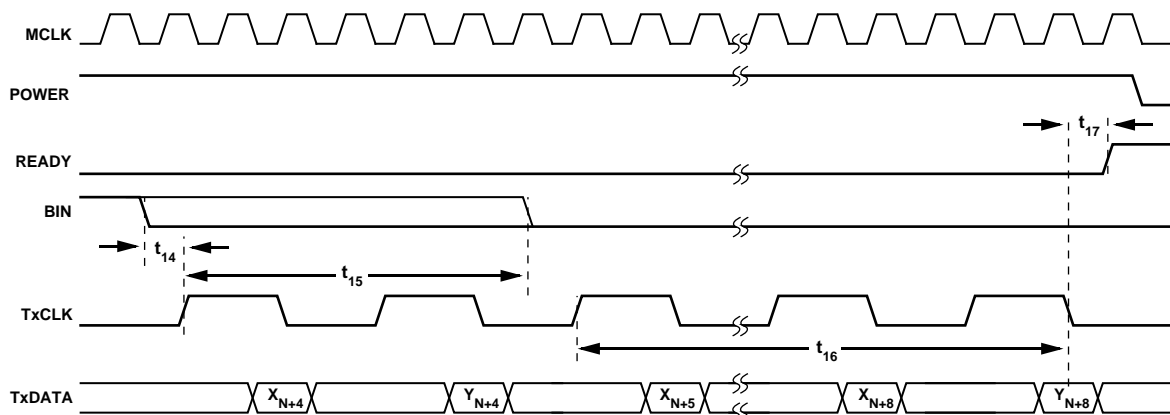

Figure 5. Transmit Timing at the End of a Tx Burst

ANALOG MODE TIMING ($V_{AA} = V_{DD} = +5\text{ V} \pm 10\%$. AGND = DGND = 0 V. All specifications are T_{MIN} to T_{MAX} unless otherwise noted.)

Parameter	Limit at $T_A = -40^\circ\text{C}$ to $+85^\circ\text{C}$	Units	Description
t_{20}	15	ns min	MCLK Rising Edge to FRAME Setup Time.
t_{21}	15	ns min	MCLK Rising Edge to FRAME Hold Time.
t_{22}	$15t_1$	ns max	FRAME Cycle Time.
t_{23}	$16t_1$	ns	MCLK Rising Edge to Data Setup Time.
t_{24}	15	ns min	MCLK Rising Edge to Data Hold Time.

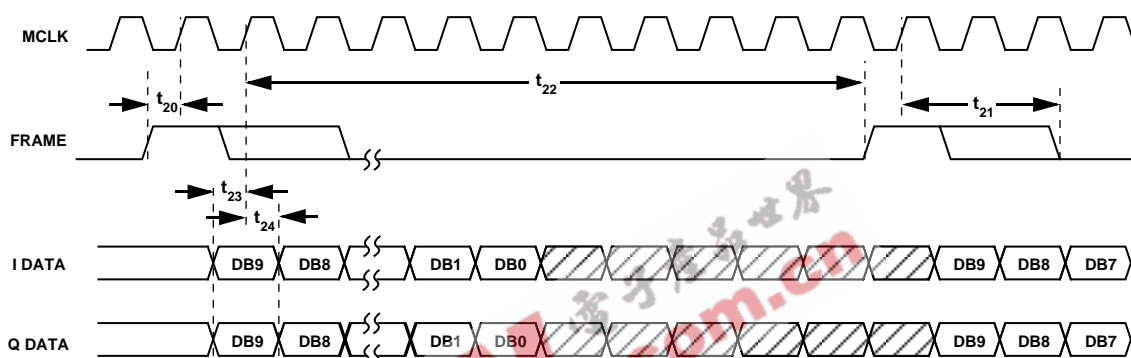

Figure 6. Analog Mode Serial Interface Timing

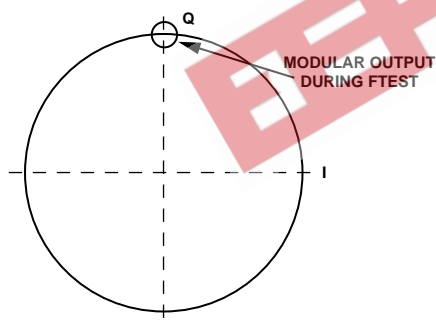

Figure 7. Modulator State During FTEST

Table I.

MODE 1	MODE 2	Operation
0	0	Digital TIA Mode
1	0	Analog Mode
0	1	FTEST
1	1	Factory Test, Reserved

Table II.

Mode of Operation	MODE 1	MODE 2	MCLK	Digital Bit Rate	DAC Update Rate
Digital Mode	0	0	3.1104 MHz	48.6 kHz	N/A
Analog Mode	1	0	2.56 MHz	N/A	160 kHz

AD7011

ABSOLUTE MAXIMUM RATINGS*

(T_A = +25°C unless otherwise noted)

V _{DD} Tx, V _{DD} Rx to AGND -0.3 V to +7 V
AGND to DGND -0.3 V to +0.3 V
Digital I/O Voltage to DGND -0.3 V to V _{DD} + 0.3 V
Analog I/O Voltage to AGND -0.3 V to V _{DD} + 0.3 V
Operating Temperature Range	
Industrial (A Version) -40°C to +85°C
Storage Temperature Range -65°C to +150°C

Junction Temperature +150°C
SSOP θ _{JA} Thermal Impedance +122°C/W
Lead Temperature, Soldering	
Vapor Phase (60 sec) +215°C
Infrared (15 sec) +220°C

*Stresses above those listed under "Absolute Maximum Ratings" may cause permanent damage to the device. This is a stress rating only and functional operation of the device at these or any other conditions above those listed in the operational sections of this specification is not implied. Exposure to absolute maximum rating conditions for extended periods may affect device reliability.

CAUTION

ESD (electrostatic discharge) sensitive device. Electrostatic charges as high as 4000 V readily accumulate on the human body and test equipment and can discharge without detection. Although this device features proprietary ESD protection circuitry, permanent damage may occur on devices subjected to high energy electrostatic discharges. Therefore, proper ESD precautions are recommended to avoid performance degradation or loss of functionality.



ORDERING GUIDE

Model	Temperature Range	Package Description	Package Option
AD7011ARS	-40°C to +85°C	Shrink Small Outline Package	RS-24

SSOP PIN CONFIGURATION

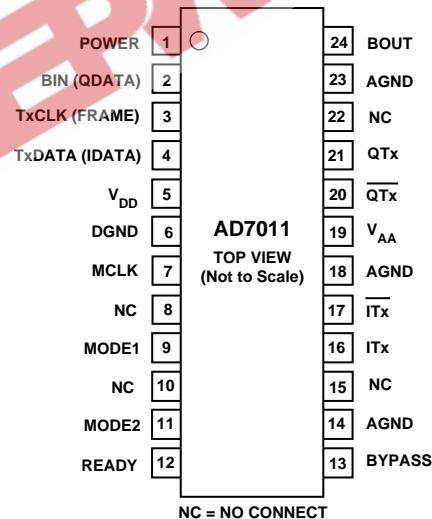

PIN FUNCTION DESCRIPTION

SSOP Pin		
Number	Mnemonic	Function
POWER SUPPLY		
19	V _{AA}	Positive power supply for analog section.
5	V _{DD}	Positive power supply for digital section.
14, 18, 23	AGND	Analog ground for transmit section.
6	DGND	Digital ground for transmit section.
ANALOG SIGNAL AND REFERENCE		
13	BYPASS	Reference decoupling output. A decoupling capacitor should be connected between this pin and AGND.
16, 17	ITx, \overline{ITx}	Differential analog outputs for the I channel, representing true and complementary outputs of the I waveform.
21, 20	QTx, \overline{QTx}	Differential analog outputs for the Q channel, representing true and complementary outputs of the Q waveform.
TRANSMIT INTERFACE AND CONTROL		
7	MCLK	Master clock, digital input. When operating in Mode 0 (TIA Digital mode), this pin should be driven by a 3.1104 MHz CMOS compatible clock source in digital mode and by 2.56 MHz CMOS compatible clock source for analog mode.
3	TxCLK (FRAME)	This is a dual function digital input/output. When operating in Mode 0 (TIA Digital mode), this pin is configured as a digital output, transmit clock. This may be used to clock in transmit data at 48.6 kHz. When operating in Mode 1 (analog mode), this pin is configured as a digital input, FRAME. This is used to frame the clocking in of 16-bit words when bypassing the $\pi/4$ DQPSK modulator and directly loading the I and Q 10-bit DACs.
4	TxDATA (IDATA)	This is a dual function digital input. When operating in Mode 0 (TIA Digital mode), this pin is used to clock in transmit data on the falling edge of TxCLK at a rate of 48.6 kHz. When operating in Mode 1 (Analog mode), I data is clocked in on the rising edge of MCLK. This data bypasses the $\pi/4$ DQPSK modulator and is loaded into the 10-bit I DAC.
2	BIN (QDATA)	This is a dual function digital input. When operating in Mode 0 (TIA Digital mode), this input is used to initiate the ramping up (BIN high) or down (BIN low) of the I and Q waveforms. When operating in Mode 1 (Analog mode), Q data is clocked in on the rising edge of MCLK. This data bypasses the $\pi/4$ DQPSK modulator and is loaded into the 10-bit Q DAC.
24	BOUT	Burst Out, digital output. This is the BIN input delayed by the pipeline delay, both digital and analog, of the AD7011. This can be used to turn on and off the RF amplifiers in synchronization with the I and Q waveforms.
1	POWER	Transmit sleep mode, digital input. When this goes low, the AD7011 goes into sleep mode, drawing minimal current. When this pin goes high, the AD7011 is brought out of sleep mode and initiates a self-calibration routine to eliminate the offset between ITx & \overline{ITx} and the offset between QTx & \overline{QTx} .
12	READY	Transmit ready, digital output. This output goes high once the self-calibration routine is complete.
9, 11	MODE1, MODE2	Mode control, digital inputs. These are used to enter the AD7011 into three different operating modes, see Table I.
8, 10, 15, 22	NC	No Connects. These pins are no connects and should not be used as routes for other circuit signals.

AD7011

TERMINOLOGY

Error Vector Magnitude

This is a measure of the rms error vector introduced by the AD7011 where signal error vector is defined as the rms deviation of a transmitted symbol from its ideal position when filtered by an Ideal RRC Receive filter, as illustrated in Figure 8.

Gain Matching Between Channels

The is the gain matching between the I and Q outputs, measured when transmitting all zeros.

Offset Vector Magnitude

This is a measure of the offset vector introduced by the AD7011 as illustrated in Figure 8. The offset vector is calculated so as to minimize the rms error vector for each of the constellation points.

Output Signal Range and Different Output Range

The output signal range is the output voltage swing and dc bias level for each of the analog outputs. The different output range is the difference between \overline{ITx} and $\overline{I\overline{T}x}$ for the I channel and the difference between \overline{QTx} and $\overline{Q\overline{T}x}$ for the Q Channel.

IS-54 Spurious Power

This is the rms sum of the spurious power measured at multiples of 30 kHz, in a root raised cosine window of ± 16.4 kHz, relative to twice the rms power in a RRC window in the 0 to 16.4 kHz band.

Signal Vector Magnitude

This is the radius of the IQ constellation diagram as illustrated in Figure 8.

Signal to (Noise + Distortion) Ratio

This is the measured ratio of signal to (noise + distortion) at the output of the transmit I and Q DACs. The signal is the rms amplitude of the fundamental. Noise is the rms sum of all non-fundamental signals up to half the sampling frequency ($f_s/2$), excluding dc. The ratio is dependent upon the number of quantization levels in the digitization process; the more levels, the smaller the quantization noise. The theoretical signal to (noise distortion) ratio for a sine wave is given by:

$$SNR = (6.02N + 1.76) \text{ dB}$$

where N is the number of bits. Thus for an ideal 10-bit converter, $SNR = 61.96$ dB.

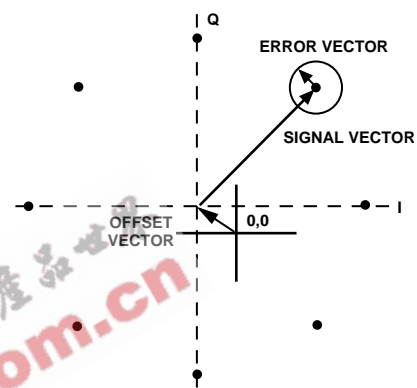

Figure 8.

CIRCUIT DESCRIPTION

TRANSMIT SECTION

The transmit section of the AD7011 generates $\pi/4$ DQPSK I and Q waveforms in accordance with TIA specification. This is accomplished by a digital $\pi/4$ DQPSK modulator, which includes the root-raised cosine filters ($\alpha = 0.35$), followed by two 10-bit DACs and on-chip reconstruction filters. The $\pi/4$ DQPSK (Differential Quadrature Phase Shift Keying) digital modulator generates 10-bit I and Q data in response to the transmit data stream. The 10-bit I and Q DACs are filtered by on-chip reconstruction filters, which also generate differential analog outputs for both I and Q channels.

The AD7011 transmit channel also provides an analog mode, where direct access to the I and Q DACs is provided, bypassing the $\pi/4$ DQPSK modulator. This is provided so that the AD7011 transmit channel can also be used to perform the conversion and filtering of the analog waveforms required to emulate the existing analog cellular system.

$\pi/4$ DQPSK Modulator

The $\pi/4$ DQPSK modulator generates 10-bit I and Q data (Inphase and Quadrature) which are loaded into the I and Q 10-bit transmit DACs.

Figure 9 shows the functional block diagram of the $\pi/4$ DQPSK modulator. The transmit serial data (TxDATA) is first converted into Di-bit symbols $[X_k, Y_k]$, using a 2-bit serial to parallel converter. The data is then differentially encoded; symbols are transmitted as changes in phase rather than absolute phases. Each symbol represents a phase change, as illustrated in Table III, and this along with the previously transmitted symbol determines the next symbol to be transmitted. The differential phase encoder generates I and Q impulses $[I_k, Q_k]$ in response to the Di-bit symbols according to:

$$I_k = \text{COS} [\phi_{k-1} + \Delta\phi_k]$$

$$Q_k = \text{SIN} [\phi_{k-1} + \Delta\phi_k]$$

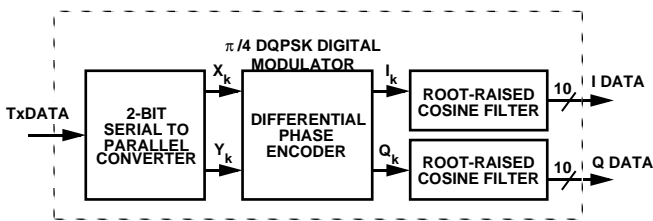

Figure 9. $\pi/4$ DQPSK Modulator Functional Block Diagram

Table III.

X_k	Y_k	$\Delta\phi_k$
1	1	$-\frac{3\pi}{4}$
0	1	$\frac{3\pi}{4}$
0	0	$\frac{\pi}{4}$
1	0	$-\frac{\pi}{4}$

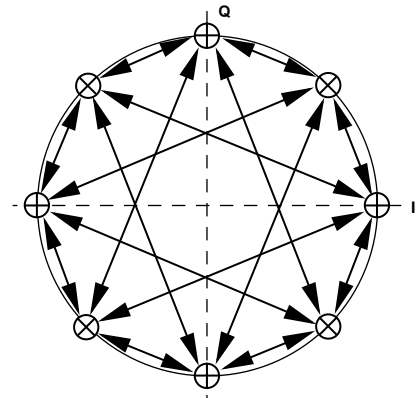

Figure 10. $\pi/4$ DQPSK Constellation Diagram

Figure 10 illustrates the $\pi/4$ DQPSK constellation diagram as described above, showing the eight possible states for $[I_k, Q_k]$.

The I_k and Q_k impulses are then filtered by FIR raised root cosine filters ($\alpha = 0.35$), generating 10-bit I and Q data. The FIR root raised cosine filters have an impulse response of ± 4 symbols.

Transmit Calibration

When the transmit section is brought out of sleep mode (POWER high), the transmit section initiates a self-calibration routine to remove the offset between I_{Tx} and \bar{I}_{Tx} and an offset between Q_{Tx} and \bar{Q}_{Tx} . READY goes high on the completion of the self-calibration routine. Once READY goes high, BIN (Burst In) can be brought high to initiate a transmit burst.

Ramp-Up/Down Envelope Logic

The AD7011 provides on-chip envelope shaping logic, providing power shaping control for the beginning and end of a transmit burst. When BIN (Burst In) is brought high, the modulator is reset to a transmitting all zeros state (i.e., $X_k = Y_k = 0$) and continues to transmit all zeros for the first three symbols, during which the ramp-up envelope goes from zero to full scale as illustrated in Figure 11. The next symbol to be transmitted is $[I_1, Q_1]$, which represents the first two data bits clocked in after BIN going high, i.e., $[X_1, Y_1]$.

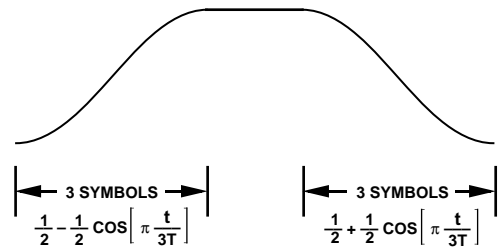

Figure 11. Ramp Envelope

When BIN is brought low, indicating the end of a transmit burst, the current Di-bit symbol $[X_{N+4}, Y_{N+4}]$ that the AD7011 is receiving will be the last symbol to be computed for the four symbol ramp-down sequence. Also the N^{th} symbol is the last active symbol prior to ramping down.

However, because the impulse response is equal to ± 4 symbols, four additional symbols are required to fully compute the analog outputs when transmitting the $(N+4)^{th}$ symbol. Hence there will be eight subsequent TxCLKs, latching four additional Di-bit symbols: $[X_{N+5}, Y_{N+5}]$ to $[X_{N+8}, Y_{N+8}]$.

AD7011

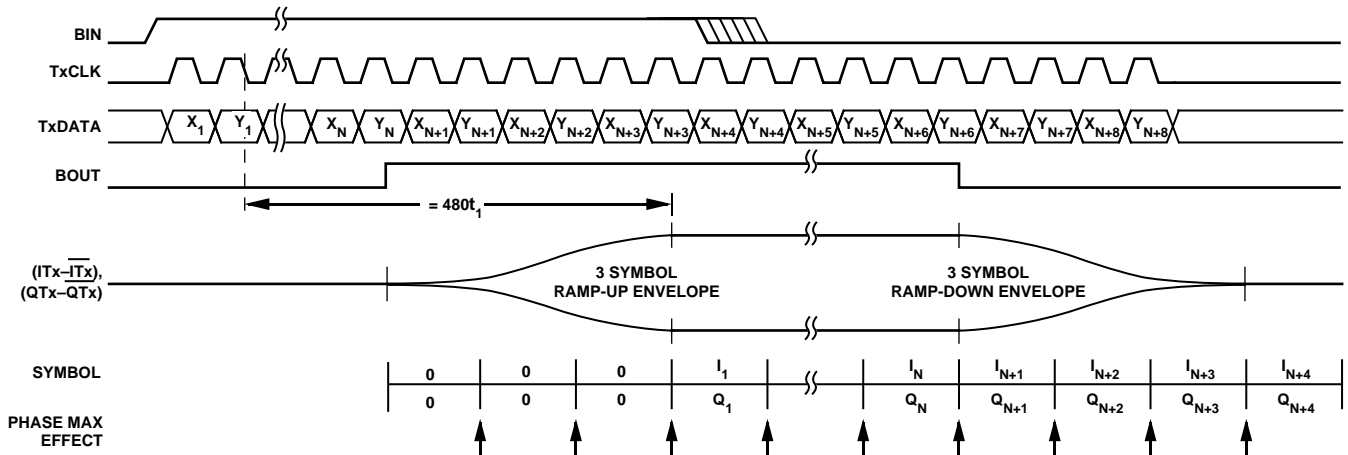

Figure 12. Transmit Burst

As Figure 12 illustrates, the ramp-down envelope reaches zero after three symbols, hence the fourth symbol does not actually get transmitted.

Reconstruction Filters

The reconstruction filters smooth the DAC output signals, providing continuous time I and Q waveforms at the output pins. These are 4th order Bessel low-pass filters with a -3 dB frequency of approximately 25 kHz. The filters are designed to have a linear phase response in the passband and due to the reconstruction filters being on-chip, the phase mismatch between the I and Q transmit channels is kept to a minimum.

Transmit Section Digital Interface

$MODE1 = MODE2 = DGND$: *Digital $\pi/4$ DQPSK Mode*

Figures 4 and 5 shows the timing diagrams for the transmit interface when operating in TIA $\pi/4$ DQPSK mode. POWER is sampled on the rising edge of MCLK. When POWER is brought high, the transmit section is brought out of sleep mode and initiates a self-calibration routine as described above. Once the self-calibration is complete, the READY signal goes high to indicate that a transmit burst can now begin. BIN (Burst in) is brought high to initiate a transmit burst and should only be brought high if the READY signal is already high.

When BIN goes high, the READY signal goes low on the next rising edge of MCLK and TxCLK becomes active after a further three MCLK cycles. TxCLK can be used to clock out the transmit data from the ASIC or DSP on the rising edge of TxCLK and the AD7011 will latch TxDATA on the falling edge of TxCLK.

When BIN is brought low, the AD7011 will continue to clock in the current Di-bit symbol (X_{N+4}, Y_{N+4}) and will continue for a further 8 TxCLK cycles (four symbols). After the final TxCLK, READY goes high waiting for BIN to be brought high to begin the next transmit burst.

When POWER is brought low this puts the transmit section into a low power sleep mode, drawing minimal current. The analog outputs go high impedance while in low power sleep mode.

$MODE1 = V_{DD}; MODE2 = DGND$: *Analog Mode*

Figure 6 shows the timing diagram for the transmit interface when operating in analog mode. In this mode the $\pi/4$ DQPSK modulator is bypassed and direct access to the I and Q 10-bit DACs is provided. Loading of the I and Q DACs is accomplished using a 4 wire 16-bit serial interface. The pins TxCLK, TxDATA and BIN are all reconfigured as inputs, with the functions of FRAME, IDATA and QDATA respectively.

I and Q data are loaded via the IDATA and QDATA pins and FRAME synchronizes the loading of the 16-bit I and Q words. FRAME should be brought high one clock cycle prior to the I and Q MSBs. Data is latched on the rising edge of MCLK, MSB first, where only the first 10 data bits are significant. Continuous updating of the I and Q DACs is required at a rate of MCLK/16.

$MODE1 = DGND; MODE2 = V_{DD}$: *Frequency Test Mode*

A special FTEST (Frequency TEST) mode is provided for the customer, where no phase modulation takes place and the modulator outputs remain static. ITx is set to zero and QTx is set to full scale as Figure 7 illustrates. However, the normal ramp-up/down envelope is still applied during the beginning and end of a burst.

$MODE1 = MODE2 = V_{DD}$: *Factory Test Mode*

This mode is reserved for factory test only and should not be used by the customer for correct device operation.

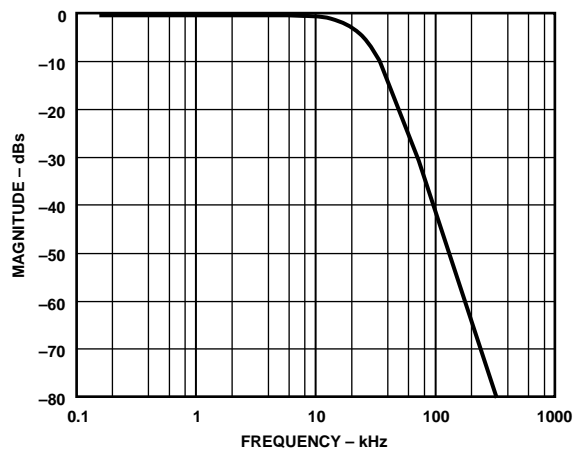

Figure 13. Reconstruction Filter Frequency Response for the I and Q DACs, MCLK = 2.56 MHz

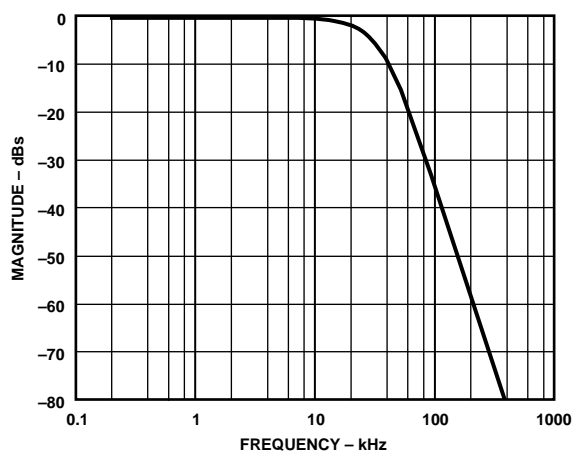

Figure 16. Reconstruction Filter Frequency Response for the I and Q DACs, MCLK = 3.1104 MHz

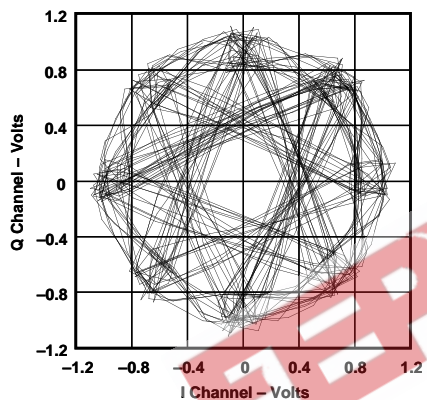

Figure 14. AD7011 I vs. Q Waveforms When Transmitting Random Data

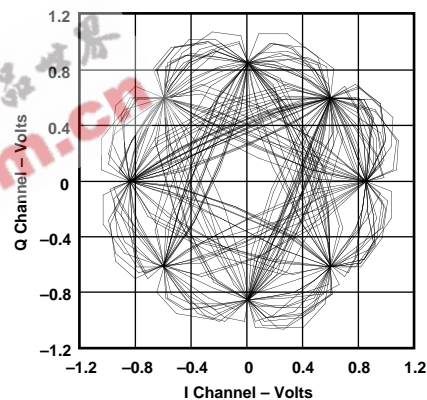

Figure 17. AD7011 I vs. Q Waveforms Filtered by an Ideal Root Raised Cosine Receive Filter

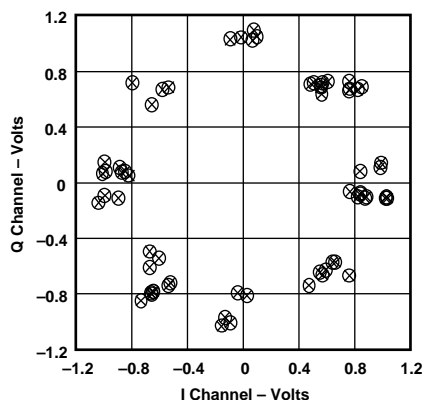

Figure 15. AD7011 Transmit Constellation Diagram

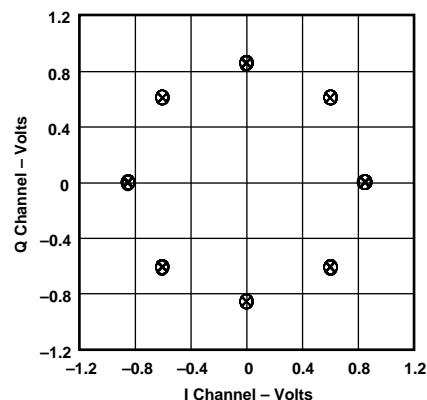

Figure 18. AD7011 Constellation Diagram When Filtered by an Ideal Root Raised Cosine Receive Filter

AD7011

OUTLINE DIMENSIONS

Dimensions shown in inches and (mm).

24-Lead SSOP (RS-24)

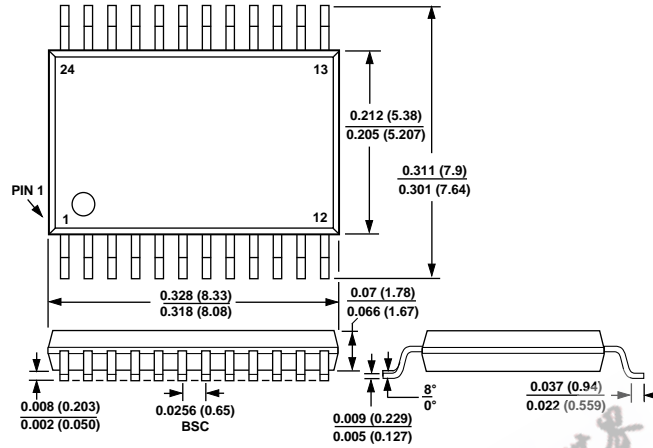

1. LEAD NO. 1 IDENTIFIED BY A DOT.
2. LEADS WILL BE EITHER TIN PLATED OR SOLDER DIPPED IN ACCORDANCE WITH MIL-M-38510 REQUIREMENTS

EEPW.com.cn 电子产业世界