

*Resonator***Piezoelectric Resonator** (4 to 20 MHz)**FAR Family (C3 series M/N type)****DESCRIPTION**

The features of the C3 series (M,N Type) resonators are compact and high stability. They are fabricated on a lithium tantalate (LiTaO_3) substrate, producing resonators with ultra compact and superior stability due to the high electromechanical coupling coefficient of the material.

They include two loading capacitors inside and are housed in chip type of package for surface mount. These contribute saving mount space and reducing cost.

FEATURES

- High stability (Overall frequency deviation; 0.10% max)
- Ultra small package
- Wide frequency range in 4 MHz to 20 MHz
- Suitable for microcomputer clock
- Emboss-typed pack for automatic mounting
- Superior shock and vibration resistance, preventing damage during automatic mounting

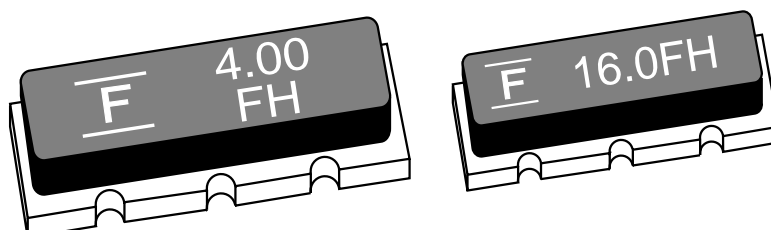
PACKAGE

FAR Family (C3 series M/N type)

STANDARD CHARACTERISTICS

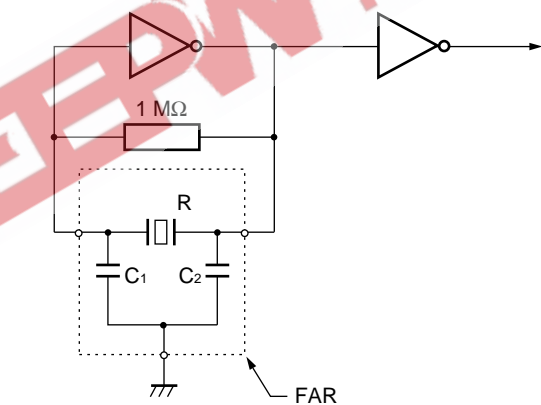
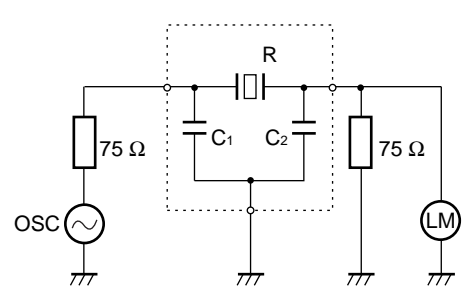
Item	Series	C3 series	Remarks
Material		Lithium Tantalate (LiTaO ₃)	
Frequency		4 MHz to 20 MHz	
Standard frequency		See "■ Standard Frequency."	
Initial frequency deviation		+0.025% (F), ±0.05% (G) -0.035%	±0.1% (J) and ± 0.3% (K) are also available upon request.
Temperature characteristics		+0.035% -0.025% (Within -10°C to +60°C)	Reference temperature: +25°C
Capacity of built-in capacitor		20 ±8 pF (Standard)	10 ±4 pF are also available. Capacity is specified by Fujitsu, considering matching data with applied IC (mainly microcomputer).
Operating temperature		-30°C to +85°C	
Storage temperature		-40°C to +100°C	
Standard measuring circuit		<ul style="list-style-type: none"> Oscillation frequency  <ul style="list-style-type: none"> Serial resonant resistance 	<p>Microcomputer 1/6MC74ACO4 × 2 (4 MHz to 8 MHz) 1/6TC74ACO4 × 2 (8 MHz to 20 MHz)</p> <ul style="list-style-type: none"> V_{CC} = 5.0 V DC R: Resonator C₁, C₂: Loading capacitors (built-in) <p>R: Resonator Measuring equipment: Spectrum analyzer</p>

FAR Family (C3 series M/N type)

■ STANDARD FREQUENCY

Standard frequency (kHz)	Package size	Resonant resistance
4,000 4,194	M	300 Ω max. (Symbol: 0)
6,000 8,000 10,000 12,000 16,000 16,934 20,000	N	150 Ω max. (Symbol: 1)

Notes:

- Fujitsu can also develop another frequency device besides standard devices within 4 MHz to 20 MHz.
- Regarding resonant resistance, maximum standard values are specified depending on frequency.

■ NOTES ON USE

- Handle carefully.
- Solder heat resistance.
5 seconds max. at +230°C (on PCB)
Recommended preheating is +150°C for one minute for avoiding giving extreme heat fluctuation to resonator.
- Avoid using resonator under condition of extreme temperature fluctuation.
- There is no specific direction in resonator mounting.
- Oscillation data must be considered in case that this resonator is used as microcomputer clock.
- Resonator is designed for reflow solder, not for flow solder.

FAR Family (C3 series M/N type)

■ PART NUMBERING SYSTEM

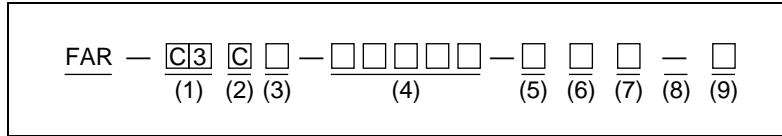

(1) Series

Series	Material	Capacitors
C3	LiTaO ₃	Built-in type

(2) Package type

Symbol	Type
C	Chip

(3) Package size

Symbol	Size
M	4.5 × 10.0 × 2.0 mm (4.0 MHz to 5.9 MHz)
N	3.2 × 8.0 × 1.6 mm (6.0 MHz to 20.0 MHz)

(4) Oscillation frequency

Frequency is specified with 5-digit in kHz of unit.

Frequency	Symbol
[Example] 8.000 MHz	08000

See “■ Standard Frequency.”

(5) Initial frequency deviation

Symbol	Deviation
F	+0.025% −0.035%
G	±0.05%
J	±0.1%
K	±0.3%

(6) Built-in capacitors

Symbol	Capacitor
0	20 ±8 pF
1	10 ±4 pF

FAR Family (C3 series M/N type)

(7) Resonant resistance

Symbol	Resistance
0	300 Ω max.
1	150 Ω max.

(8) Special mark

Symbol	Content
Space	Standard device, no taping specification
—	Standard device, with Tape & Reel
H to Z	Serial number for custom design

(9) Taping specification

Symbol	Content
R	16 mm width emboss tape (3,000 pcs/reel)

EEPW.com.cn 电子产业网

FAR Family (C3 series M/N type)

MARKING

The diagram shows a rectangular marking area containing the text 'F 12.0 F n'. The 'F' at the beginning is underlined and labeled 'Fujitsu logo'. The '12.0 F' is enclosed in a dashed box and labeled 'Frequency (MHz)'. The 'n' at the end is labeled 'Lot No. (Date of manufacture, conforms to EIAJ)'.

Note: The stamp varies in color according to the built-in capacitor.

Capacitor	Marking color
10 pF	Yellow
20 pF	White

Data code (EIAJ standard) is specified as follows in four-year cycle.

Year	Month	Mark	Year	Month	Mark	Year	Month	Mark	Year	Month	Mark
1997 2001	1	A	1998 2002	1	N	1999 2003	1	a	2000 2004	1	n
	2	B		2	P		2	b		2	o
	3	C		3	Q		3	c̄		3	q
	4	D		4	R		4	d		4	r
	5	F		5	S		5	e		5	s
	6	G		6	T		6	f		6	t
	7	H		7	U		7	g		7	u
	8	I		8	V		8	h		8	v
	9	J		9	W		9	j		9	w
	10	K		10	X		10	k		10	x
	11	L		11	Y		11	l		11	y
	12	M		12	Z		12	m		12	z

FAR Family (C3 series M/N type)

■ PIN ASSIGNMENT

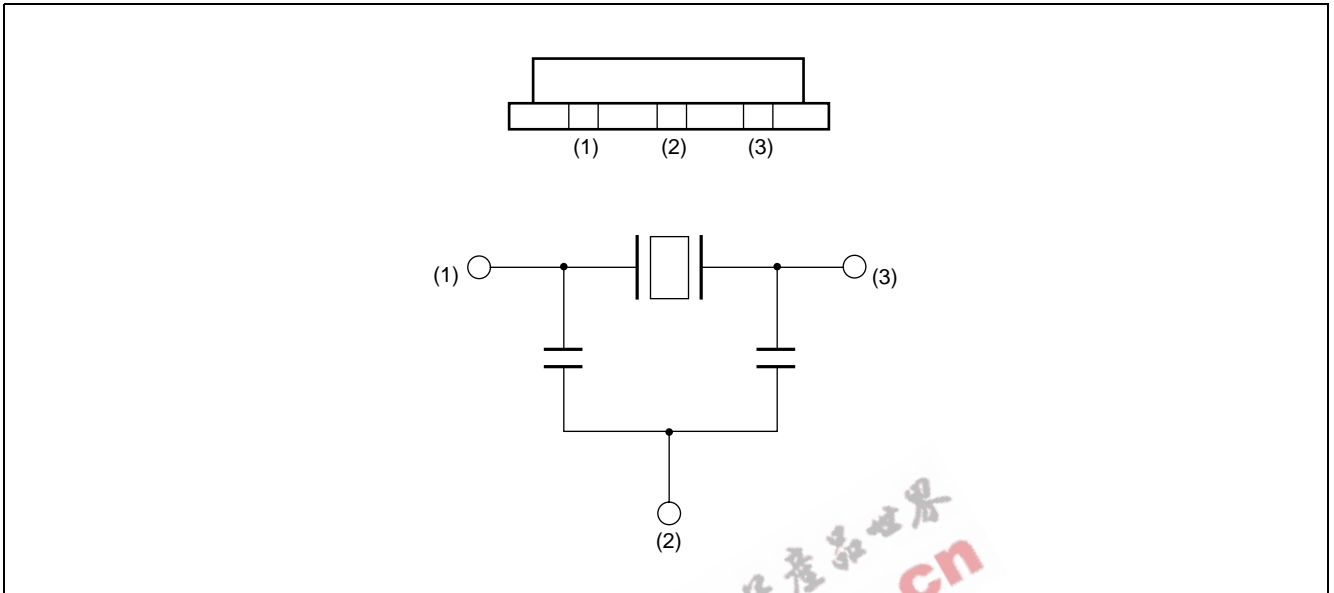

■ DIMENSIONS

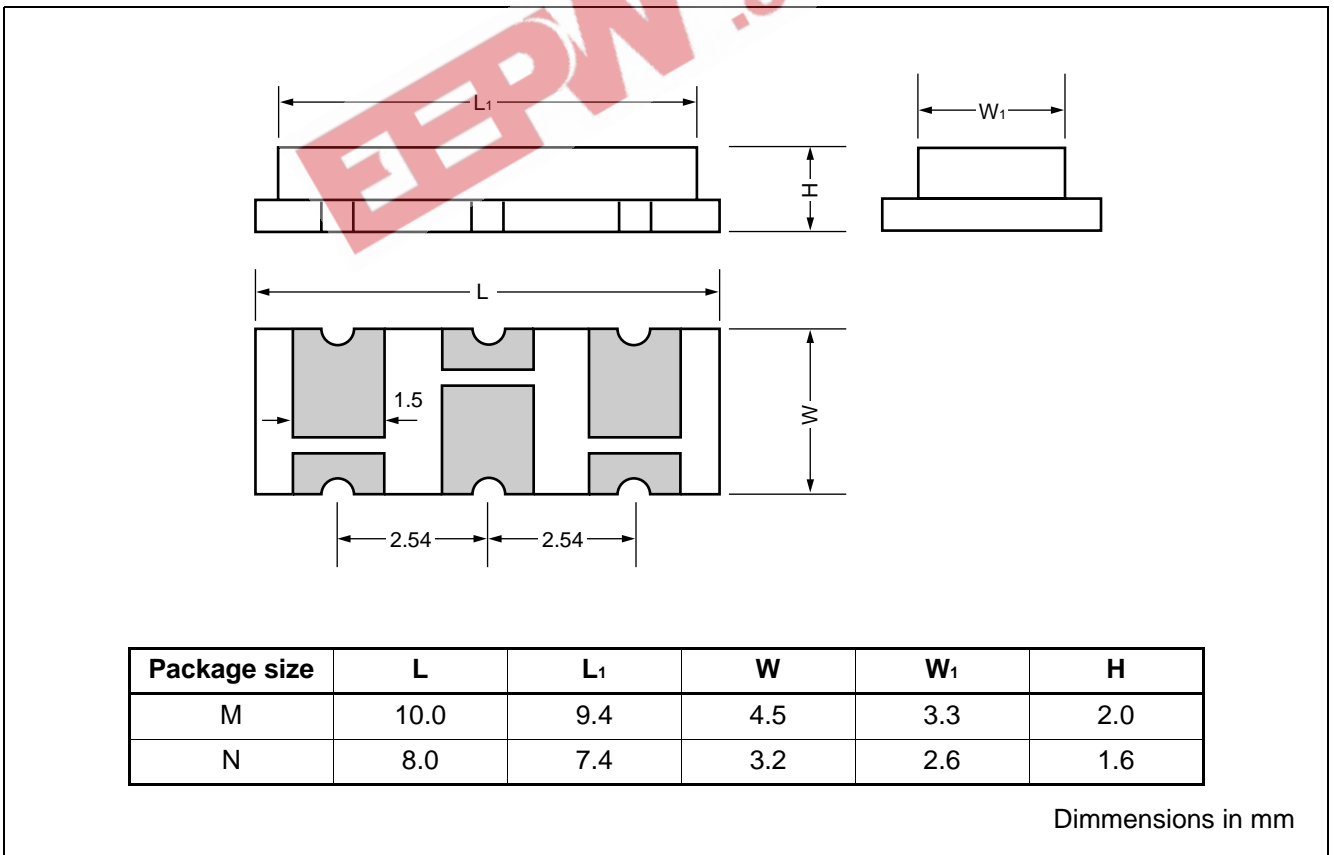

FAR Family (C3 series M/N type)

■ TAPING FORM AND DIMENSIONS

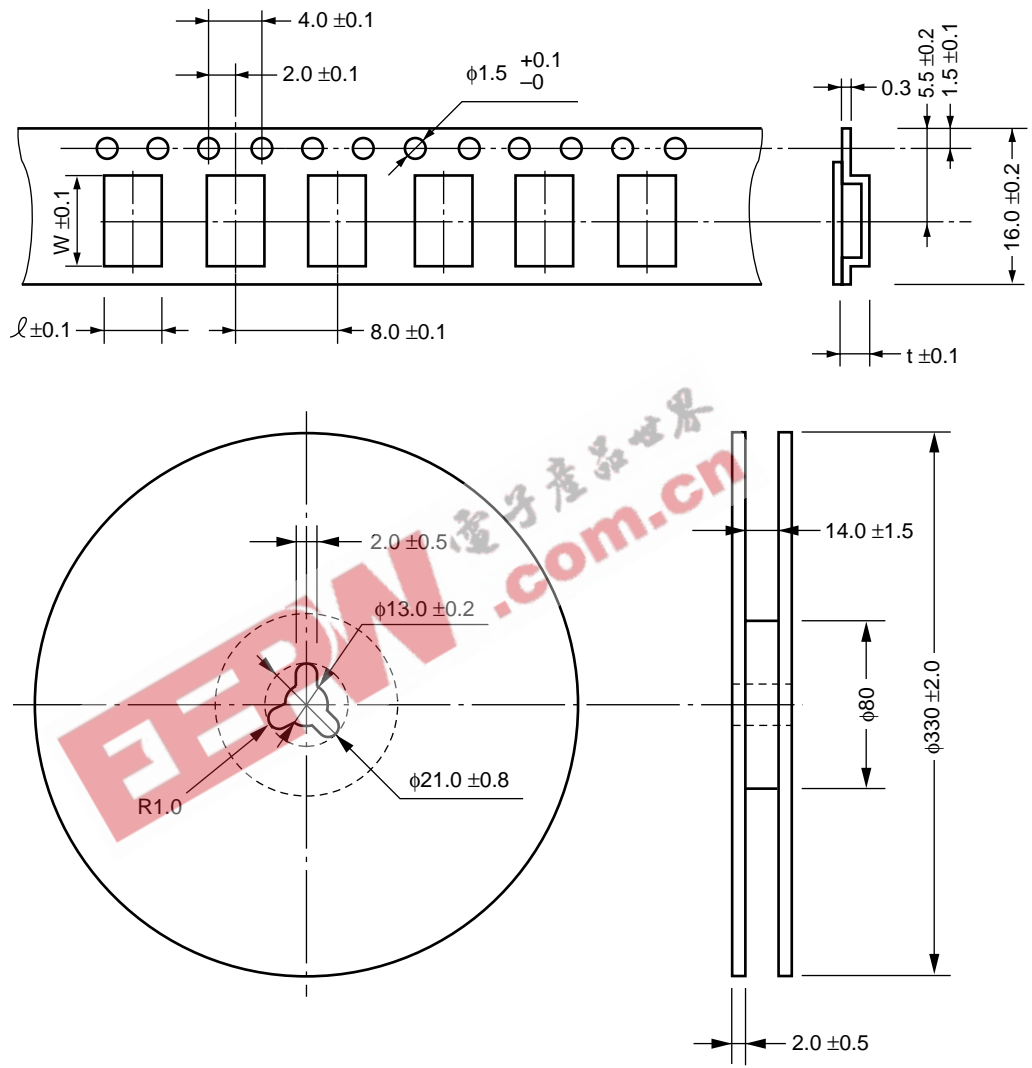

Package size	l	W	t
M	5.0	10.5	3.0
N	3.7	8.5	2.1

• Pack quantity

Package size	Quantity
M, N	3,000

Dimensions in mm

FAR Family (C3 series M/N type)

FUJITSU LIMITED

For further information please contact:

Japan

FUJITSU LIMITED
Corporate Global Business Support Division
Electronic Devices
KAWASAKI PLANT, 4-1-1, Kamikodanaka
Nakahara-ku, Kawasaki-shi
Kanagawa 211-88, Japan
Tel: (044) 754-3763
Fax: (044) 754-3329

<http://www.fujitsu.co.jp/>

North and South America

FUJITSU MICROELECTRONICS, INC.
Semiconductor Division
3545 North First Street
San Jose, CA 95134-1804, U.S.A.
Tel: (408) 922-9000
Fax: (408) 922-9179

Customer Response Center
Mon. - Fri.: 7 am - 5 pm (PST)
Tel: (800) 866-8608
Fax: (408) 922-9179

<http://www.fujitsumicro.com/>

Europe

FUJITSU MIKROELEKTRONIK GmbH
Am Siebenstein 6-10
D-63303 Dreieich-Buchsschlag
Germany
Tel: (06103) 690-0
Fax: (06103) 690-122

<http://www.fujitsu-edc.com/>

Asia Pacific

FUJITSU MICROELECTRONICS ASIA PTE LTD
#05-08, 151 Lorong Chuan
New Tech Park
Singapore 556741
Tel: (65) 281-0770
Fax: (65) 281-0220

<http://www.fmap.com.sg/>

F9801

© FUJITSU LIMITED Printed in Japan

All Rights Reserved.

The contents of this document are subject to change without notice. Customers are advised to consult with FUJITSU sales representatives before ordering.

The information and circuit diagrams in this document presented as examples of semiconductor device applications, and are not intended to be incorporated in devices for actual use. Also, FUJITSU is unable to assume responsibility for infringement of any patent rights or other rights of third parties arising from the use of this information or circuit diagrams.

FUJITSU semiconductor devices are intended for use in standard applications (computers, office automation and other office equipment, industrial, communications, and measurement equipment, personal or household devices, etc.).

CAUTION:

Customers considering the use of our products in special applications where failure or abnormal operation may directly affect human lives or cause physical injury or property damage, or where extremely high levels of reliability are demanded (such as aerospace systems, atomic energy controls, sea floor repeaters, vehicle operating controls, medical devices for life support, etc.) are requested to consult with FUJITSU sales representatives before such use. The company will not be responsible for damages arising from such use without prior approval.

Any semiconductor devices have inherently a certain rate of failure. You must protect against injury, damage or loss from such failures by incorporating safety design measures into your facility and equipment such as redundancy, fire protection, and prevention of over-current levels and other abnormal operating conditions.

If any products described in this document represent goods or technologies subject to certain restrictions on export under the Foreign Exchange and Foreign Trade Control Law of Japan, the prior authorization by Japanese government should be required for export of those products from Japan.