

## FSTD3125 4-Bit Bus Switch with Level Shifting

### General Description

The Fairchild Switch FSTD3125 provides four high-speed CMOS TTL-compatible bus switches. The low On Resistance of the switch allows inputs to be connected to outputs without adding propagation delay or generating additional ground bounce noise. A diode to  $V_{CC}$  has been integrated into the circuit to allow for level shifting between 5V inputs and 3.3V outputs.

The device is organized as four 1-bit switches with separate  $\overline{OE}$  inputs. When  $\overline{OE}$  is LOW, the switch is ON and Port A is connected to Port B. When  $\overline{OE}$  is HIGH, the switch is OPEN and a high-impedance state exists between the two ports.

### Features

- 4Ω switch connection between two ports
- Minimal propagation delay through the switch
- Low  $I_{CC}$
- Zero bounce in flow-through mode
- Control inputs compatible with TTL level
- TruTranslation™ voltage translation from 5.0V inputs to 3.3V outputs

### Ordering Code:

| Order Number   | Package Number | Package Description   |
|----------------|----------------|---|
| FSTD3125M      | M14A           | 14-Lead Small Outline Integrated Circuit (SOIC), JEDEC MS-012, 0.150" Narrow        |
| FSTD3125QSC    | MQA16          | 16-Lead Quarter Size Outline Package (QSOP), JEDEC MO-137, 0.150" Wide              |
| FSTD3125MTC    | MTC14          | 14-Lead Thin Shrink Small Outline Package (TSSOP), JEDEC MO-153, 4.4mm Wide         |
| FSTD3125MTC_NL | MTC14          | Pb-Free 14-Lead Thin Shrink Small Outline Package (TSSOP), JEDEC MO-153, 4.4mm Wide |

Devices also available in Tape and Reel. Specify by appending the suffix letter "X" to the ordering code.  
Pb-Free package per JEDEC J-STD-020B.

### Connection Diagrams

Pin Assignment for SOIC and TSSOP

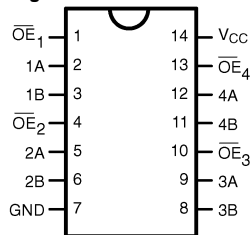

Pin Assignment for QSOP

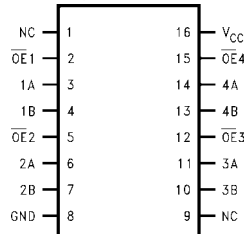

TruTranslation™ is a trademark of Fairchild Semiconductor Corporation.

### Pin Descriptions

| Pin Name   | Description        |
|--|--------------------|
| $\overline{OE}_1, \overline{OE}_2, \overline{OE}_3, \overline{OE}_4$ | Bus Switch Enables |
| 1A, 2A, 3A, 4A   | Bus A              |
| 1B, 2B, 3B, 4B   | Bus B              |
| NC   | Not Connected      |

### Truth Table

| Inputs          | Inputs/Outputs |
|-----------------|----------------|
| $\overline{OE}$ | A, B           |
| L               | A = B          |
| H               | Z              |

FSTD3125

### Logic Diagram

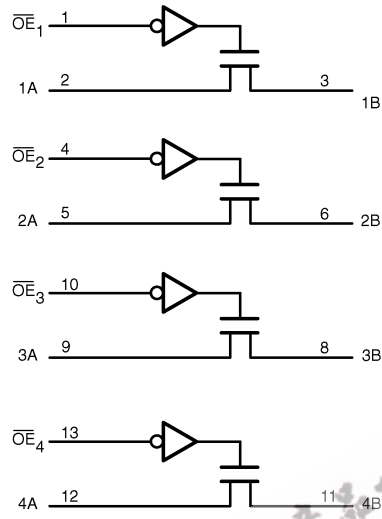

EEPW.com.cn 电子产品世界

**Absolute Maximum Ratings** (Note 1)

|   |                  |
|---|------------------|
| Supply Voltage ( $V_{CC}$ )                       | -0.5V to +7.0V   |
| DC Switch Voltage ( $V_S$ )                       | -0.5V to +7.0V   |
| DC Input Voltage ( $V_{IN}$ ) (Note 2)            | -0.5V to +7.0V   |
| DC Input Diode Current ( $I_{IK}$ ) $V_{IN} < 0V$ | -50 mA           |
| DC Output ( $I_{OUT}$ ) Sink Current              | 128 mA           |
| DC $V_{CC}/GND$ Current ( $I_{CC}/I_{GND}$ )      | +/- 100 mA       |
| Storage Temperature Range ( $T_{STG}$ )           | -65°C to +150 °C |

**Recommended Operating Conditions** (Note 3)

|  |                  |
|--|------------------|
| Power Supply Operating ( $V_{CC}$ )      | 4.5V to 5.5V     |
| Input Voltage ( $V_{IN}$ )               | 0V to 5.5V       |
| Output Voltage ( $V_{OUT}$ )             | 0V to 5.5V       |
| Input Rise and Fall Time ( $t_r, t_f$ )  |                  |
| Switch Control Input                     | 0 ns/V to 5 ns/V |
| Switch I/O                               | 0 ns/V to DC     |
| Free Air Operating Temperature ( $T_A$ ) | -40 °C to +85 °C |

**Note 1:** The "Absolute Maximum Ratings" are those values beyond which the safety of the device cannot be guaranteed. The device should not be operated at these limits. The parametric values defined in the Electrical Characteristics tables are not guaranteed at the absolute maximum rating. The "Recommended Operating Conditions" table will define the conditions for actual device operation.

**Note 2:** The input and output negative voltage ratings may be exceeded if the input and output diode current ratings are observed.

**Note 3:** Unused control inputs must be held HIGH or LOW. They may not float.

**DC Electrical Characteristics**

| Symbol          | Parameter                        | $V_{CC}$<br>(V) | $T_A = -40\text{ °C to }+85\text{ °C}$ |                 |           | Units         | Conditions  |
|-----------------|----------------------------------|-----------------|--|-----------------|-----------|---------------|---|
|                 |                                  |                 | Min                                    | Typ<br>(Note 4) | Max       |               |   |
| $V_{IK}$        | Clamp Diode Voltage              | 4.5             |  |                 | -1.2      | V             | $I_{IN} = -18\text{ mA}$  |
| $V_{IH}$        | HIGH Level Input Voltage         | 4.5-5.5         | 2.0                                    |                 |           | V             |   |
| $V_{OH}$        | HIGH Level                       | 4.0-5.5         | Figure 3                               |                 |           | V             |   |
| $V_{IL}$        | LOW Level Input Voltage          | 4.5-5.5         |  |                 | 0.8       | V             |   |
| $I_I$           | Input Leakage Current            | 5.5             |  |                 | $\pm 1.0$ | $\mu\text{A}$ | $0 \leq V_{IN} \leq 5.5V$   |
|                 |                                  | 0               |  |                 | 10        | $\mu\text{A}$ | $V_{IN} = 5.5V$   |
| $I_{OZ}$        | OFF-STATE Leakage Current        | 5.5             |  |                 | $\pm 1.0$ | $\mu\text{A}$ | $0 \leq A, B \leq V_{CC}$   |
| $R_{ON}$        | Switch On Resistance<br>(Note 5) | 4.5             |  | 4               | 7         | $\Omega$      | $V_{IN} = 0V, I_{IN} = 64\text{ mA}$                              |
|                 |                                  | 4.5             |  | 4               | 7         | $\Omega$      | $V_{IN} = 0V, I_{IN} = 30\text{ mA}$                              |
|                 |                                  | 4.5             |  | 35              | 50        | $\Omega$      | $V_{IN} = 2.4V, I_{IN} = 1.5\text{ mA}$                           |
| $I_{CC}$        | Quiescent Supply Current         | 5.5             |  |                 | 1.5       | mA            | $OE_1 = OE_2 = GND$<br>$V_{IN} = V_{CC}$ or GND, $I_{OUT} = 0$    |
|                 |                                  |                 |  |                 | 10        | $\mu\text{A}$ | $OE_1 = OE_2 = V_{CC}$<br>$V_{IN} = V_{CC}$ or GND, $I_{OUT} = 0$ |
| $\Delta I_{CC}$ | Increase in $I_{CC}$ per Input   | 5.5             |  |                 | 2.5       | mA            | One Input at 3.4V.<br>Other Inputs at $V_{CC}$ or GND             |

**Note 4:** Typical values are at  $V_{CC} = 5.0V$  and  $T_A = +25\text{ °C}$

**Note 5:** Measured by the voltage drop between A and B pins at the indicated current through the switch. On Resistance is determined by the lower of the voltages on the two (A or B) pins.

## AC Electrical Characteristics

| Symbol                              | Parameter                                | T <sub>A</sub> = -40 °C to +85 °C,<br>C <sub>L</sub> = 50pF, R <sub>U</sub> = R <sub>D</sub> = 500Ω |      | Units | Conditions   | Figure Number |
|-------------------------------------|--|---|------|-------|--|---------------|
|                                     |  | V <sub>CC</sub> = 4.5 - 5.5V  |      |       |  |               |
|                                     |  | Min   | Max  |       |  |               |
| t <sub>PHL</sub> , t <sub>PLH</sub> | Propagation Delay Bus to Bus<br>(Note 6) |   | 0.25 | ns    | V <sub>I</sub> = OPEN  | Figures 1, 2  |
| t <sub>PZH</sub> , t <sub>PZL</sub> | Output Enable Time                       | 1.0   | 6.1  | ns    | V <sub>I</sub> = 7V for t <sub>PZL</sub><br>V <sub>I</sub> = OPEN for t <sub>PZH</sub> | Figures 1, 2  |
| t <sub>PHZ</sub> , t <sub>PLZ</sub> | Output Disable Time                      | 1.5   | 6.4  | ns    | V <sub>I</sub> = 7V for t <sub>PLZ</sub><br>V <sub>I</sub> = OPEN for t <sub>PHZ</sub> | Figures 1, 2  |

**Note 6:** This parameter is guaranteed by design but is not tested. The bus switch contributes no propagation delay other than the RC delay of the typical On Resistance of the switch and the 50pF load capacitance, when driven by an ideal voltage source (zero output impedance).

## Capacitance (Note 7)

| Symbol           | Parameter                     | Typ | Max | Units | Conditions                               |
|------------------|-------------------------------|-----|-----|-------|--|
| C <sub>IN</sub>  | Control Pin Input Capacitance | 3   |     | pF    | V <sub>CC</sub> = 5.0V                   |
| C <sub>I/O</sub> | Input/Output Capacitance      | 6   |     | pF    | V <sub>CC</sub> , $\overline{OE}$ = 5.0V |

**Note 7:** T<sub>A</sub> = +25°C, f = 1 MHz. Capacitance is characterized but not tested.

## AC Loading and Waveforms

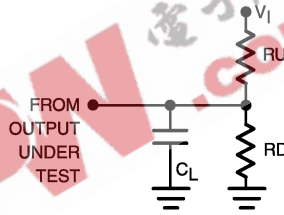

**Note:** Input driven by 50 Ω source terminated in 50 Ω

**Note:** C<sub>L</sub> includes load and stray capacitance

**Note:** Input PRR = 1.0 MHz, t<sub>W</sub> = 500ns

FIGURE 1. AC Test Circuit

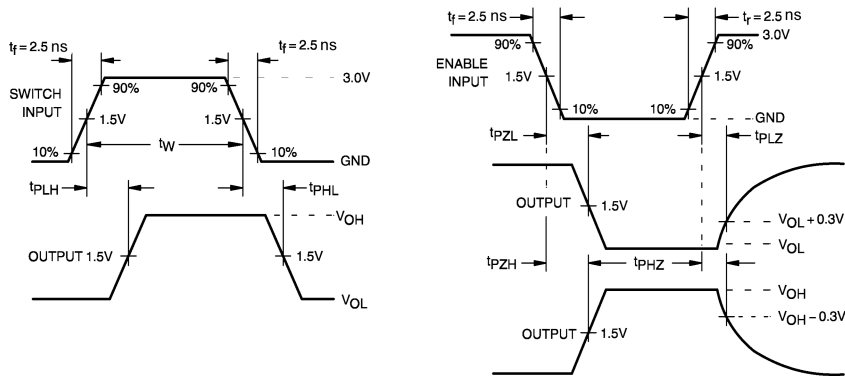

FIGURE 2. AC Waveforms

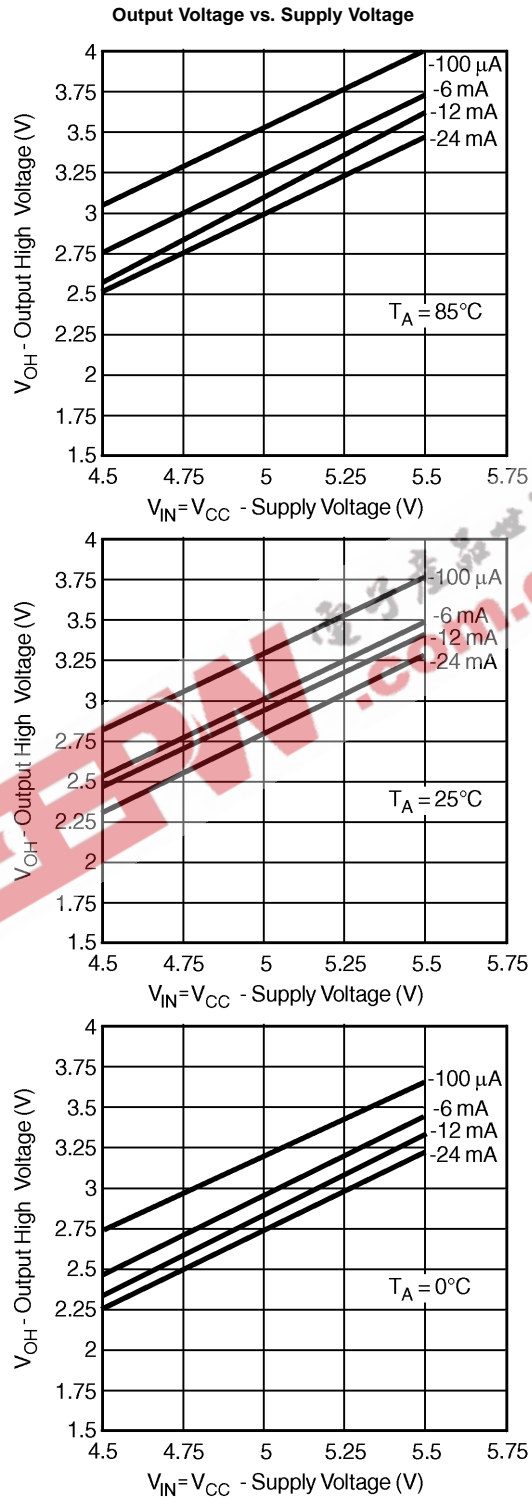
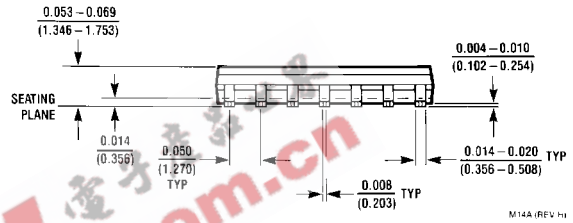
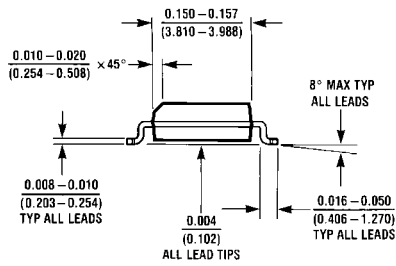
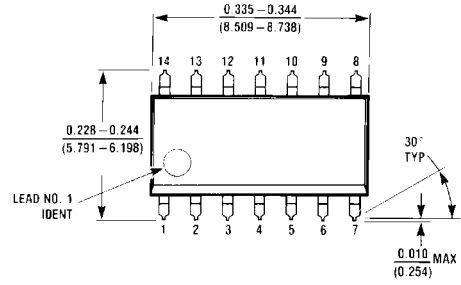
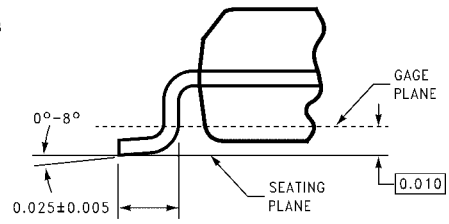
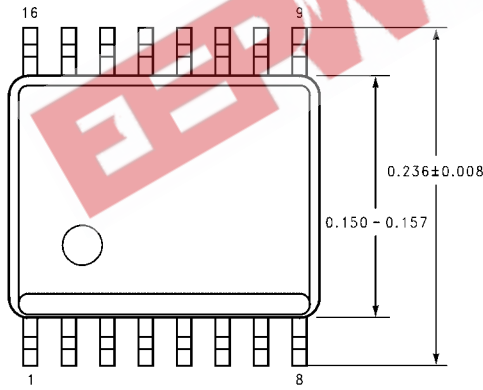

FIGURE 3.

**Physical Dimensions** inches (millimeters) unless otherwise noted



**14-Lead Small Outline Integrated Circuit (SOIC), JEDEC MS-012, 0.150" Narrow Package Number M14A**



**DETAIL A**  
TYPICAL, SCALE: 40%

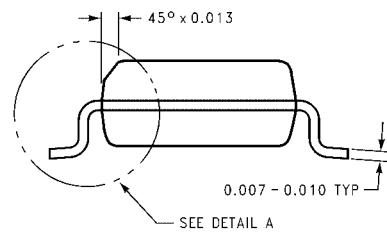
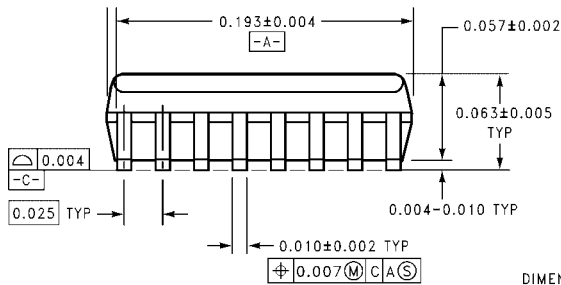

DIMENSIONS ARE IN INCHES

**16-Lead Quarter Size Outline Package (QSOP), JEDEC MO-137, 0.150" Wide Package Number MQA16**

MQA16 (REV. A)

**Physical Dimensions** inches (millimeters) unless otherwise noted (Continued)

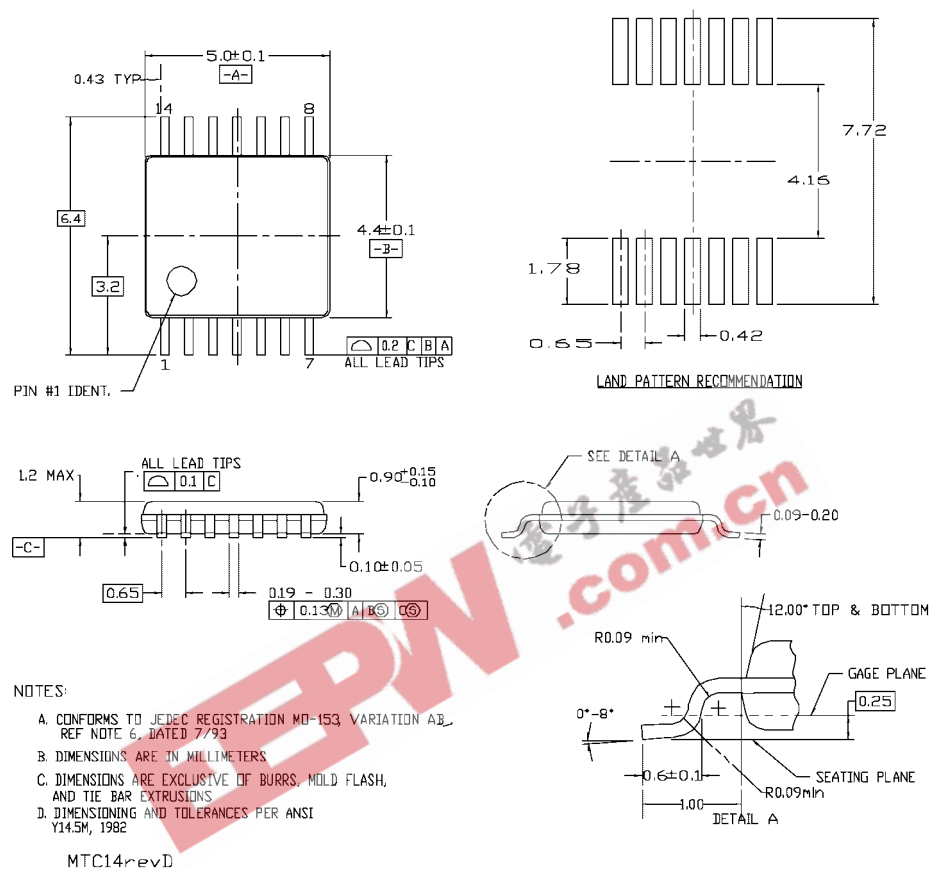

**14-Lead Thin Shrink Small Outline Package (TSSOP), JEDEC MO-153, 4.4mm Wide Package Number MTC14**

**Technology Description**

The Fairchild Switch family derives from and embodies Fairchild's proven switch technology used for several years in its 74LVX3L384 (FST3384) bus switch product.

Fairchild does not assume any responsibility for use of any circuitry described, no circuit patent licenses are implied and Fairchild reserves the right at any time without notice to change said circuitry and specifications.

**LIFE SUPPORT POLICY**

FAIRCHILD'S PRODUCTS ARE NOT AUTHORIZED FOR USE AS CRITICAL COMPONENTS IN LIFE SUPPORT DEVICES OR SYSTEMS WITHOUT THE EXPRESS WRITTEN APPROVAL OF THE PRESIDENT OF FAIRCHILD SEMICONDUCTOR CORPORATION. As used herein:

1. Life support devices or systems are devices or systems which, (a) are intended for surgical implant into the body, or (b) support or sustain life, and (c) whose failure to perform when properly used in accordance with instructions for use provided in the labeling, can be reasonably expected to result in a significant injury to the user.
2. A critical component in any component of a life support device or system whose failure to perform can be reasonably expected to cause the failure of the life support device or system, or to affect its safety or effectiveness.

[www.fairchildsemi.com](http://www.fairchildsemi.com)