

## Resonator

# Piezoelectric Resonator (4 to 16 MHz)

## FAR Family (C4 series P/Q type) For Motor Application

### ■ DESCRIPTION

Fujitsu resonators C4 series (P/Q type) feature single crystals with a high electro-mechanical coefficient (LiNbO<sub>3</sub>: lithium niobate), the result is very compact packaging.

C4 series (P/Q type) with built-in capacitors for exclusive use in microcomputer clocks, and this series is chip type device for surface-mount and suitable for motor application due to its high reliability package.

### ■ FEATURES

- Wide frequency range in 4 to 16 MHz
- Suitable for microcomputer clock
- PCT (121 °C, 2 atms, 96 hours) is guaranteed for Motor application.
- Emboss-typed pack for automatic mounting
- Superior shock and vibration resistance, preventing damage during automatic mounting

### ■ PACKAGE

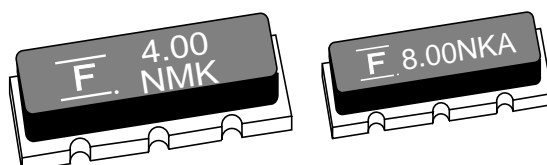

# FAR Family (C4 series P/Q type)

## STANDARD CHARACTERISTICS

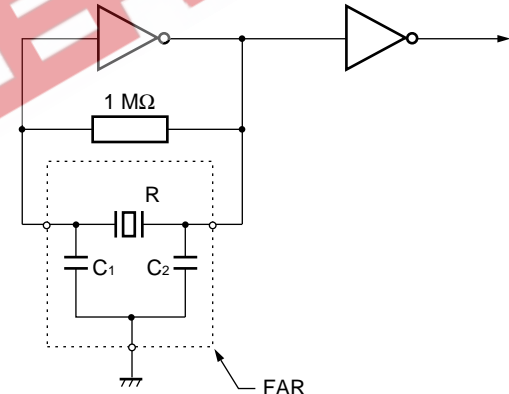
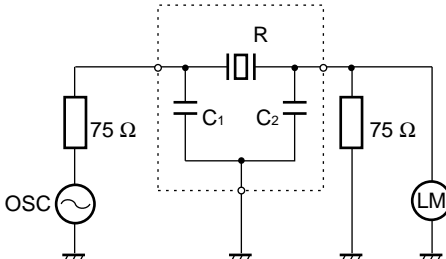
Parameter	Series	C4 series (P/Q type)	Remarks
Material		Lithium Niobate (LiNbO <sub>3</sub> )	
Frequency		4 to 16 MHz	
Standard frequency		See "Standard Frequency."	
Initial frequency deviation		±0.5% (M)	The ±0.3% (K) version can also be produced.
Temperature characteristic (-40°C to +105°C)		± <sup>0.9</sup> / <sub>1.0</sub> % (M)	Reference temperature: +25°C
Capacity of built-in capacitor		20±8 pF (standard)	10±4 pF, 30±8 pF are also available. Capacity is specified by Fujitsu, considering matching data with applied IC (mainly microcomputer).
Aging stability		Within ±0.1%	For ten years at room temperature
PCT		96 hours guaranteed	Unstaturated PCT: 121°C 2 atmospheric pressures
Operating temperature		-40°C to +105°C	
Storage temperature		-55°C to +105°C	
Standard measuring circuit		<ul style="list-style-type: none"> <li>Resonant frequency</li> </ul>  <ul style="list-style-type: none"> <li>Serial resonant resistance</li> </ul> 	<p>4 MHz to 10 MHz IC: MB84069B×2</p> <p>10 MHz to 16.0 MHz IC: MC74HC04×2</p> <ul style="list-style-type: none"> <li>Vcc: 5 V DC</li> <li>R: Resonator</li> <li>C1, C2: Loading capacitors (built-in)</li> </ul> <p>R: Resonator Measuring instrument: Network analyzer</p>

# FAR Family (C4 series P/Q type)

## ■ STANDARD FREQUENCY

Standard frequency (kHz)	Package size	Resonant resistance
4,000	P	150 Ω max. (Symbol: 01)
8,000 10,000 12,000 16,000	Q	75 Ω max. (Symbol: 02)

- Notes:**
- Fujitsu can also develop applicable device in addition to standard devices if it's oscillation frequency is from 4 to 16 MHz.
  - Resonant resistance of the part other than standard, Fujitsu should specify its resonant resistance according to applied frequency. (See “• Frequency and standard resonant resistance.”)

- Frequency and standard resonant resistance

Frequency	Standard resonant resistance
4.00 to 5.99 MHz	150 Ω max. (Symbol: 1)
6.00 to 16.00 MHz	75 Ω max. (Symbol: 2)

## ■ NOTES ON USE

- Handle carefully
- Solder under the following conditions.  
5 seconds max. at 230°C (PCB)  
Recommended preheating is 150°C for one minute in order not to apply extreme heat to the resonator.
- Avoid extreme fluctuations in temperature.
- There is no specific direction in resonator mounting.
- Oscillation data should be examined when used in oscillation circuit with microcomputer or other ICs.
- This is for reflow solder, not for flow solder.

# FAR Family (C4 series P/Q type)

## ■ PART NUMBERING SYSTEM

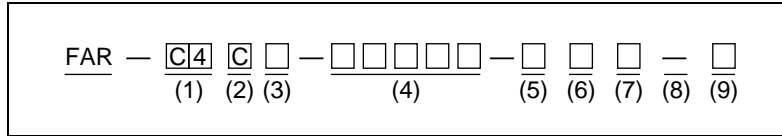

### (1) Series

Series	Single crystal	Capacitor
C4	LiNbO <sub>3</sub>	With built-in capacitor

### (2) Package Type

Specification	Type
C	CHIP

### (3) Package Size

Specification	Size
P	Large (4.0 to 5.9 MHz)
Q	Small (6.0 to 16.0 MHz)

### (4) Frequency

(Example) Unit: kHz (Specify in five digits.)

Frequency	Specification
8.000 MHz	08000

See “■ Standard Frequency”.

### (5) Initial Frequency Deviation

Specification	Deviation
K	±0.3%
M	±0.5%

### (6) Built-in Capacitor

Specification	Capacitance
0	20±8 pF
1	10±4 pF
2	30±8 pF

## FAR Family (C4 series P/Q type)

### (7) Resonant Resistance

Specification	Resonant resistance
1	150 $\Omega$
2	75 $\Omega$

### (8) User-specific Special Symbols

Specification	Description
Name	No specifications, no taping specification
—	No specifications, with taping specification
A to Z	Serial number for custom design

### (9) Taping Specification

Specification	Description
R	16 mm wide emboss tape (3,000 pcs)

EEPW 电子产业网 .com.cn

# FAR Family (C4 series P/Q type)

## MARKING

The diagram shows a rectangular marking area containing the text "F 8.00 NMK".

- Fujitsu logo:** Points to the letter "F".
- Frequency (MHz):** Points to the number "8.00".
- Material symbol:** Points to the letters "NMK". Below this label, it specifies "N: LiNbO<sub>3</sub>".
- Lot No. (Date of manufacture, conforms to EIAJ):** Points to the letters "NMK".
- Initial frequency deviation:** Points to the letters "NMK".

**Note:** The marking color varies with the capacitance of the built-in capacitor.

Capacitance	Marking color
10 pF	Yellow
20 pF	White
30 pF	Gray

Data code (EIAJ standard) is specified as follows in four-year cycle.

Year	Month	Symbol	Year	Month	Symbol	Year	Month	Symbol	Year	Month	Symbol
1997 2001	1	A	1998 2002	1	N	1999 2003	1	a	2000 2004	1	n
	2	B		2	P		2	b		2	o
	3	C		3	Q		3	c		3	q
	4	D		4	R		4	d		4	r
	5	F		5	S		5	e		5	s
	6	G		6	T		6	f		6	t
	7	H		7	U		7	g		7	u
	8	I		8	V		8	h		8	v
	9	J		9	W		9	j		9	w
	10	K		10	X		10	k		10	x
	11	L		11	Y		11	l		11	y
	12	M		12	Z		12	m		12	z

# FAR Family (C4 series P/Q type)

## PIN ASSIGNMENT

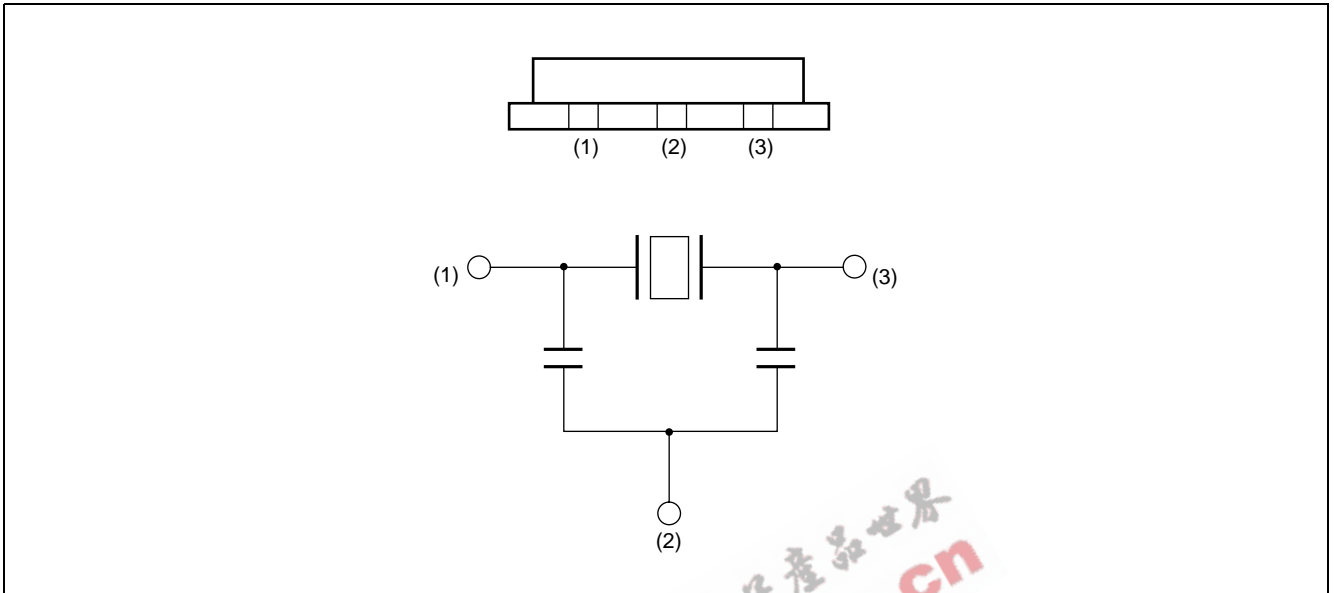

## DIMENSIONS

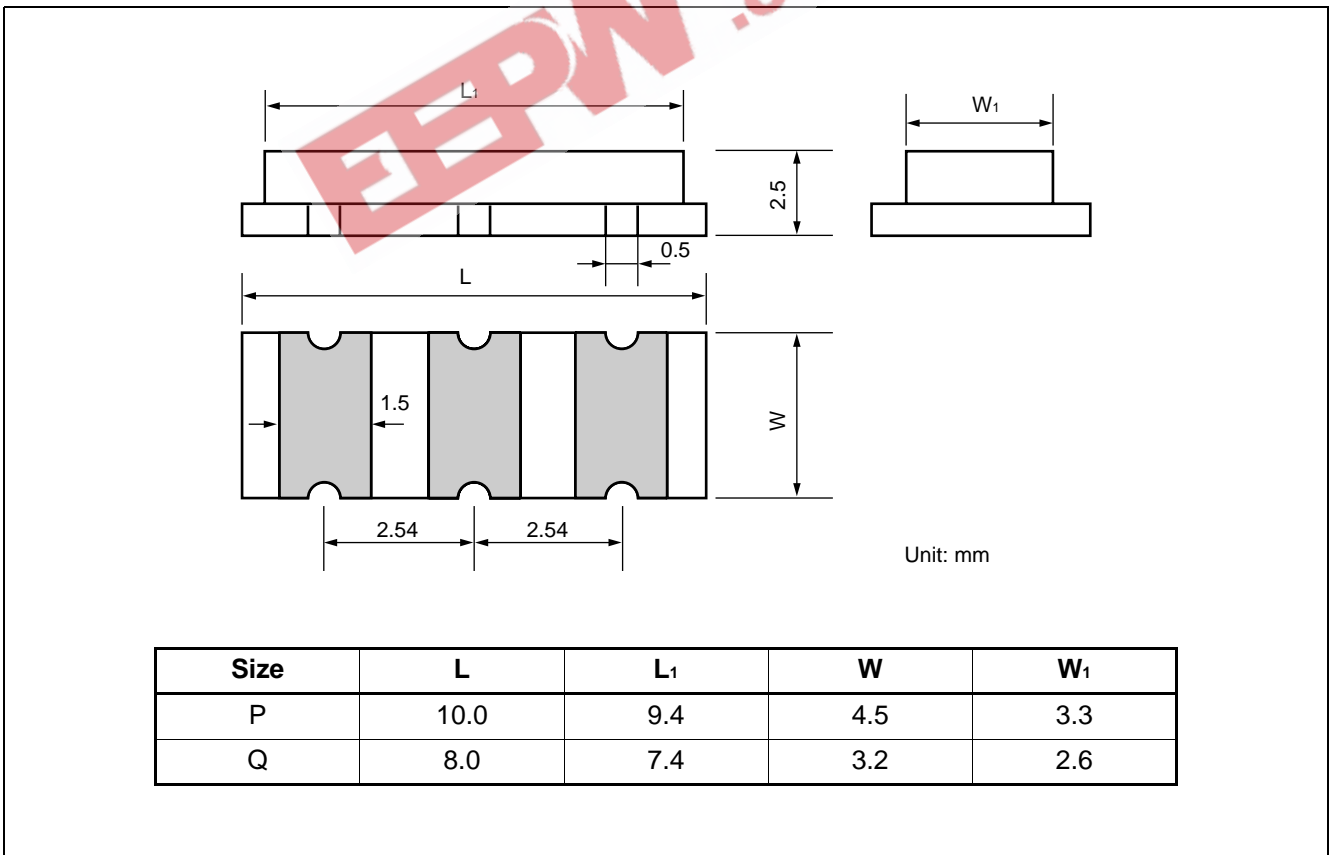

# FAR Family (C4 series P/Q type)

## ■ TAPING FORM AND DIMENSIONS

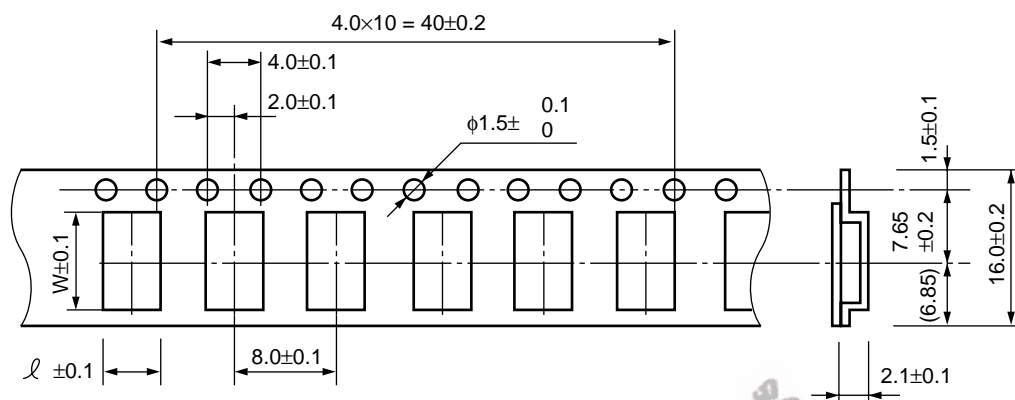

Package size	$l$	$W$	$t$
P	5.0	10.5	3.0
Q	3.7	8.5	2.8

Reel form

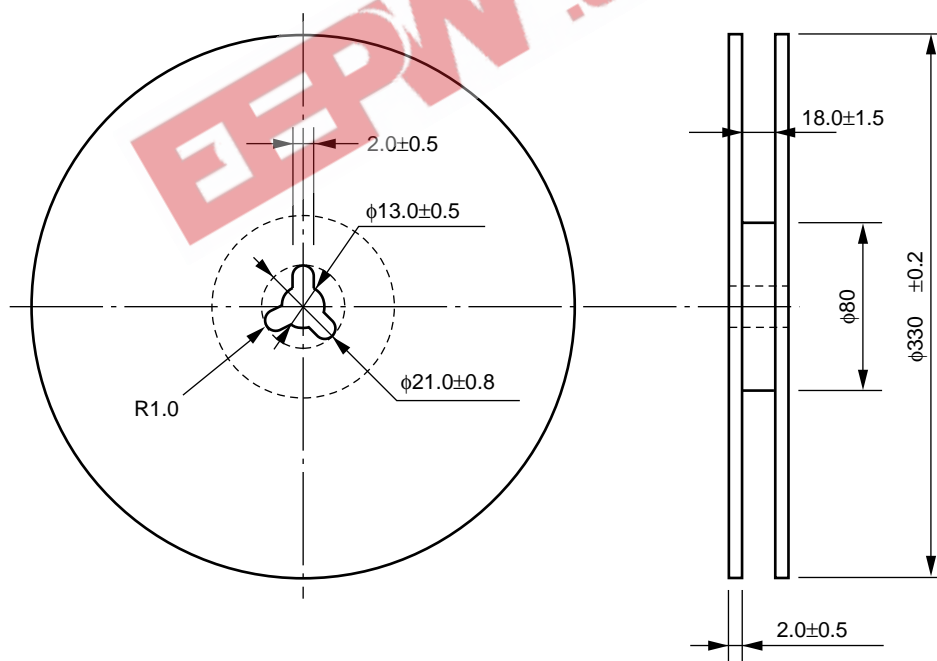

• Pack quantity

Package size	Quantity
P, Q	3,000

Unit: mm



# FAR Family (C4 series P/Q type)

## FUJITSU LIMITED

*For further information please contact:*

### **Japan**

FUJITSU LIMITED  
Corporate Global Business Support Division  
Electronic Devices  
KAWASAKI PLANT, 4-1-1, Kamikodanaka  
Nakahara-ku, Kawasaki-shi  
Kanagawa 211-88, Japan  
Tel: (044) 754-3763  
Fax: (044) 754-3329

### **North and South America**

FUJITSU MICROELECTRONICS, INC.  
Semiconductor Division  
3545 North First Street  
San Jose, CA 95134-1804, U.S.A.  
Tel: (408) 922-9000  
Fax: (408) 432-9044/9045

### **Europe**

FUJITSU MIKROELEKTRONIK GmbH  
Am Siebenstein 6-10  
63303 Dreieich-Buchsschlag  
Germany  
Tel: (06103) 690-0  
Fax: (06103) 690-122

### **Asia Pacific**

FUJITSU MICROELECTRONICS ASIA PTE. LIMITED  
#05-08, 151 Lorong Chuan  
New Tech Park  
Singapore 556741  
Tel: (65) 281-0770  
Fax: (65) 281-0220

All Rights Reserved.

The contents of this document are subject to change without notice. Customers are advised to consult with FUJITSU sales representatives before ordering.

The information and circuit diagrams in this document presented as examples of semiconductor device applications, and are not intended to be incorporated in devices for actual use. Also, FUJITSU is unable to assume responsibility for infringement of any patent rights or other rights of third parties arising from the use of this information or circuit diagrams.

FUJITSU semiconductor devices are intended for use in standard applications (computers, office automation and other office equipment, industrial, communications, and measurement equipment, personal or household devices, etc.).

#### **CAUTION:**

Customers considering the use of our products in special applications where failure or abnormal operation may directly affect human lives or cause physical injury or property damage, or where extremely high levels of reliability are demanded (such as aerospace systems, atomic energy controls, sea floor repeaters, vehicle operating controls, medical devices for life support, etc.) are requested to consult with FUJITSU sales representatives before such use. The company will not be responsible for damages arising from such use without prior approval.

Any semiconductor devices have inherently a certain rate of failure. You must protect against injury, damage or loss from such failures by incorporating safety design measures into your facility and equipment such as redundancy, fire protection, and prevention of over-current levels and other abnormal operating conditions.

If any products described in this document represent goods or technologies subject to certain restrictions on export under the Foreign Exchange and Foreign Trade Control Law of Japan, the prior authorization by Japanese government should be required for export of those products from Japan.