

# C&K P Series 4 Tumbler Snap-in Switchlocks



## Features/Benefits

- Snap-in mounting
- Multi-pole and multi-position
- Positive detent

## Typical Applications

- Computers
- Business machines
- Communication equipment



## Specifications

CONTACT RATING: Q contact material: 4 AMPS @ 125 V AC; 1 AMP @ 250 V AC (UL/CSA). See page M-20 for additional ratings.

ELECTRICAL LIFE: 10,000 make-and-break cycles at full load.

CONTACT RESISTANCE: Below 10 m Ω typ. initial @ 2-4 V DC, 100 mA, for both silver and gold plated contacts.

INSULATION RESISTANCE: 10<sup>9</sup> Ω min.

DIELECTRIC STRENGTH: 1,000 Vrms min. @ sea level.

INDEXING: 45° or 90°, 2-3 positions.

## Materials

SWITCH HOUSING & LOCK: One piece construction, 6/6 Nylon (UL 94V-2), black  
4 disc tumbler mechanism.

KEYS: One nickel plated brass key and one key with insert molded plastic head.

TUMBLERS: Disc tumblers, brass.

CONTACTS & TERMINALS: Q contact material: Copper, silver plated. See page M-20 for additional contact materials.

**NOTE:** Any models supplied with Q or B contact material are RoHS compliant. For the latest information regarding RoHS compliance, please go to: [www.ittcannon.com/rohs](http://www.ittcannon.com/rohs).

**NOTE:** Specifications and materials listed above are for switchlocks with standard options. For information on specific and custom switchlocks, consult Customer Service Center.

## Build-A-Switch

To order, simply select desired option from each category and place in the appropriate box. Available options are shown and described on pages M-19 through M-21. For additional options not shown in catalog, consult Customer Service Center.

### Switch and Lock Function

- P10113** SP, 90° Index, keypull pos. 1
- P20113** DP, 90° Index, keypull pos. 1
- P100AF** SP, 45° Index, keypull pos. 1, 2 & 3
- P200AF** DP, 45° Index, keypull pos. 1, 2 & 3
- P1011U** SP, 90° Index, keypull pos. 1 & 2

### Keying

- 2** Two nickel plated brass keys
- T** One nickel plated brass key with insert molded plastic square head and one nickel plated brass key

### Lock Type

- C** 4 Tumbler lock with detent

### Lock Finish

- M** Plastic lock with matte finish

### Terminations

- 03** Solder lug
- WC** Wire lead

### Contact Material

- Q** Silver
- G** Gold over silver

### Lock Color

- 2** Black

### Key Color

- 2** Black
- NONE** Nickel plated brass

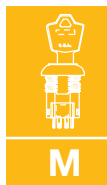

Switchlock



Dimensions are shown: Inch (mm)  
Specifications and dimensions subject to change



# C&K P Series 4 Tumbler Snap-in Switchlocks

## SWITCH AND LOCK FUNCTION

NO. POLES	MODEL NO.	CONNECTED TERMINALS			KEY PULL POSITIONS	LOCK CONFIGURATION	INDEXING
		POS. 1	POS. 2	POS. 3			
SP DP	<b>P10113</b> <b>P20113</b>	8-1 8-1, 4-5	1-3 1-3, 5-7		Position 1		90°
DP	<b>P100AF</b> <b>P200AF</b>	8-1 8-1, 4-5	1-2 1-2, 5-6	2-3 2-3, 6-7	Positions 1, 2 & 3		45°
SP	<b>P1011U</b>	8-1	1-3		Positions 1 & 2		90°

### TERMINAL NUMBERS

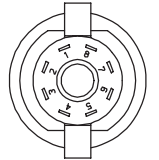

Terminal numbers molded on housing.

All models with all options when ordered with 'G' or 'Q' contact material.

### LEGEND

- = Detent Positions (45° or 90°)
- ⊙ = Key pull possible in these positions.
- ⦿ = Stop Positions

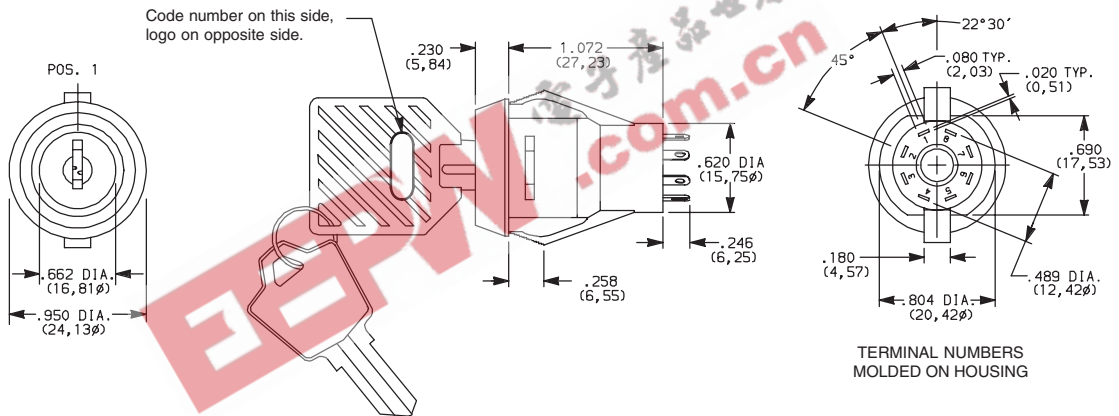

Part number shown: P100AFTCM03Q22

## KEYING

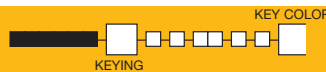

OPTION CODE	KEYING OPTIONS	CODE NO. ON KEY	CODE NO. ON LOCK
<b>2</b>	2 NICKEL PLATED BRASS KEYS	YES	NO
<b>T</b>	1 NICKEL PLATED BRASS KEY WITH PLASTIC INSERT MOLDED SQUARE HEAD & 1 NICKEL PLATED BRASS KEY	YES	NO

OPTION CODE	KEY COLOR
<b>2</b>	BLACK
<b>NONE</b>	NICKEL PLATED BRASS

### NICKEL PLATED BRASS KEY

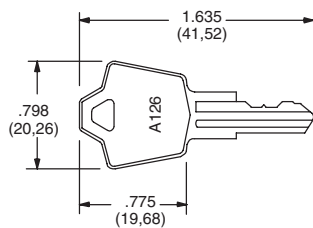

Key part number: 115140126

### NICKEL PLATED BRASS KEY WITH PLASTIC INSERT MOLDED SQUARE HEAD

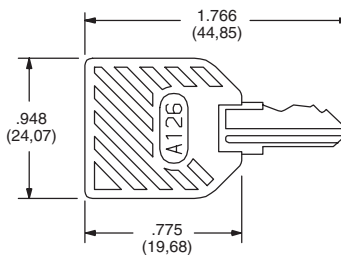

Key part number: 11599112602

**NOTE:** Key head shape subject to change without notice.

**NOTE:** All orders keyed alike with code number on key, standard. For more than one key code, replacement keys or other special features, consult Customer Service Center.



Dimensions are shown: Inch (mm)  
Specifications and dimensions subject to change

# C&K P Series 4 Tumbler Snap-in Switchlocks

## LOCK TYPE

**C** 4 TUMBLER LOCK WITH DETENT

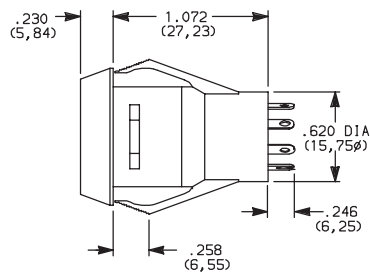

OPTION CODE	LOCK COLOR
<b>2</b>	BLACK

## LOCK FINISH

**M** PLASTIC LOCK WITH MATTE FINISH

## TERMINATIONS

**03** SOLDER LUG

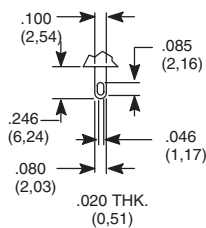

**WC** WIRE LEAD

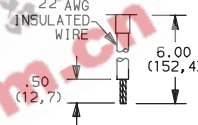

Black wire standard, other colors, gages and lengths available, consult Customer Service Center. UL style 1015.

### PC MOUNTING

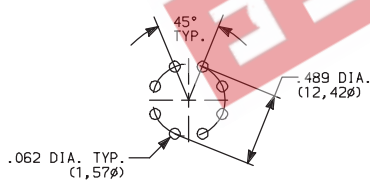

### PANEL MOUNTING

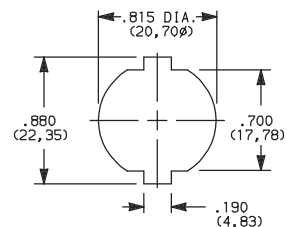

Panel Thickness: .100-.200 (2,54-5,08)

## CONTACT MATERIAL

OPTION CODE	RoHS COMPLIANT*	RoHS COMPATIBLE*	CONTACT AND TERMINAL MATERIAL	RATING	
<b>Q</b>	YES	YES	SILVER <sup>2</sup>	POWER	4 AMPS @ 125 V AC; 1 AMP @ 250 V AC (UL/CSA)
<b>G</b>	YES	YES	GOLD OVER SILVER <sup>3</sup>	LOW LEVEL/DRY CIRCUIT OR POWER	0.4 VA MAX. @ 20 V AC or DC MAX. or 4 AMPS @ 125 V AC; 1 AMP @ 250 V AC (UL/CSA)

\* Note: See Technical Data section of this catalog for RoHS compliant and compatible definitions and specifications.

<sup>2</sup> CONTACTS & TERMINALS: Copper, silver plated (standard with all termination options).

<sup>3</sup> CONTACTS & TERMINALS: Copper, with gold plate over silver plate.

All models with all options when ordered with 'G' or 'Q' contact material.



**M**

Switchlock



Dimensions are shown: Inch (mm)  
Specifications and dimensions subject to change

# C&K P Series 4 Tumbler Snap-in Switchlocks

## AVAILABLE HARDWARE



Key Code: A126  
**PART NO. (ONE KEY)**  
**115140126**  
**Material:** Brass  
Finish: Nickel plate



Key Code: A126  
**PART NO. (ONE KEY)**  
**11599112602** BLACK  
**Material:** Brass  
Finish: Nickel plate  
6/6 Nylon insert molded head

EEPW 电子产品世界  
.com.cn