

C&K P Series 4 Tumbler Snap-in Switchlocks



Features/Benefits

- Snap-in mounting
- Multi-pole and multi-position
- Positive detent

Typical Applications

- Computers
- Business machines
- Communication equipment



Specifications

CONTACT RATING: Q contact material: 4 AMPS @ 125 V AC; 1 AMP @ 250 V AC (UL/CSA). See page M-20 for additional ratings.

ELECTRICAL LIFE: 10,000 make-and-break cycles at full load.

CONTACT RESISTANCE: Below 10 m Ω typ. initial @ 2-4 V DC, 100 mA, for both silver and gold plated contacts.

INSULATION RESISTANCE: 10⁹ Ω min.

DIELECTRIC STRENGTH: 1,000 Vrms min. @ sea level.

INDEXING: 45° or 90°, 2-3 positions.

Materials

SWITCH HOUSING & LOCK: One piece construction, 6/6 Nylon (UL 94V-2), black
4 disc tumbler mechanism.

KEYS: One nickel plated brass key and one key with insert molded plastic head.

TUMBLERS: Disc tumblers, brass.

CONTACTS & TERMINALS: Q contact material: Copper, silver plated. See page M-20 for additional contact materials.

NOTE: Any models supplied with Q or B contact material are RoHS compliant. For the latest information regarding RoHS compliance, please go to: www.ittcannon.com/rohs.

NOTE: Specifications and materials listed above are for switchlocks with standard options. For information on specific and custom switchlocks, consult Customer Service Center.

Build-A-Switch

To order, simply select desired option from each category and place in the appropriate box. Available options are shown and described on pages M-19 through M-21. For additional options not shown in catalog, consult Customer Service Center.

Switch and Lock Function

- P10113** SP, 90° Index, keypull pos. 1
- P20113** DP, 90° Index, keypull pos. 1
- P100AF** SP, 45° Index, keypull pos. 1, 2 & 3
- P200AF** DP, 45° Index, keypull pos. 1, 2 & 3
- P1011U** SP, 90° Index, keypull pos. 1 & 2

Keying

- 2** Two nickel plated brass keys
- T** One nickel plated brass key with insert molded plastic square head and one nickel plated brass key

Lock Type

- C** 4 Tumbler lock with detent

Lock Finish

- M** Plastic lock with matte finish

Terminations

- 03** Solder lug
- WC** Wire lead

Contact Material

- Q** Silver
- G** Gold over silver

Lock Color

- 2** Black

Key Color

- 2** Black
- NONE** Nickel plated brass

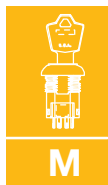

Switchlock



Dimensions are shown: Inch (mm)
Specifications and dimensions subject to change

C&K P Series 4 Tumbler Snap-in Switchlocks

SWITCH AND LOCK FUNCTION

NO. POLES	MODEL NO.	CONNECTED TERMINALS			KEY PULL POSITIONS	LOCK CONFIGURATION	INDEXING
		POS. 1	POS. 2	POS. 3			
SP DP	P10113 P20113	8-1 8-1, 4-5	1-3 1-3, 5-7		Position 1		90°
DP	P100AF P200AF	8-1 8-1, 4-5	1-2 1-2, 5-6	2-3 2-3, 6-7	Positions 1, 2 & 3		45°
SP	P1011U	8-1	1-3		Positions 1 & 2		90°

TERMINAL NUMBERS

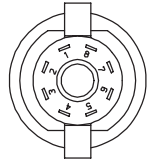

Terminal numbers molded on housing.

All models with all options when ordered with 'G' or 'Q' contact material.

LEGEND

- = Detent Positions (45° or 90°)
- ⊙ = Key pull possible in these positions.
- ⦿ = Stop Positions

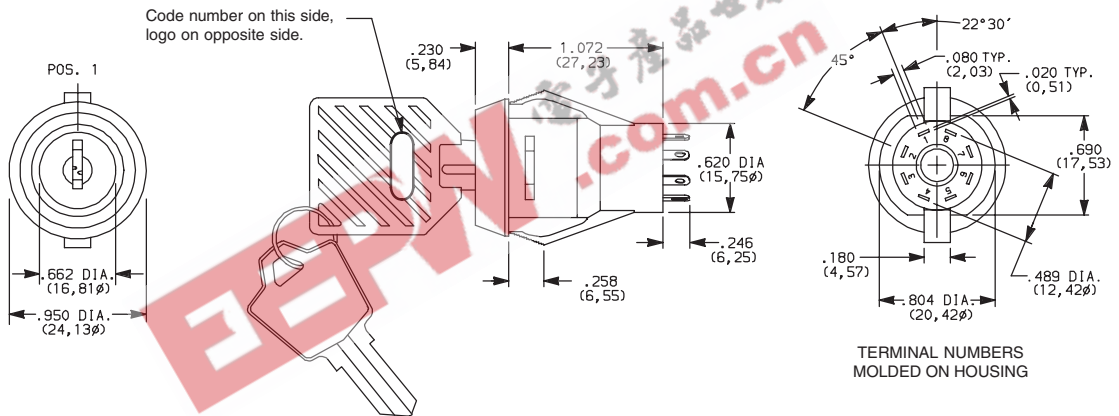

Part number shown: P100AFTCM03Q22

KEYING

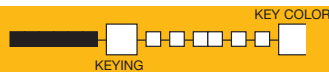

OPTION CODE	KEYING OPTIONS	CODE NO. ON KEY	CODE NO. ON LOCK
2	2 NICKEL PLATED BRASS KEYS	YES	NO
T	1 NICKEL PLATED BRASS KEY WITH PLASTIC INSERT MOLDED SQUARE HEAD & 1 NICKEL PLATED BRASS KEY	YES	NO

OPTION CODE	KEY COLOR
2	BLACK
NONE	NICKEL PLATED BRASS

NICKEL PLATED BRASS KEY

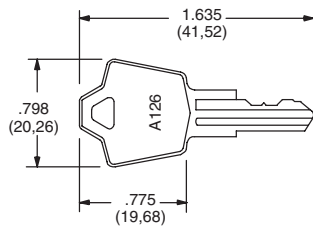

Key part number: 115140126

NICKEL PLATED BRASS KEY WITH PLASTIC INSERT MOLDED SQUARE HEAD

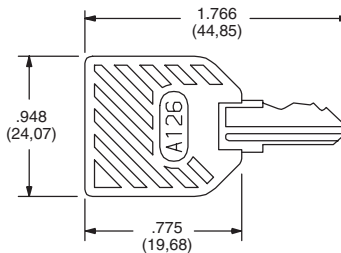

Key part number: 11599112602

NOTE: Key head shape subject to change without notice.

NOTE: All orders keyed alike with code number on key, standard. For more than one key code, replacement keys or other special features, consult Customer Service Center.



Dimensions are shown: Inch (mm)
Specifications and dimensions subject to change

C&K P Series 4 Tumbler Snap-in Switchlocks

LOCK TYPE

C 4 TUMBLER LOCK WITH DETENT

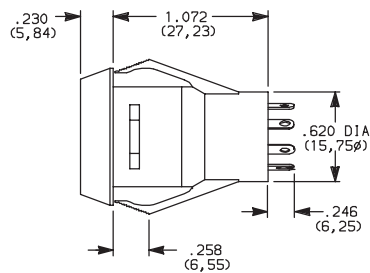

OPTION CODE	LOCK COLOR
2	BLACK

LOCK FINISH

M PLASTIC LOCK WITH MATTE FINISH

TERMINATIONS

03 SOLDER LUG

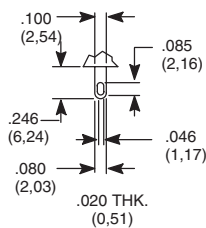

WC WIRE LEAD

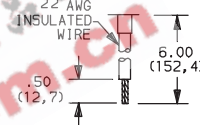

Black wire standard, other colors, gages and lengths available, consult Customer Service Center. UL style 1015.

PC MOUNTING

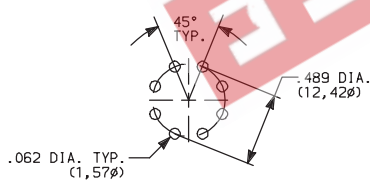

PANEL MOUNTING

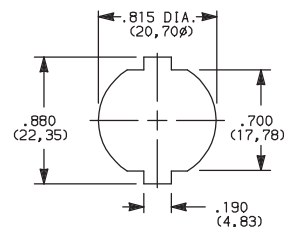

Panel Thickness: .100-.200 (2,54-5,08)

CONTACT MATERIAL

OPTION CODE	RoHS COMPLIANT*	RoHS COMPATIBLE*	CONTACT AND TERMINAL MATERIAL	RATING	
				POWER	4 AMPS @ 125 V AC; 1 AMP @ 250 V AC (UL/CSA)
Q	YES	YES	SILVER ²	POWER	4 AMPS @ 125 V AC; 1 AMP @ 250 V AC (UL/CSA)
G	YES	YES	GOLD OVER SILVER ³	LOW LEVEL/DRY CIRCUIT OR POWER	0.4 VA MAX. @ 20 V AC or DC MAX. or 4 AMPS @ 125 V AC; 1 AMP @ 250 V AC (UL/CSA)

* Note: See Technical Data section of this catalog for RoHS compliant and compatible definitions and specifications.

² CONTACTS & TERMINALS: Copper, silver plated (standard with all termination options).

³ CONTACTS & TERMINALS: Copper, with gold plate over silver plate.

All models with all options when ordered with 'G' or 'Q' contact material.



M

Switchlock



Dimensions are shown: Inch (mm)
Specifications and dimensions subject to change

C&K P Series 4 Tumbler Snap-in Switchlocks

AVAILABLE HARDWARE



Key Code: A126
PART NO. (ONE KEY)
115140126
Material: Brass
Finish: Nickel plate



Key Code: A126
PART NO. (ONE KEY)
11599112602 BLACK
Material: Brass
Finish: Nickel plate
6/6 Nylon insert molded head

EEPW 电子产品世界 .com.cn