

Technical Data Sheet

5 mm Round Warm White LED (T-13/4)

334-15/X2C1-1UWB

Features

- Popular T-13/4 colorless 5mm package.
- High luminous power.
- Typical chromaticity coordinates $x=0.40$, $y=0.39$ according to CIE1931.
- Bulk, available taped on reel.
- ESD-withstand voltage: up to 4KV
- The product itself will remain within RoHS compliant version .



Descriptions

- The series is designed for application required high luminous intensity.
- The phosphor filled in the reflector converts the blue emission of InGaN chip to ideal white.

Applications

- Outdoor Displays
- Optical Indicators
- Backlighting
- Marker Lights

Device Selection Guide

PART NO.	Chip		Lens Color
	Material	Emitted Color	
334-15/X2C1-1UWB	InGaN	White	Water Clear

Technical Data Sheet

5 mm Round Warm White LED (T-13/4)

334-15/X2C1-1UWB

Package Dimensions

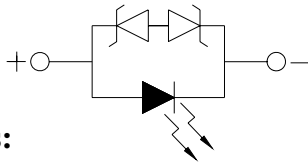
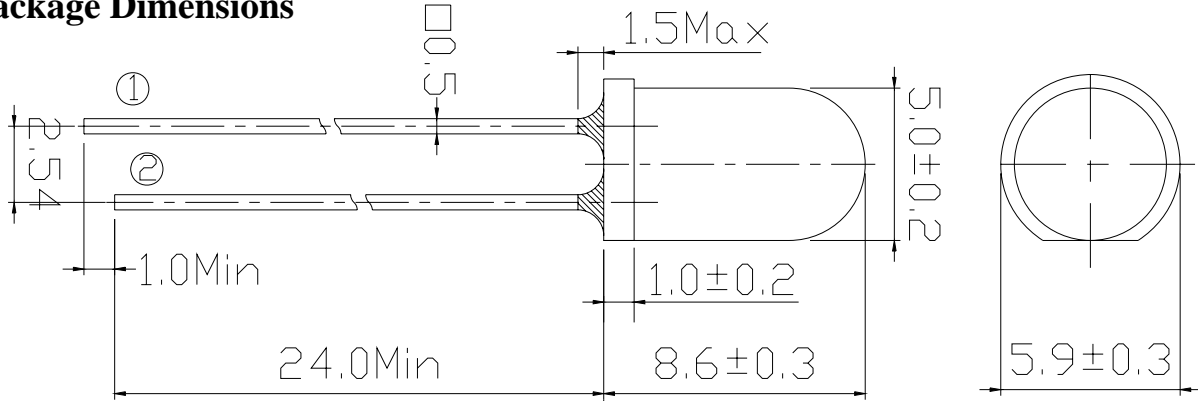

① Anode
② Cathode

Notes:

1. All dimensions are in millimeters, and tolerance is 0.25mm except being specified.
2. Lead spacing is measured where the lead emerges from the package.
3. Protruded resin under flange is 1.5mm Max. LED.

Absolute Maximum Ratings (Ta=25°C)

Parameter	Symbol	Rating	Unit
Continuous Forward Current	I_F	30	mA
Peak Forward Current(Duty /10 @ 1KHZ)	I_{FP}	100	mA
Reverse Voltage	V_R	5	V
Operating Temperature	T_{opr}	-40 ~ +85	°C
Storage Temperature	T_{stg}	-40 ~ +100	°C
Soldering Temperature (T=5 sec)	T_{sol}	260 ± 5	°C
Power Dissipation	P_d	100	mW
Zener Reverse Current	I_Z	100	mA
Electrostatic Discharge	ESD	4K	V



Technical Data Sheet

5 mm Round Warm White LED (T-13/4)

334-15/X2C1-1UWB

Production Designation

334-15/X2C1-□ □ □ □

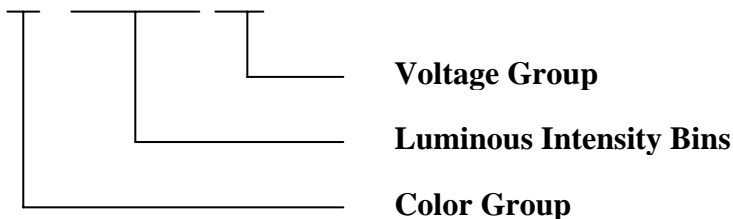

Electro-Optical Characteristics (Ta=25°C)

Parameter	Symbol	Condition	Min.	Typ.	Max.	Units
Forward Voltage	V _F	I _F =20mA	--	3.5	4.0	V
Zener Reverse Voltage	V _Z	I _Z =5mA	5.2	----	-----	V
Reverse Current	I _R	V _R =5V	--	--	50	uA
Luminous Intensity	I _V	I _F =20mA	9000		18000	mcd
Viewing Angle	2 θ 1/2	I _F =20mA	--	15	--	deg
Chromaticity Coordinates	x	I _F =20mA	--	0.40	--	
	y		--	0.39	--	



Technical Data Sheet

5 mm Round Warm White LED (T-13/4)

334-15/X2C1-1UWB

Luminous Intensity Combination (mcd at 20mA)

Rank	Min	Max
U	9000.0	11250.0
V	11250.0	14250.0
W	14250.0	18000.0

*Measurement Uncertainty of Luminous Intensity: $\pm 15\%$

Forward Voltage Combination (V at 20mA)

Group	B				
Rank	1	2	3	4	5
Min.	3.00	3.20	3.40	3.60	3.80
Max.	3.20	3.40	3.60	3.80	4.00

*Measurement Uncertainty of Forward Voltage : $\pm 0.1V$



Technical Data Sheet

5 mm Round Warm White LED (T-13/4)

334-15/X2C1-1UWB

CIE Chromaticity Diagram

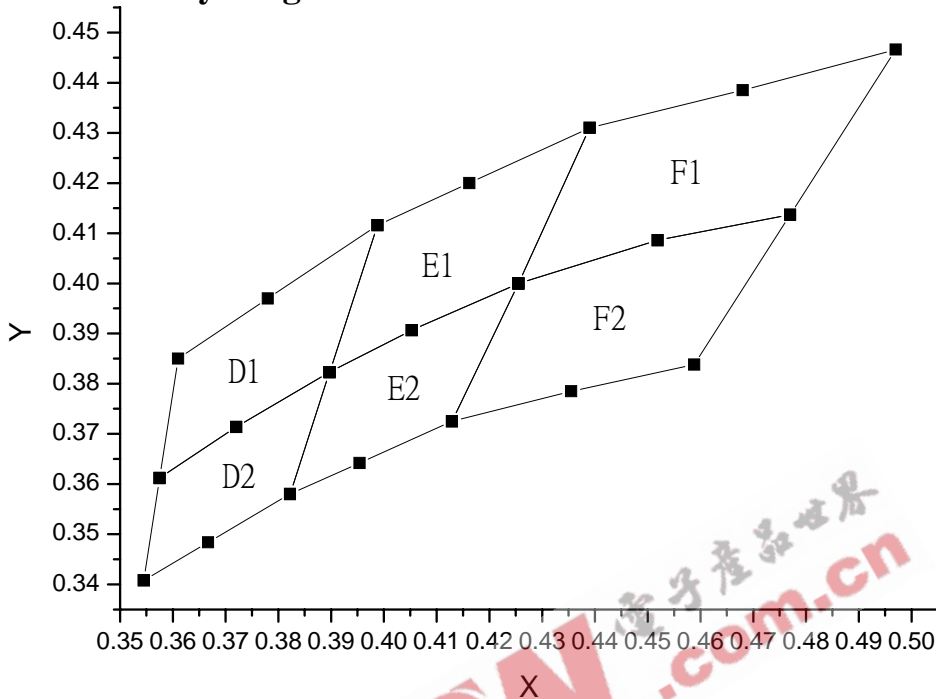

Color Ranks (IF=20mA , Ta=25°C)

Color Ranks		CIE			
D1	X	0.357	0.361	0.398	0.389
	Y	0.361	0.385	0.411	0.382
D2	X	0.354	0.357	0.389	0.382
	Y	0.340	0.361	0.382	0.358
E1	X	0.389	0.398	0.439	0.425
	Y	0.382	0.411	0.431	0.400
E2	X	0.382	0.389	0.425	0.412
	Y	0.358	0.382	0.400	0.372
F1	X	0.425	0.439	0.497	0.477
	Y	0.400	0.431	0.466	0.413
F2	X	0.412	0.425	0.477	0.458
	Y	0.372	0.400	0.413	0.383

*Measurement uncertainty of the color coordinates : ±0.01



Technical Data Sheet

5 mm Round Warm White LED (T-13/4)

334-15/X2C1-1UWB

Typical Electro-Optical Characteristics Curves

Relative Intensity vs. Wavelength

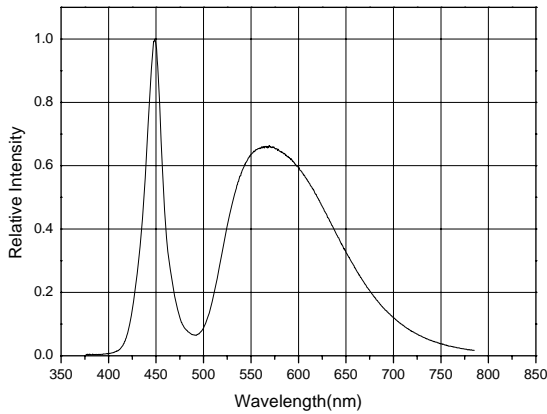

Forward Current vs. Forward Voltage

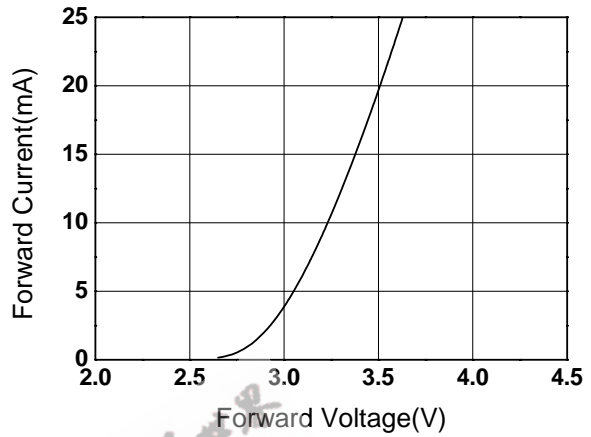

Relative Intensity vs. Forward Current

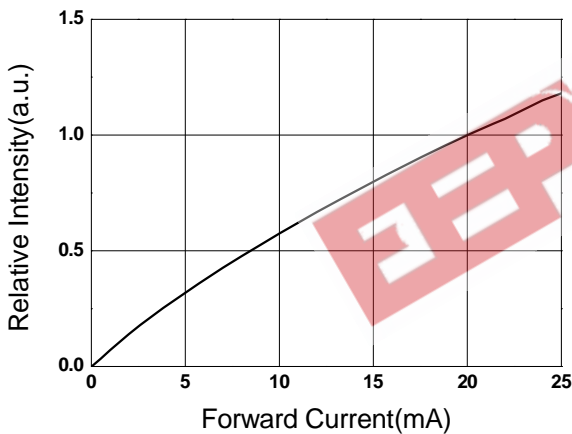

Forward Current vs. Ambient Temp.

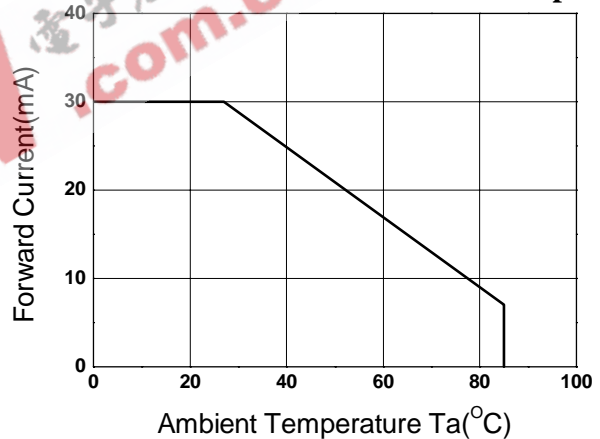

Chromaticity Coordinate vs. Forward Current

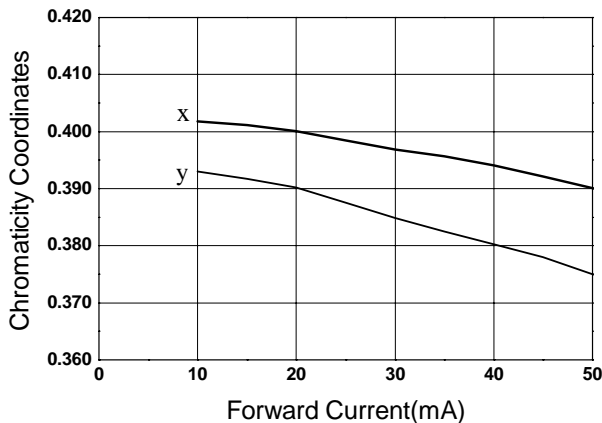

Relative Intensity vs. Angle Displacement

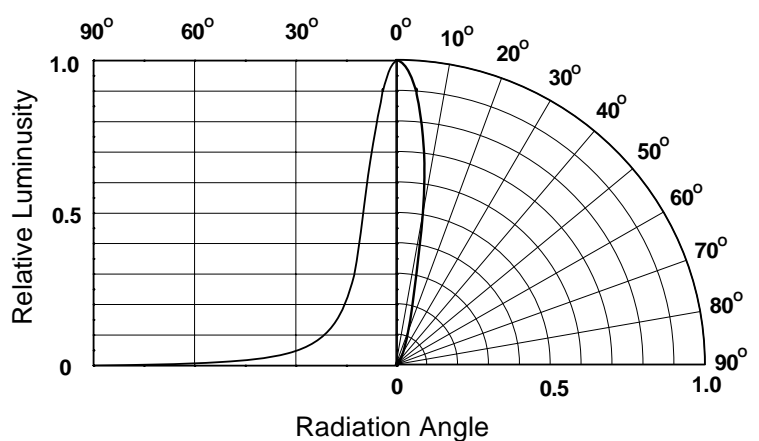





Technical Data Sheet

5 mm Round Warm White LED (T-13/4)

334-15/X2C1-1UWB

Label Form Specification

EVERLIGHT	
CPN:	
P/N:	
	RoHS
334-15/X2C1-1UWB	
QTY :	CAT:
	HUE:
LOT NO :	REF:
	
MADE IN TAIWAN	

CPN: Customer's Production Number

P/N : Production Number

QTY: Packing Quantity

CAT: Ranks

HUE: Space

REF: Reference

LOT No: Lot Number

MADE IN TAIWAN: Production Place



Technical Data Sheet

5 mm Round Warm White LED (T-13/4)

334-15/X2C1-1UWB

Notes

1. Above specification may be changed without notice. EVERLIGHT will reserve authority on material change for above specification.
2. When using this product, please observe the absolute maximum ratings and the instructions for using outlined in these specification sheets. EVERLIGHT assumes no responsibility for any damage resulting from use of the product which does not comply with the absolute maximum ratings and the instructions included in these specification sheets.
3. These specification sheets include materials protected under copyright of EVERLIGHT corporation. Please don't reproduce or cause anyone to reproduce them without EVERLIGHT's consent.
4. Below the zener reference voltage V_z , all the current flows through LED and as the voltage rises to V_z , the zener diode "breakdown." If the voltage tries to rise above V_z current flows through the zener branch to keep the voltage at exactly V_z .
5. When the LED is connected using serial circuit, if either piece of LED is no light up but current can't flow through causing others to light down. In new design, the LED is parallel with zener diode. if either piece of LED is no light up but current can flow through causing others to light up

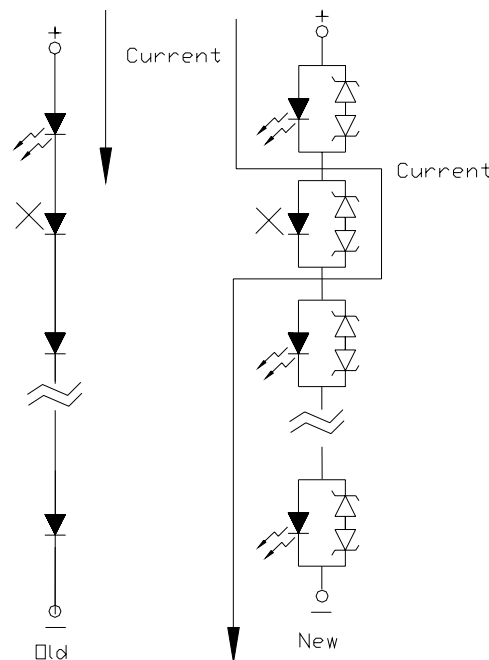

Technical Data Sheet

5 mm Round Warm White LED (T-13/4)

334-15/X2C1-1UWB

6. Soldering Condition

Careful attention should be paid during soldering. When soldering, leave more than 3mm from solder joint to case, and soldering beyond the base of the tie bar is recommended.

Avoiding applying any stress to the lead frame while the LEDs are at high temperature particularly when soldering.

Recommended soldering conditions:

Hand Soldering		DIP Soldering	
Temp. at tip of iron	400°C Max. (30W Max.)	Preheat temp.	100°C Max. (60 sec Max.)
Soldering time	3 sec Max.	Bath temp.	265 Max.
Distance	3mm Min.(From solder joint to case)	Bath time.	5 sec Max.
		Distance	3mm Min.

EVERLIGHT ELECTRONICS CO., LTD.
Office: No 25, Lane 76, Sec 3, Chung Yang Rd,
Tucheng, Taipei 236, Taiwan, R.O.C

Tel: 886-2-2267-2000, 2267-9936
Fax: 886-2267-6244, 2267-6189, 2267-6306
<http://www.everlight.com>