

SN54284, SN54285, SN74284, SN74285 4-BIT BY 4-BIT PARALLEL BINARY MULTIPLIERS

MAY 1972 — REVISED MARCH 1988

- Fast Multiplication of Two Binary Numbers
8-Bit Product in 40 ns Typical
- Expandable for N-Bit-by-n-Bit Applications:
16-Bit Product in 70 ns Typical
32-Bit Product in 103 ns Typical
- Fully Compatible with Most TTL Circuits
- Diode-Clamped Inputs Simplify System Design

SN54284 . . . J OR W PACKAGE
SN74284 . . . N PACKAGE
(TOP VIEW)

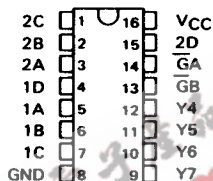

SN54285 . . . J OR W PACKAGE
SN74285 . . . N PACKAGE
(TOP VIEW)

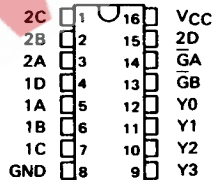

description

These high-speed TTL circuits are designed to be used in high-performance parallel multiplication applications. When connected as shown in Figure A, these circuits perform the positive-logic multiplication of two 4-bit binary words. The eight-bit binary product is generated with typically only 40 nanoseconds delay.

This basic four-by-four multiplier can be utilized as a fundamental building block for implementing larger multipliers. For example, the four-by-four building blocks can be connected as shown in Figure B to generate submultiple partial products. These results can then be summed in a Wallace tree, and, as illustrated, will produce a 16-bit product for the two eight-bit words typically in 70 nanoseconds. SN54H183/SN74H183 carry-save adders and SN54S181/SN74S181 arithmetic logic units with the SN54S182/SN74S182 look-ahead generator are used to achieve this high performance. The scheme is expandable for implementing $N \times M$ bit multipliers.

The SN54284 and SN54285 are characterized for operation over the full military temperature range of -55°C to 125°C ; the SN74284 and SN74285 are characterized for operation from 0°C to 70°C .

logic symbols†

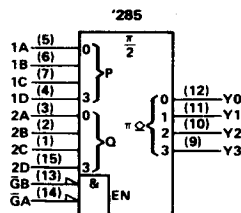
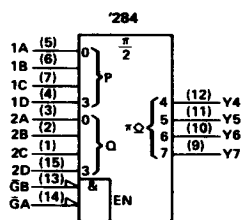

†These symbols are in accordance with ANSI/IEEE Std. 91-1984 and IEC Publication 617-12.

2

TTL Devices

PRODUCTION DATA documents contain information current as of publication date. Products conform to specifications per the terms of Texas Instruments standard warranty. Production processing does not necessarily include testing of all parameters.

**TEXAS
INSTRUMENTS**

POST OFFICE BOX 655012 • DALLAS, TEXAS 75285

2-787

SN54284, SN54285, SN74284, SN74285
4-BIT BY 4-BIT PARALLEL BINARY MULTIPLIERS

schematics

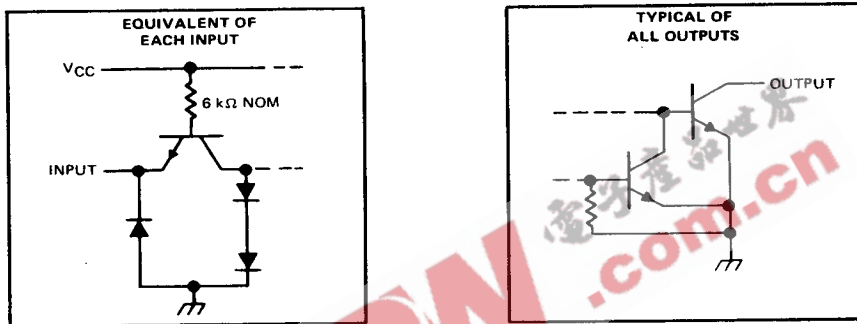

2

TTL Devices

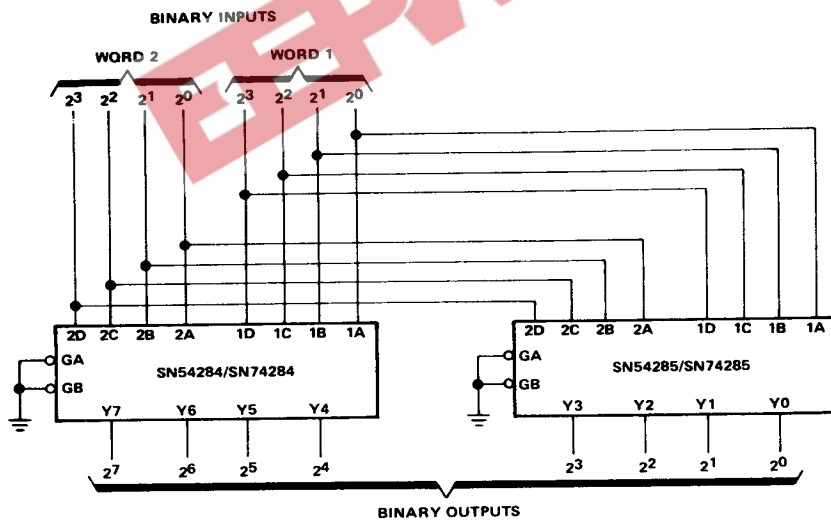

FIGURE A-4 X 4 MULTIPLIER

**SN54284, SN54285, SN74284, SN74285
4-BIT BY 4-BIT PARALLEL BINARY MULTIPLIERS**

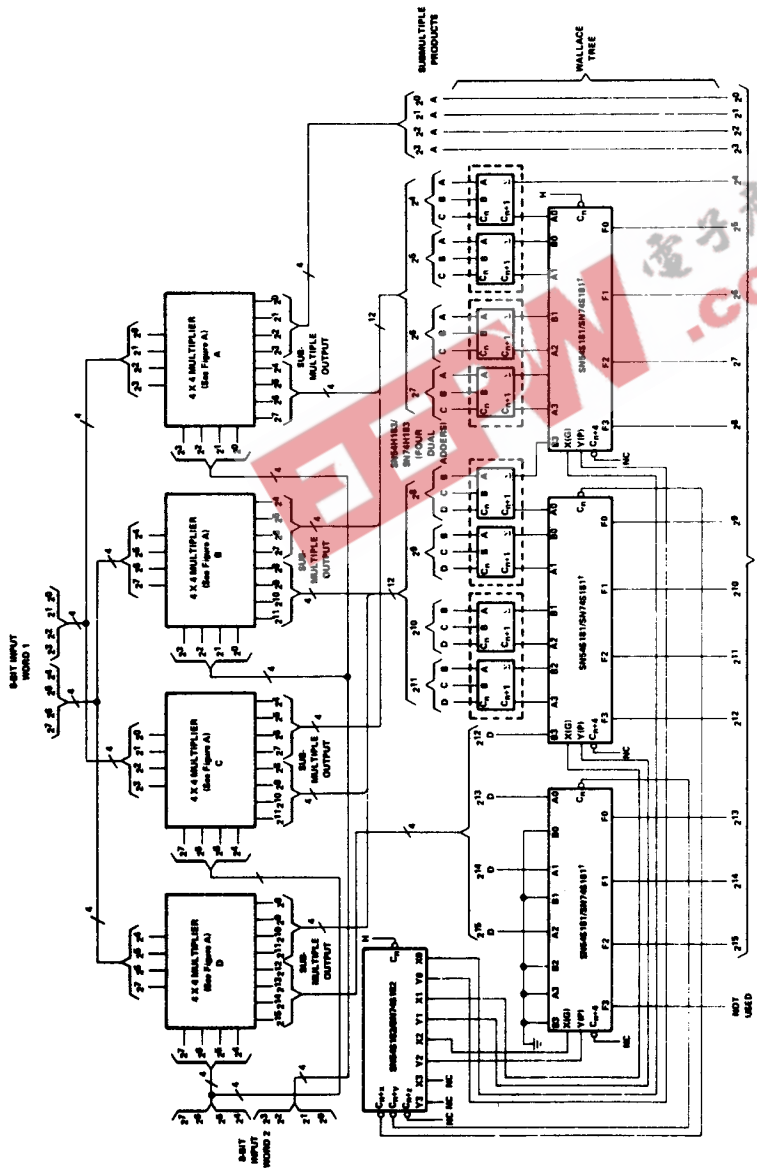

FIGURE 8-8 X 8 MULTIPLIER

¹ Other terminals of the three SN54S181/SN74S181 ALU's are connected as follows: S3 = H, S2 = L, S1 = L, S0 = H, M = L, OUTPUT A = 8 if not used for this application.

SN54284, SN54285, SN74284, SN74285
4-BIT BY 4-BIT PARALLEL BINARY MULTIPLIERS

absolute maximum ratings over operating free-air temperature range (unless otherwise noted)

| | |
|--|----------------|
| Supply voltage, V_{CC} (see Note 1) | 7 V |
| Input voltage | 5.5 V |
| Operating free-air temperature range: SN54 [†] Circuits | -55°C to 125°C |
| SN74 [†] Circuits | 0°C to 70°C |
| Storage temperature range | -65°C to 150°C |

NOTE 1: Voltage values are with respect to network ground terminal.

recommended operating conditions

| | SN54284 | | | SN74284 | | | UNIT |
|---------------------------------------|---------|-----|-----|---------|-----|------|----------|
| | MIN | NOM | MAX | MIN | NOM | MAX | |
| Supply voltage, V_{CC} | 4.5 | 5 | 5.5 | 4.75 | 5 | 5.25 | V |
| High-level output voltage, V_{OH} | 5.5 | | | 5.5 | | | V |
| Low-level output current, I_{OL} | 16 | | | 16 | | | mA |
| Operating free-air temperature, T_A | -55 | | | 0 | | | 70 °C |

electrical characteristics over recommended operating free-air temperature range (unless otherwise noted)

| PARAMETER | TEST CONDITIONS [†] | MIN | TYP [‡] | MAX | UNIT |
|--|---|--------------------------|------------------|-----|------|
| V_{IH} High-level input voltage | | 2 | | | V |
| V_{IL} Low-level input voltage | | 0.8 | | | V |
| V_I Input clamp voltage | $V_{CC} = \text{MIN}$, $I_I = -12 \text{ mA}$ | -1.5 | | | V |
| I_{OH} High-level output current | $V_{CC} = \text{MIN}$, $V_{IH} = 2 \text{ V}$, $V_{IL} = 0.8 \text{ V}$, $V_{OH} = 5.5 \text{ V}$ | 40 | | | μA |
| V_{OL} Low-level output voltage | $V_{CC} = \text{MIN}$, $V_{IH} = 2 \text{ V}$, $V_{IL} = 0.8 \text{ V}$ | $I_{OL} = 12 \text{ mA}$ | 0.4 | | V |
| | | $I_{OL} = 16 \text{ mA}$ | 0.45 | | |
| I_I Input current at maximum input voltage | $V_{CC} = \text{MAX}$, $V_I = 5.5 \text{ V}$ | 1 | | | mA |
| I_{IH} High-level input current | $V_{CC} = \text{MAX}$, $V_I = 2.4 \text{ V}$ | 40 | | | μA |
| I_{IL} Low-level input current | $V_{CC} = \text{MAX}$, $V_I = 0.4 \text{ V}$ | -1 | | | mA |
| I_{CC} Supply current | $V_{CC} = \text{MAX}$, $T_A = 125^\circ\text{C}$, See Note 2 | SN54284, SN54285 | 99 | | mA |
| | | N package only | | | |
| | $V_{CC} = \text{MAX}$, See Note 2 | SN54284, SN54285 | 92 | 110 | |
| | | SN74284, SN74285 | 92 | 130 | |

[†] For conditions shown as MIN or MAX, use the appropriate value specified under recommended operating conditions for the applicable device type.

[‡] All typical values are at $V_{CC} = 5 \text{ V}$, $T_A = 25^\circ\text{C}$.

NOTE 2: With outputs open and both enable inputs grounded, I_{CC} is measured first by selecting an output product which contains three or more high-level bits, then by selecting an output product which contains four low-level bits.

switching characteristics, $V_{CC} = 5 \text{ V}$, $T_A = 25^\circ\text{C}$

| PARAMETER | TEST CONDITIONS | MIN | TYP | MAX | UNIT |
|---|---|-----|-----|-----|------|
| t_{PLH} Propagation delay time, low-to-high-level output from enable | $C_L = 30 \text{ pF}$ to GND, $R_{L1} = 300 \Omega$ to V_{CC} , $R_{L2} = 600 \Omega$ to GND, See Note 3 | 20 | | 30 | ns |
| t_{PHL} Propagation delay time, high-to-low-level output from enable | | 20 | | 30 | |
| t_{PLH} Propagation delay time, low-to-high-level output from word inputs | | 40 | | 60 | ns |
| t_{PHL} Propagation delay time, high-to-low-level output from word inputs | | 40 | | 60 | |

NOTE 3: Load circuits and voltage waveforms are shown in Section 1.