



STFV4N150 - STFW4N150 STP4N150 - STW4N150

N-channel 1500 V - 5 Ω - 4 A - PowerMESH™ Power MOSFET
TO-220 - TO-220FH - TO-247 - TO-3PF

Features

Type	V _{DSS}	R _{DS(on)} max	I _D
STFV4N150	1500 V	< 7 Ω	4 A
STFW4N150 ⁽¹⁾	1500 V	< 7 Ω	4 A
STP4N150	1500 V	< 7 Ω	4 A
STW4N150	1500 V	< 7 Ω	4 A

1. All data which refers solely to the TO-3PF package is preliminary

- 100% avalanche tested
- Intrinsic capacitances and Q_g minimized
- High speed switching
- Fully isolated TO-3PF and TO-220FH plastic packages
- Creepage distance path is 5.4 mm (typ.) for TO-3PF
- Creepage distance path is > 4 mm for TO-220FH

Application

- Switching applications

Description

Using the well consolidated high voltage MESH OVERLAY™ process, STMicroelectronics has designed an advanced family of very high voltage Power MOSFETs with outstanding performances. The strengthened layout coupled with the company's proprietary edge termination structure, gives the lowest R_{DS(on)} per area, unrivalled gate charge and switching characteristics.

Table 1. Device summary

Order codes	Marking	Package	Packaging
STFV4N150	4N150	TO-220FH	Tube
STFW4N150	4N150	TO-3PF	Tube
STP4N150	P4N150	TO-220	Tube
STW4N150	W4N150	TO-247	Tube

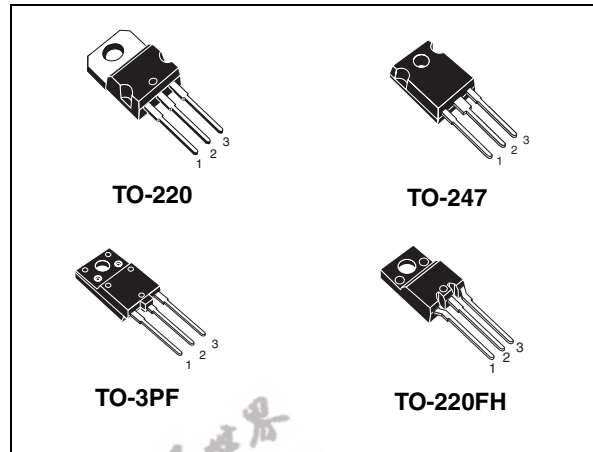
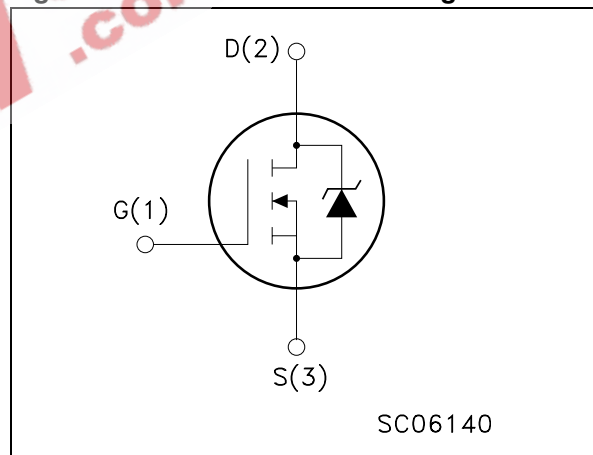

Figure 1. Internal schematic diagram.



Contents

1	Electrical ratings	3
2	Electrical characteristics	4
2.1	Electrical characteristics (curves)	6
3	Test circuits	9
4	Package mechanical data	10
5	Revision history	15



1 Electrical ratings

Table 2. Absolute maximum ratings

Symbol	Parameter	Value				Unit
		TO-220	TO-247	TO-220FH	TO-3PF	
V_{DS}	Drain-source voltage ($V_{GS} = 0$)	1500				V
V_{GS}	Gate- source voltage	± 30				V
I_D	Drain current (continuous) at $T_C = 25\text{ }^\circ\text{C}$	4	4	4 ⁽¹⁾	4 ⁽¹⁾	A
I_D	Drain current (continuous) at $T_C = 100\text{ }^\circ\text{C}$	2.5	2.5	2.5 ⁽¹⁾	2.5 ⁽¹⁾	A
$I_{DM}^{(1)}$	Drain current (pulsed)	12	12	12 ⁽¹⁾	12 ⁽¹⁾	A
P_{TOT}	Total dissipation at $T_C = 25\text{ }^\circ\text{C}$	160		40	Tbd	W
T_{stg}	Storage temperature	-55 to 150				$^\circ\text{C}$
T_j	Max. operating junction temperature	150				$^\circ\text{C}$

1. Pulse width limited by safe operating area

Table 3. Thermal data

Symbol	Parameter	Value				Unit
		TO-220	TO-247	TO-220FH	TO-3PF	
$R_{thj-case}$	Thermal resistance junction-case max	0.78		3.12	Tbd	$^\circ\text{C}/\text{W}$
$R_{thj-amb}$	Thermal resistance junction-ambient max	62.5	50	62.5		$^\circ\text{C}/\text{W}$

Table 4. Avalanche characteristics

Symbol	Parameter	Value	Unit
I_{AR}	Avalanche current, repetitive or not-repetitive (pulse width limited by T_j max)	4	A
E_{AS}	Single pulse avalanche energy (starting $T_j = 25\text{ }^\circ\text{C}$, $I_D = I_{AR}$, $V_{DD} = 50\text{ V}$)	350	mJ

2 Electrical characteristics

($T_{CASE}=25^{\circ}C$ unless otherwise specified)

Table 5. On/off states

Symbol	Parameter	Test conditions	Min.	Typ.	Max.	Unit
$V_{(BR)DSS}$	Drain-source Breakdown voltage	$I_D = 1 \text{ mA}, V_{GS} = 0$	1500			V
I_{DSS}	Zero gate voltage Drain current ($V_{GS} = 0$)	$V_{DS} = \text{Max rating}$ $V_{DS} = \text{Max rating}, T_C = 125^{\circ}C$			10 500	μA μA
I_{GSS}	Gate-body leakage current ($V_{DS} = 0$)	$V_{GS} = \pm 30 \text{ V}$			± 100	nA
$V_{GS(th)}$	Gate threshold voltage	$V_{DS} = V_{GS}, I_D = 250 \mu\text{A}$	3	4	5	V
$R_{DS(on)}$	Static drain-source on resistance	$V_{GS} = 10 \text{ V}, I_D = 2 \text{ A}$		5	7	Ω

Table 6. Dynamic

Symbol	Parameter	Test conditions	Min.	Typ.	Max.	Unit
$g_{fs}^{(1)}$	Forward transconductance	$V_{DS} = 30 \text{ V}, I_D = 2 \text{ A}$		3.5		S
C_{iss}	Input capacitance	$V_{DS} = 25 \text{ V}, f = 1 \text{ MHz},$ $V_{GS} = 0$		1300		pF
C_{oss}	Output capacitance			120		pF
C_{rss}	Reverse transfer capacitance			12		pF
$t_{d(on)}$	Turn-on delay time	$V_{DD} = 750 \text{ V}, I_D = 2 \text{ A},$ $R_G = 4.7 \Omega, V_{GS} = 10 \text{ V}$ <i>(see Figure 21)</i>		35		ns
T_r	Rise time			30		ns
$t_{d(off)}$	Turn-off delay time			45		ns
t_f	Fall time			45		ns
Q_g	Total gate charge	$V_{DD} = 600 \text{ V}, I_D = 4 \text{ A},$ $V_{GS} = 10 \text{ V}$ <i>(see Figure 22)</i>		30	50	nC
Q_{gs}	Gate-source charge			10		nC
Q_{gd}	Gate-drain charge			9		nC

1. Pulsed: pulse duration=300 μs , duty cycle 1.5%

Table 7. Source drain diode

Symbol	Parameter	Test conditions	Min.	Typ.	Max.	Unit
I_{SD}	Source-drain current				4	A
$I_{SDM}^{(1)}$	Source-drain current (pulsed)				12	A
$V_{SD}^{(2)}$	Forward on voltage	$I_{SD} = 4 \text{ A}, V_{GS} = 0$			2	V
t_{rr}	Reverse recovery time	$I_{SD} = 4 \text{ A},$ $di/dt = 100 \text{ A}/\mu\text{s}$ $V_{DD} = 45 \text{ V}$ <i>(see Figure 21)</i>		510		ns
Q_{rr}	Reverse recovery charge			3		μC
I_{RRM}	Reverse recovery current			12		A
t_{rr}	Reverse recovery time	$I_{SD} = 4 \text{ A},$ $di/dt = 100 \text{ A}/\mu\text{s}$ $V_{DD} = 45 \text{ V}, T_j = 150^\circ\text{C}$ <i>(see Figure 21)</i>		615		ns
Q_{rr}	Reverse recovery charge			4		μC
I_{RRM}	Reverse recovery current			12.6		A

1. Pulse width limited by safe operating area
2. Pulsed: pulse duration=300 μs , duty cycle 1.5%

EEPW 电子产品世界
www.eepw.com.cn

2.1 Electrical characteristics (curves)

Figure 2. Safe operating area for TO-220

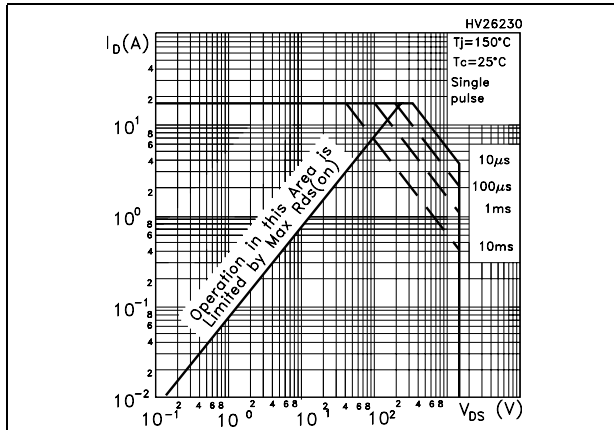

Figure 3. Thermal impedance for TO-220

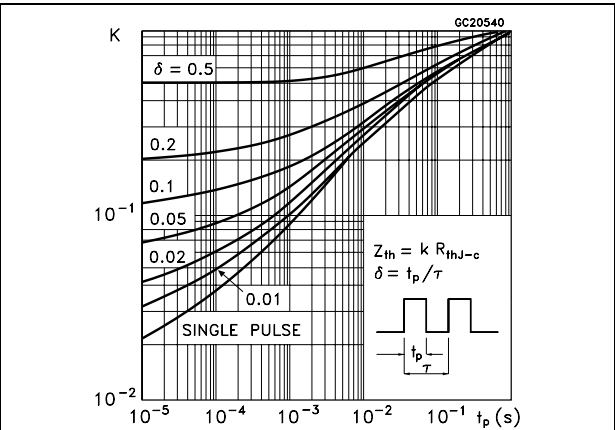

Figure 4. Safe operating area for TO-220FH

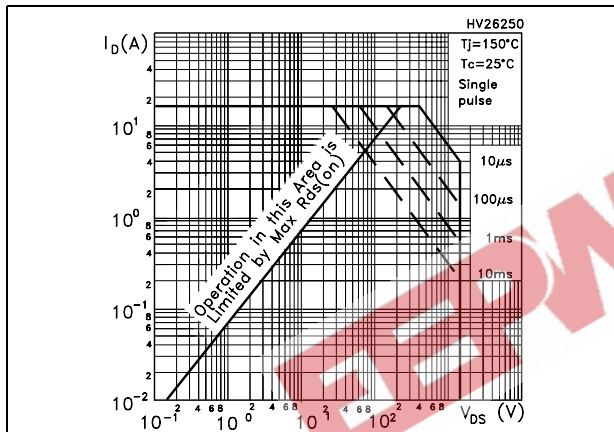

Figure 5. Thermal impedance for TO-220FH

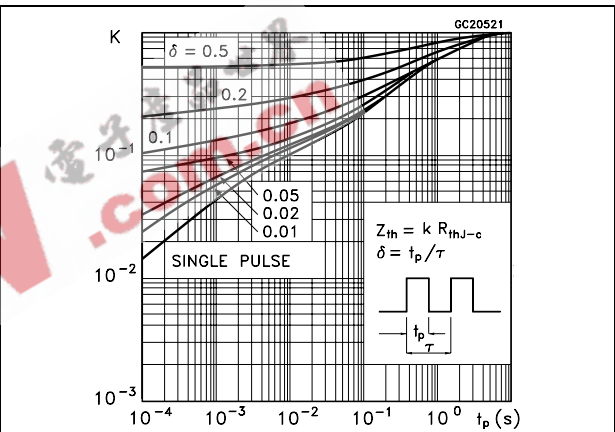

Figure 6. Safe operating area for TO-247

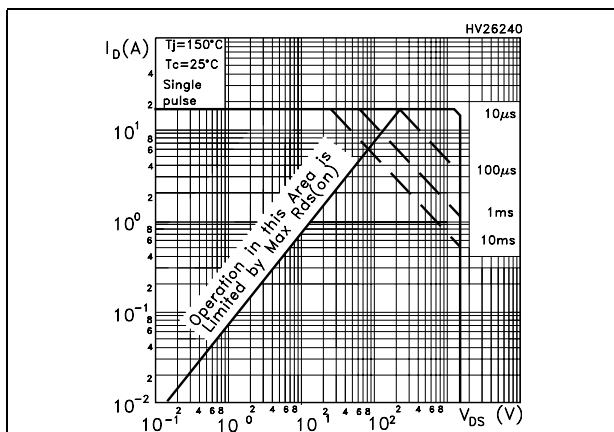

Figure 7. Thermal impedance for TO-247

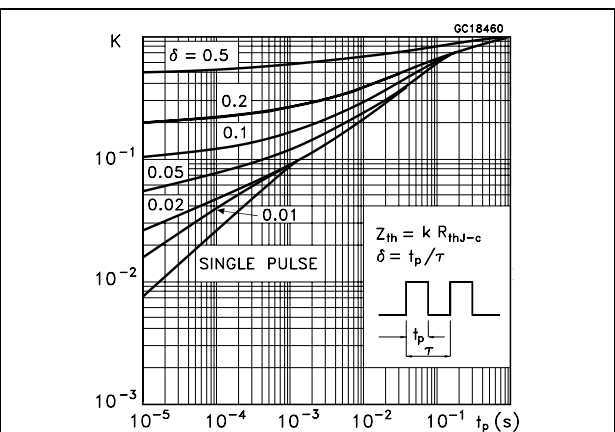

Figure 8. Output characteristics

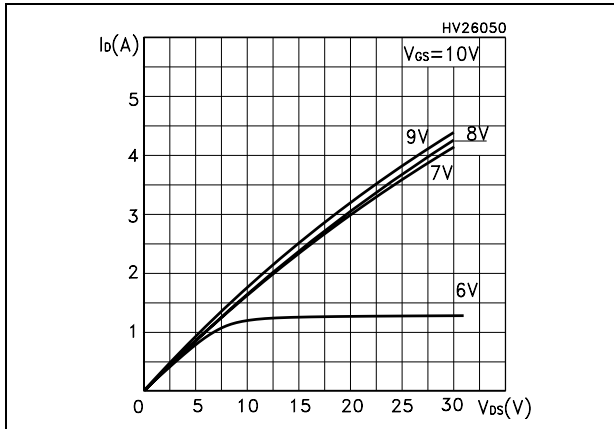

Figure 9. Transfer characteristics

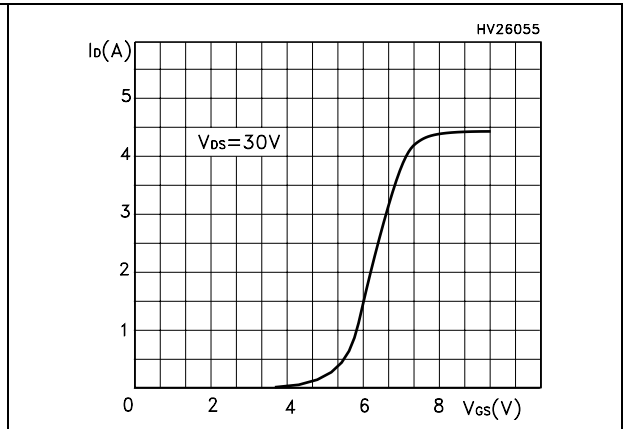

Figure 10. Transconductance

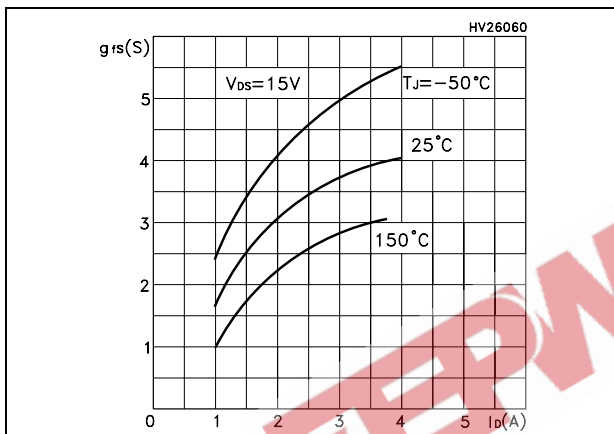

Figure 11. Static drain-source on resistance

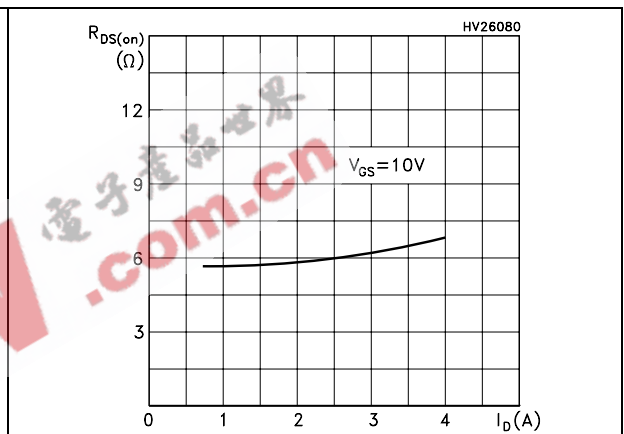

Figure 12. Gate charge vs gate-source voltage Figure 13. Capacitance variations

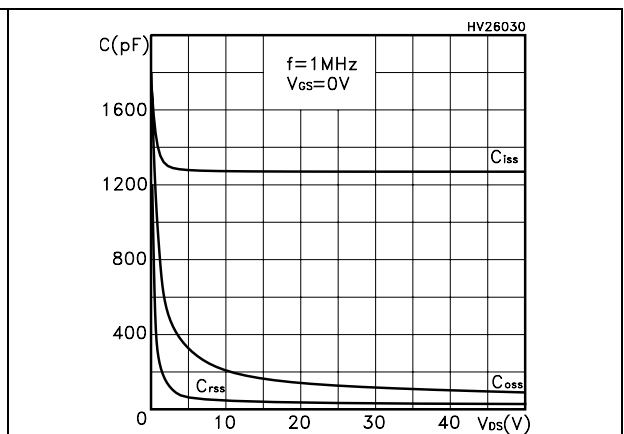
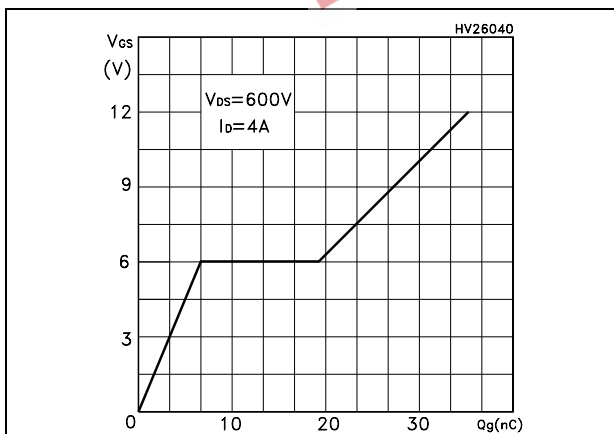

Figure 14. Normalized gate threshold voltage vs temperature

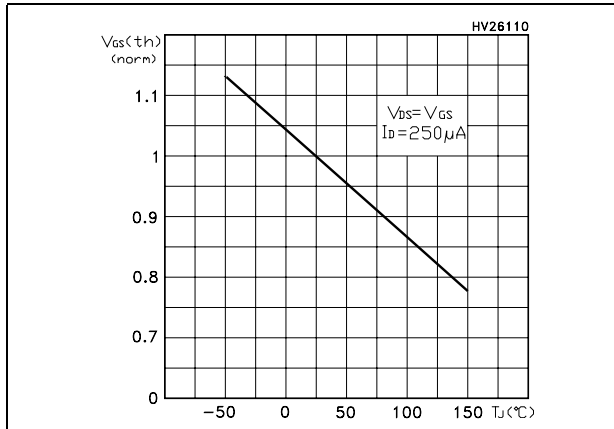

Figure 15. Normalized on resistance vs temperature

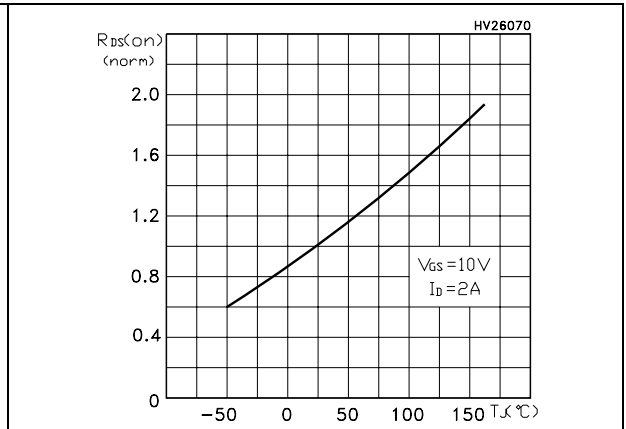

Figure 16. Source-drain diode forward characteristics

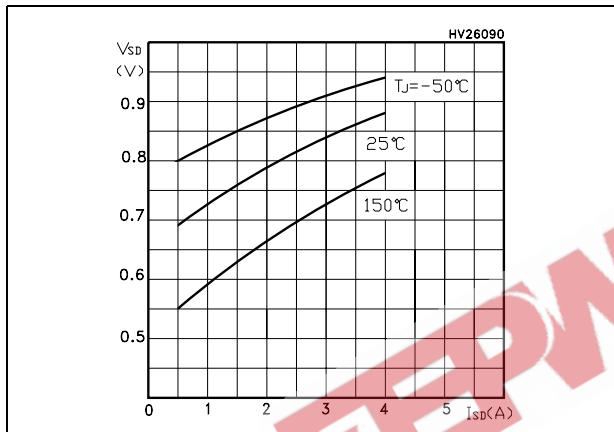

Figure 17. Normalized $B_{V_{DSS}}$ vs temperature

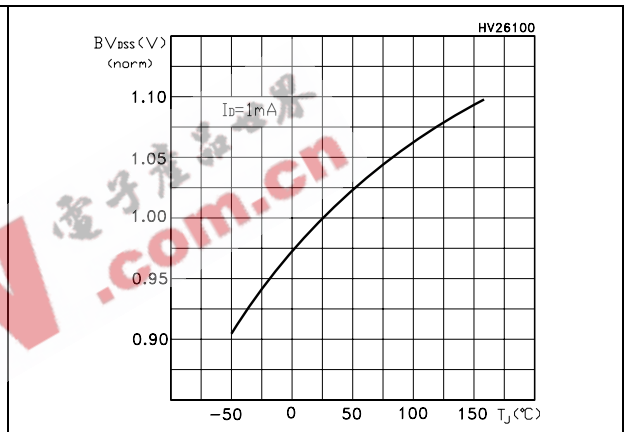
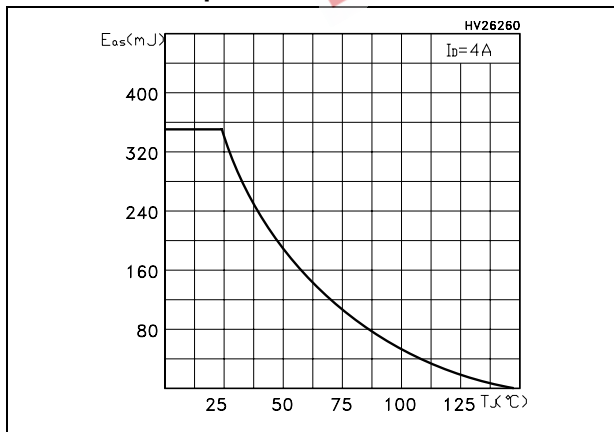

Figure 18. Maximum avalanche energy vs temperature



3 Test circuits

Figure 19. Unclamped inductive load test circuit

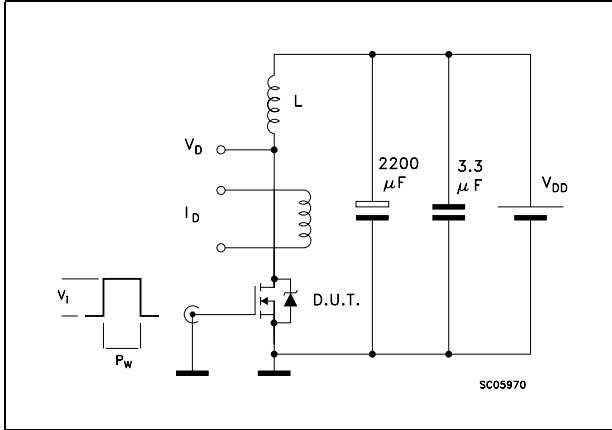

Figure 20. Unclamped inductive waveform

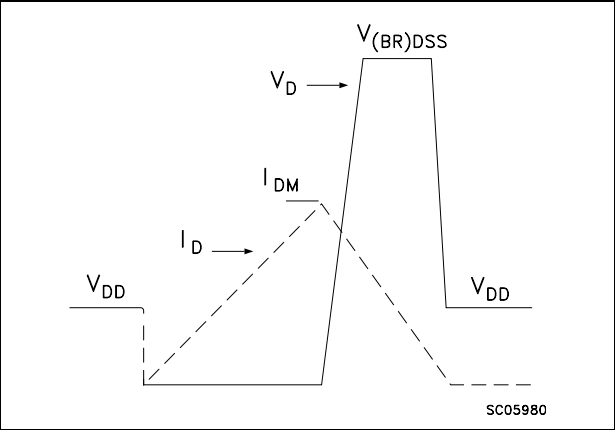

Figure 21. Switching times test circuit for resistive load

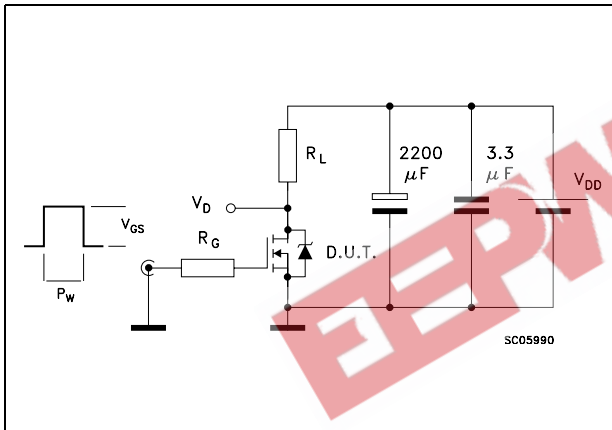

Figure 22. Gate charge test circuit

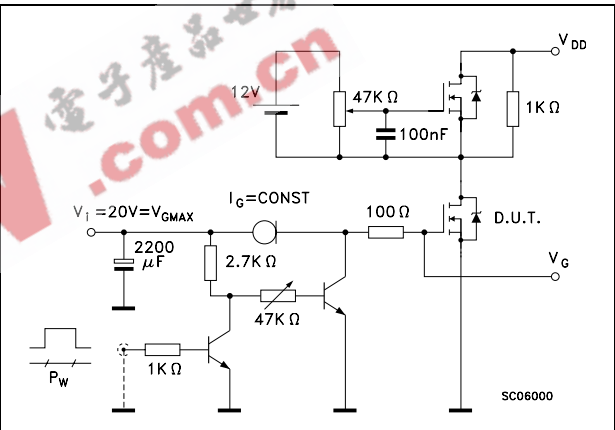

Figure 23. Test circuit for inductive load switching and diode recovery times

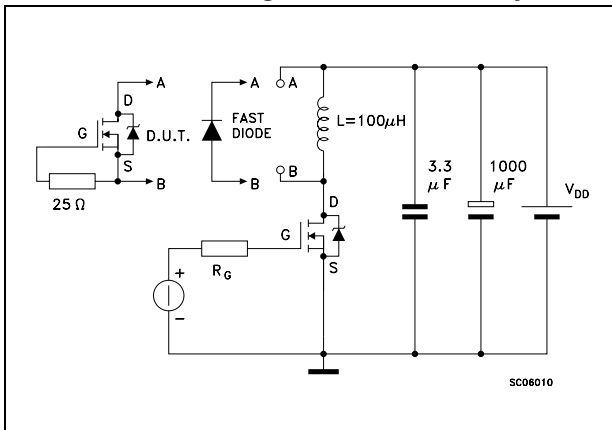
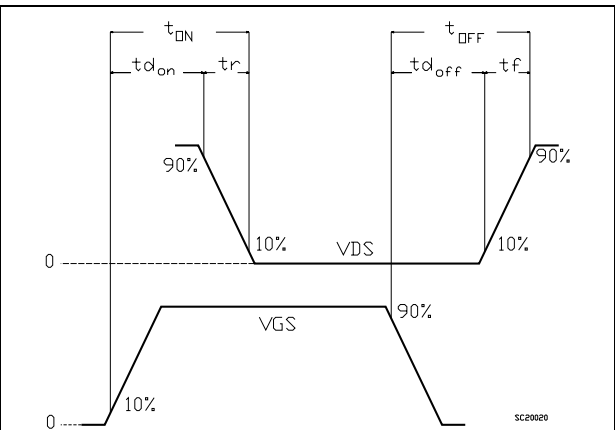

Figure 24. Switching time waveform



4 Package mechanical data

In order to meet environmental requirements, ST offers these devices in ECOPACK® packages. These packages have a lead-free second level interconnect. The category of second level interconnect is marked on the package and on the inner box label, in compliance with JEDEC Standard JESD97. The maximum ratings related to soldering conditions are also marked on the inner box label. ECOPACK is an ST trademark. ECOPACK specifications are available at: www.st.com

EEPW 电子產品世界
.com.cn

TO-220 mechanical data

Dim	mm			inch		
	Min	Typ	Max	Min	Typ	Max
A	4.40		4.60	0.173		0.181
b	0.61		0.88	0.024		0.034
b1	1.14		1.70	0.044		0.066
c	0.48		0.70	0.019		0.027
D	15.25		15.75	0.6		0.62
D1		1.27			0.050	
E	10		10.40	0.393		0.409
e	2.40		2.70	0.094		0.106
e1	4.95		5.15	0.194		0.202
F	1.23		1.32	0.048		0.051
H1	6.20		6.60	0.244		0.256
J1	2.40		2.72	0.094		0.107
L	13		14	0.511		0.551
L1	3.50		3.93	0.137		0.154
L20		16.40			0.645	
L30		28.90			1.137	
∅P	3.75		3.85	0.147		0.151
Q	2.65		2.95	0.104		0.116

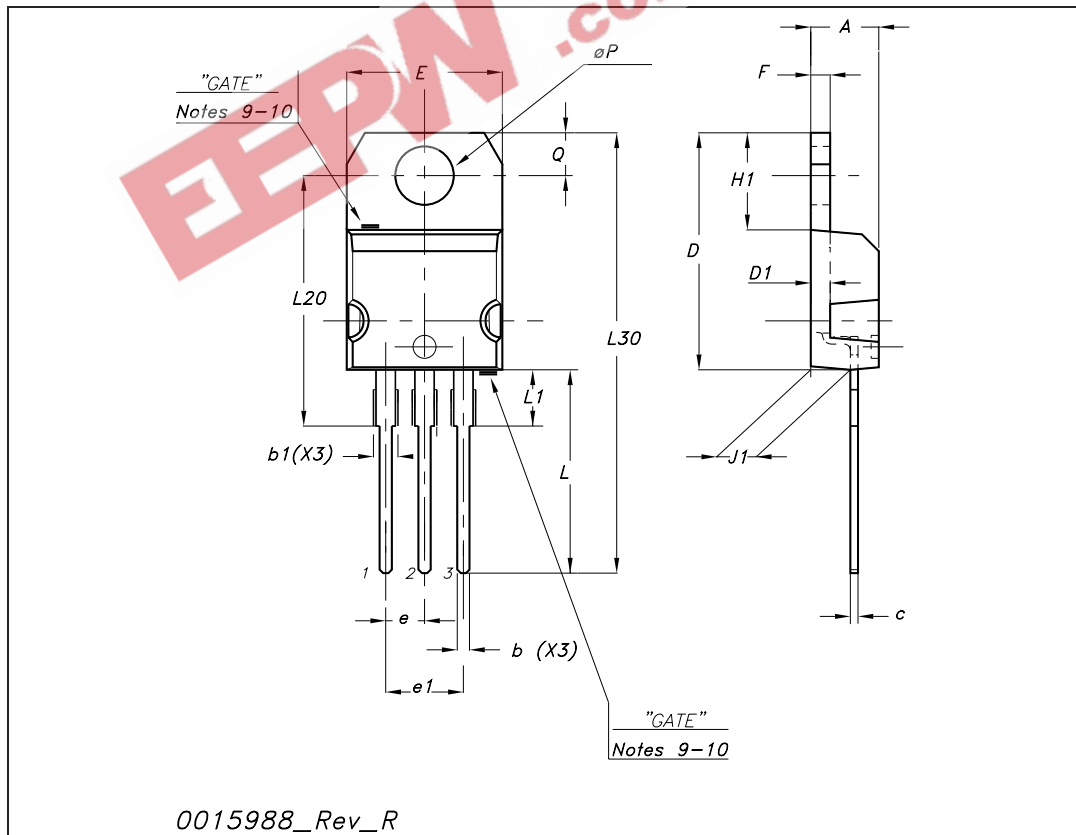

TO-247 Mechanical data

Dim.	mm.		
	Min.	Typ	Max.
A	4.85		5.15
A1	2.20		2.60
b	1.0		1.40
b1	2.0		2.40
b2	3.0		3.40
c	0.40		0.80
D	19.85		20.15
E	15.45		15.75
e		5.45	
L	14.20		14.80
L1	3.70		4.30
L2		18.50	
øP	3.55		3.65
øR	4.50		5.50
S		5.50	

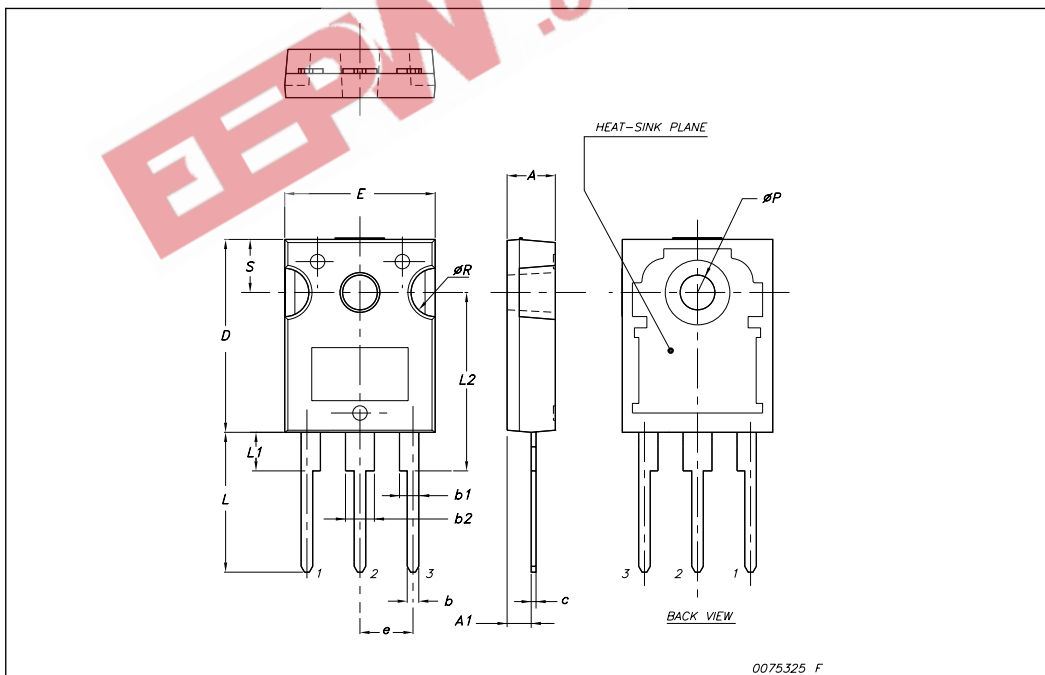

TO-220FH (Fully plastic High voltage) MECHANICAL DATA

DIM.	mm			inch		
	MIN.	TYP.	MAX.	MIN.	TYP.	MAX.
A	4.4		4.6	0.173		0.181
B	2.5		2.7	0.098		0.106
D	2.5		2.75	0.098		0.108
E	0.45		0.7	0.017		0.027
F	0.75		1	0.030		0.039
F1	1.3		1.8	0.051		0.070
F2	1.3		1.8	0.051		0.070
G	4.95		5.2	0.195		0.204
G1	2.4		2.7	0.094		0.106
H	10		10.4	0.393		0.409
L2		16			0.630	
L3	28.6		30.6	1.126		1.204
L4	9.8		10.6	0.385		0.417
L5		3.4			0.134	
L6	15.9		16.4	0.626		0.645
L7	9		9.3	0.354		0.366
L8	14.5		15	0.570		0.590
L9		2.4			0.094	

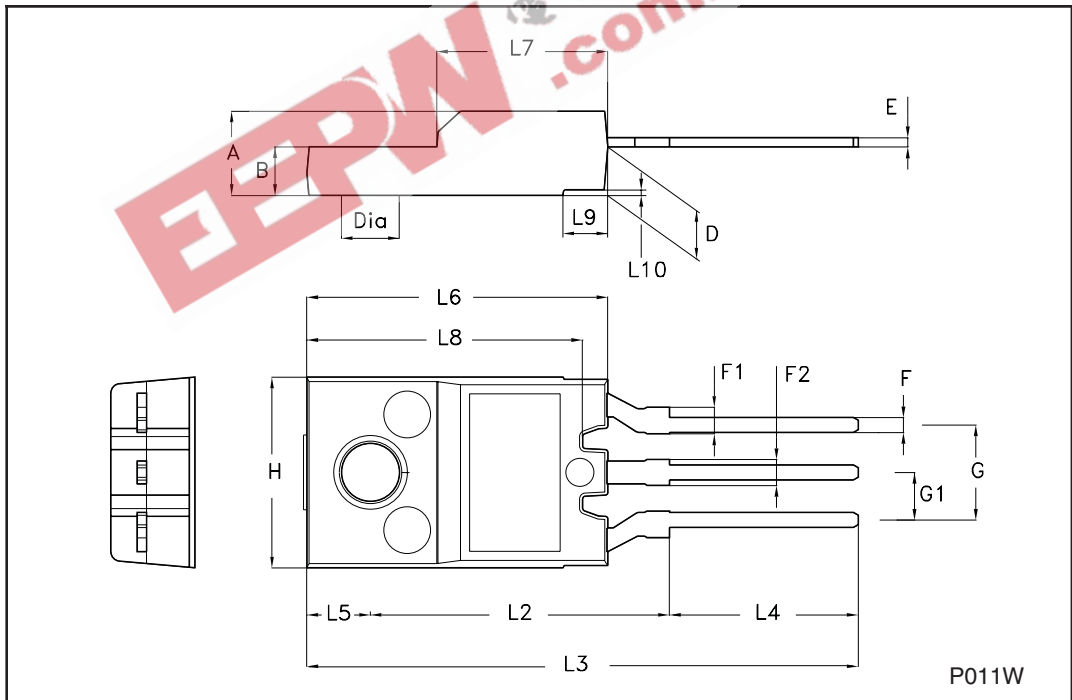

TO-3PF mechanical data

DIM.	mm.		
	min.	typ	max.
A	5.30		5.70
C	2.80		3.20
D	3.10		3.50
D1	1.80		2.20
E	0.80		1.10
F	0.65		0.95
F2	1.80		2.20
G	10.30		11.50
G1		5.45	
H	15.30		15.70
L	9.80	10	10.20
L2	22.80		23.20
L3	26.30		26.70
L4	43.20		44.40
L5	4.30		4.70
L6	24.30		24.70
L7	14.60		15
N	1.80		2.20
R	3.80		4.20
Dia	3.40		3.80

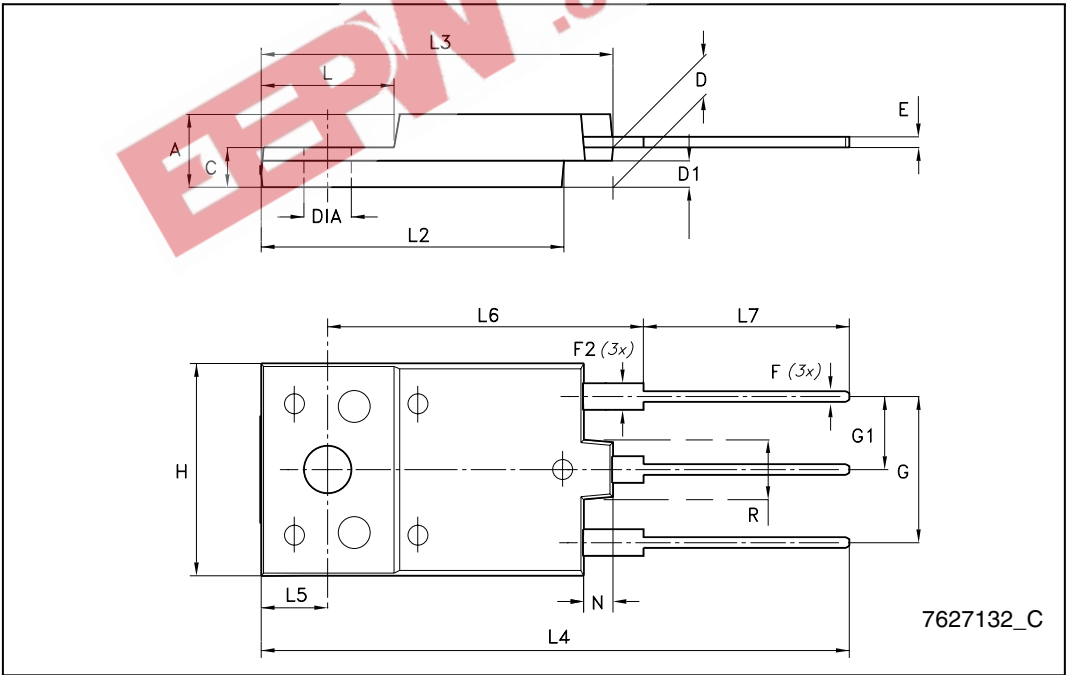

7627132_C

5 Revision history

Table 8. Document revision history

Date	Revision	Changes
29-Mar-2005	1	Initial release
07-Jul-2005	2	Removed TO-220FP
07-Oct-2005	3	Document status promoted from preliminary data to datasheet
10-Aug-2006	4	Document reformatted, no content change
06-Nov-2007	5	Updated unit on Table 5: On/off states
09-Apr-2008	6	Added new packages: TO-220FH, TO-3PF

EEPW 电子产品世界
.com.cn

Please Read Carefully:

Information in this document is provided solely in connection with ST products. STMicroelectronics NV and its subsidiaries ("ST") reserve the right to make changes, corrections, modifications or improvements, to this document, and the products and services described herein at any time, without notice.

All ST products are sold pursuant to ST's terms and conditions of sale.

Purchasers are solely responsible for the choice, selection and use of the ST products and services described herein, and ST assumes no liability whatsoever relating to the choice, selection or use of the ST products and services described herein.

No license, express or implied, by estoppel or otherwise, to any intellectual property rights is granted under this document. If any part of this document refers to any third party products or services it shall not be deemed a license grant by ST for the use of such third party products or services, or any intellectual property contained therein or considered as a warranty covering the use in any manner whatsoever of such third party products or services or any intellectual property contained therein.

UNLESS OTHERWISE SET FORTH IN ST'S TERMS AND CONDITIONS OF SALE ST DISCLAIMS ANY EXPRESS OR IMPLIED WARRANTY WITH RESPECT TO THE USE AND/OR SALE OF ST PRODUCTS INCLUDING WITHOUT LIMITATION IMPLIED WARRANTIES OF MERCHANTABILITY, FITNESS FOR A PARTICULAR PURPOSE (AND THEIR EQUIVALENTS UNDER THE LAWS OF ANY JURISDICTION), OR INFRINGEMENT OF ANY PATENT, COPYRIGHT OR OTHER INTELLECTUAL PROPERTY RIGHT.

UNLESS EXPRESSLY APPROVED IN WRITING BY AN AUTHORIZED ST REPRESENTATIVE, ST PRODUCTS ARE NOT RECOMMENDED, AUTHORIZED OR WARRANTED FOR USE IN MILITARY, AIR CRAFT, SPACE, LIFE SAVING, OR LIFE SUSTAINING APPLICATIONS, NOR IN PRODUCTS OR SYSTEMS WHERE FAILURE OR MALFUNCTION MAY RESULT IN PERSONAL INJURY, DEATH, OR SEVERE PROPERTY OR ENVIRONMENTAL DAMAGE. ST PRODUCTS WHICH ARE NOT SPECIFIED AS "AUTOMOTIVE GRADE" MAY ONLY BE USED IN AUTOMOTIVE APPLICATIONS AT USER'S OWN RISK.

Resale of ST products with provisions different from the statements and/or technical features set forth in this document shall immediately void any warranty granted by ST for the ST product or service described herein and shall not create or extend in any manner whatsoever, any liability of ST.

ST and the ST logo are trademarks or registered trademarks of ST in various countries.

Information in this document supersedes and replaces all information previously supplied.

The ST logo is a registered trademark of STMicroelectronics. All other names are the property of their respective owners.

© 2008 STMicroelectronics - All rights reserved

STMicroelectronics group of companies

Australia - Belgium - Brazil - Canada - China - Czech Republic - Finland - France - Germany - Hong Kong - India - Israel - Italy - Japan - Malaysia - Malta - Morocco - Singapore - Spain - Sweden - Switzerland - United Kingdom - United States of America

www.st.com