

C&K Y Series 4, 5 & 6 Tumbler Switchlocks

Features/Benefits

- **Anti-static switch—exceeds 20 KV DC static resistance**
- **Momentary models available**
- **Wire leads and harnesses available**

Typical Applications

- **Point-of-sale terminals**
- **Cash registers**
- **Computers**



Patent No. 4,639,562



Specifications

CONTACT RATING: Q contact material: 4 AMPS @ 125 V AC or 28 V DC; 2 AMPS @ 250 V AC (UL/CSA). See page M-9 for additional ratings.

ELECTRICAL LIFE: 10,000 make-and-break cycles at full load.

CONTACT RESISTANCE: Below 10 m Ω typ. initial @ 2-4 V DC, 100 mA, for both silver and gold plated contacts.

INSULATION RESISTANCE: 10⁹ Ω min.

DIELECTRIC STRENGTH: 1,000 Vrms min. @ sea level.

INDEXING: 45° or 90°, 2-4 positions (4&5 tumbler switchlocks). 45°, 3 positions; or 90°, 2 positions (6 tumbler tubular switchlocks).

Other functions available, consult Customer Service Center.

STATIC RESISTANCE: Anti-static models exceed 20 KV DC static resistance @ sea level, lock body to terminals.

MOUNTING TORQUE: 10 in./lbs.; 14 in./lbs max.

Materials

LOCK: Zinc alloy with stainless steel facing, std. (4 & 5 tumbler lock and 6 tumbler tubular lock).

KEYS: Two nickel plated brass keys, with code number, std. (4 and 5 tumbler lock). Two die cast chrome plated zinc alloy keys, std. (6 tumbler lock).

SWITCH HOUSING: Glass filled polyester (UL 94V-0).

CONTACTS AND TERMINALS: Q contact material: Copper, silver plated. See page M-9 for additional contact materials.

MOUNTING NUT: Zinc alloy.

MOUNTING CLIP: Steel, zinc plated.

DRESS NUT: Brass, nickel plated.

TERMINAL SEAL: Epoxy.

NOTE: Any models supplied with Q, B or G contact material are RoHS compliant. For the latest information regarding RoHS compliance, please go to: www.ittcannon.com/rohs.

NOTE: Specifications and materials listed above are for switchlocks with standard options. For information on specific and custom switchlocks, consult Customer Service Center.

Build-A-Switch

To order, simply select desired option from each category and place in the appropriate box. Available options are shown and described on pages M-4 through M-10. For additional options not shown in catalog, consult Customer Service Center.

Switch and Lock Function

- Y10013** SP, 45°, keypull pos. 1
- Y1011U** SP, 90°, keypull pos. 1 & 2
- Y1001U** SP, 40°, keypull pos. 1 & 3
- Y2001U** DP, 40°, keypull pos. 1 & 3
- Y10082** SP, 40°, keypull pos. 1
- Y20082** DP, 40°, keypull pos. 1
- Y100AA** SP, 40°, keypull pos. 1, 2 & 3
- Y200AA** DP, 40°, keypull pos. 1, 2 & 3
- Y100AB** SP, 40°, keypull pos. 1, 2, 3 & 4
- Y200AB** DP, 40°, keypull pos. 1, 2, 3 & 4
- Y10113** SP, 90°, keypull pos. 1
- Y20113** DP, 90°, keypull pos. 1
- Y1011C** SP, 90°, keypull pos.2
- Y2011C** DP, 90°, keypull pos. 2
- Y2011U** DP, 90°, keypull pos. 1 & 2
- Y14173** SP, 90°, keypull pos. 1
- Y1417U** SP, 90°, keypull pos. 1,2 & 3
- Y10812** SP, 40°, mom., keypull pos. 1
- Y20812** DP, 45°, mom., keypull pos. 1
- Y19073** SP w/common, 90°, keypull pos. 1
- Y1907U** SP w/common, 90°, keypull pos. 1, 2 & 3
- Y1900S** SP w/common, 90°, keypull pos. 1, 2, 3 & 4

Keying

- 2** Two nickel plated brass keys (4 & 5 tumbler) or two die cast zinc alloy keys with chrome plating (6 tumbler)
- 6** Two nickel plated brass keys with code on lock face

Lock Type

- A** 4 Tumbler lock (YX08 models)
- C** 4 Tumbler lock with detent
- V** 6 Tumbler tubular lock
- B** 5 Tumbler lock
- R** 4 Tumbler lock with detent and anti-Static switch
- W** 6 Tumbler tubular lock with anti-Static switch

Lock Finish

- 2** Stainless steel facing
- 8** Gloss black facing
- F** Polished nickel facing

Terminations

- 03** Solder lug with hole
- 01** Solder lug with notch
- 02** PC Thru-hole
- 07** Solder lug with hole (Y190XX models only)
- WC** Wire lead

Mounting/Lock Style

- N** With nut
- D** With clip
- L** With removable dress nut and latch pawl
- R** With removable dress nut

Contact Material

- Q** Silver
- B** Gold
- G** Gold over silver

Seal

- NONE** No seal
- E** Epoxy seal



Dimensions are shown: Inch (mm)
Specifications and dimensions subject to change

C&K Y Series 4, 5 & 6 Tumbler Switchlocks

SWITCH AND LOCK FUNCTION



SINGLE & DOUBLE POLE SWITCHES									
NO. TUMBLERS	NO. POLES	MODEL NO.	CONNECTED TERMINALS				KEY PULL POSITIONS	LOCK CONFIGURATION	INDEXING
			POS. 1	POS. 2	POS. 3	POS. 4			
4, 5 & 6	SP	Y10013	8-1	1-2	2-3		Position 1		45°
4, 5 & 6	SP DP	Y1001U Y2001U	8-1 8-1, 4-5	1-2 1-2, 5-6	2-3 2-3, 6-7		Positions 1 & 3		
4 & 5	SP DP	Y10082 Y20082	8-1 8-1, 4-5	1-2 1-2, 5-6	7-8 7-8, 3-4		Position 1		
4	SP DP	Y100AA Y200AA	8-1 8-1, 4-5	1-2 1-2, 5-6	7-8 7-8, 3-4		Positions 1, 2 & 3		
4	SP DP	Y100AB Y200AB	8-1 8-1, 4-5	1-2 1-2, 5-6	2-3 2-3, 6-7	3-4 3-4, 7-8	Positions 1, 2, 3 & 4		
4, 5 & 6	SP DP	Y10113 Y20113	8-1 8-1, 4-5	1-3 1-3, 5-7			Position 1		90°
4 & 5	SP DP	Y1011C Y2011C	8-1 8-1, 4-5	1-3 1-3, 5-7			Position 2		
4, 5 & 6	SP DP	Y1011U Y2011U	8-1 8-1, 4-5	1-3 1-3, 5-7			Positions 1 & 2		
4	SP	Y14173	7-1	1-3	6-7		Position 1		
4	SP	Y1417U	7-1	1-3	6-7		Positions 1, 2 & 3		
SINGLE & DOUBLE POLE MOMENTARY SWITCHES									
NO. TUMBLERS	NO. POLES	MODEL NO.	CONNECTED TERMINALS				KEY PULL POSITIONS	LOCK CONFIGURATION	INDEXING
			POS. 1	POS. 2	POS. 3	POS. 4			
4	SP DP	Y10812 Y20812	8-1 8-1, 4-5	1-2 1-2, 5-6			Position 1		45° Mom.



Switchlock

LEGEND

- ▲ = Momentary Positions (45°)
- = Detent Positions (45° or 90°)
- ⊙ = Key pull possible in these positions.
- ⊙ = Stop Positions



TERMINAL NUMBERS



Terminal numbers molded on bottom of housing.

All models with all options when ordered with 'G' or 'Q' contact material.



Dimensions are shown: Inch (mm)
Specifications and dimensions subject to change

C&K Y Series 4, 5 & 6 Tumbler Switchlocks

SWITCH AND LOCK FUNCTION



NO. TUMBLERS	NO. POLES	MODEL NO.	CONNECTED TERMINALS				KEY PULL POSITIONS	LOCK CONFIGURATION	INDEXING
			POS. 1	POS. 2	POS. 3	POS. 4			
4	SP	Y19073	C-1	C-2	C-4	Position 1	POS. 1 ● 3 — 2	90°	
		Y1907U					POS. 1 ● 3 — 2		
		Y1900S	C-1	C-2	C-3	C-4	Positions 1, 2, 3 & 4		POS. 1 ● 4 ● 2 ● 3

LEGEND

- = Detent Positions (45° or 90°)
- ⊙ = Key pull possible in these positions.
- ⊙ = Stop Positions



TERMINAL NUMBERS



Terminal numbers marked on insulator.

All models with all options when ordered with 'G' or 'Q' contact material.

NOTE: Epoxy seal not available. Removable dress nut not available with any Y190XX models.

4 & 5 Tumbler



6 Tumbler



Dimensions are shown: Inch (mm)
Specifications and dimensions subject to change

C&K Y Series 4, 5 & 6 Tumbler Switchlocks

SWITCH AND LOCK FUNCTION



AVAILABLE OPTION COMBINATIONS															
MODELS	LOCK TYPES						TERMINATIONS					MOUNTING/LOCK STYLES			
	A	B	C	R	V	W	01	02	03	07	WC	D	L	N	R
YX0013		•	•		•	•	•	•	•		•	•		•	•
YX001U		•	•	•	•	•	•	•	•		•	•	•	•	•
YX0082		•	•	•			•	•	•		•	•		•	
YX00AX			•	•			•	•	•		•	•		•	•
YX0113		•	•	•	•	•	•	•	•		•	•		•	•
YX011C		•	•	•			•	•	•		•	•		•	•
YX011U		•	•	•	•	•	•	•	•		•	•	•	•	•
Y141XX			•	•			•	•	•		•	•		•	•
YX0812	•						•	•	•		•	•		•	•
Y190XX			•	•				•		•	•	•		•	•

KEYING



OPTION CODE	KEYING OPTIONS	CODE NO. ON KEY	CODE NO. ON LOCK
2	2 NICKEL PLATED BRASS KEYS (4 & 5 TUMBLER) or 2 DIE CAST CHROME PLATED ZINC ALLOY KEYS (6 TUMBLER)	YES	NO
6	2 NICKEL PLATED BRASS KEYS, 4 & 5 TUMBLER ONLY	YES	YES

NOTE: All orders keyed alike, standard. For more than one key code, master keying, replacement keys, or other special features, consult Customer Service Center.

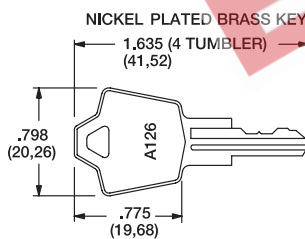

Key part number: 115140126

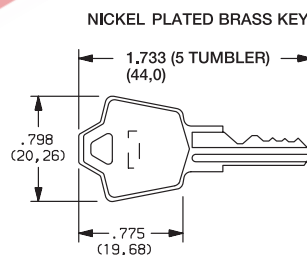

Key part number: 115441001

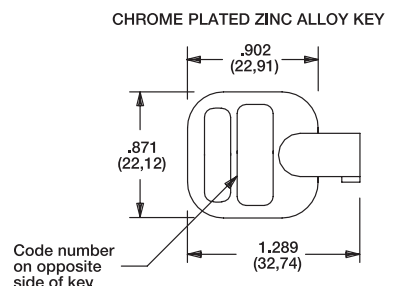

Key part number: 363C1AAAA

NOTE: Keys are available separately, see page M-10. Key head shape subject to change without notice.

LOCK TYPE



C 4 TUMBLER LOCK WITH DETENT

V 6 TUMBLER TUBULAR LOCK

A 4 TUMBLER LOCK (MOMENTARY MODELS ONLY)

B 5 TUMBLER LOCK

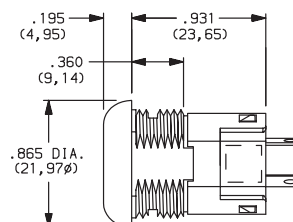
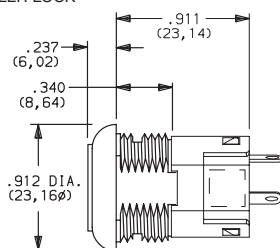

Available with Lock Finish '2' only

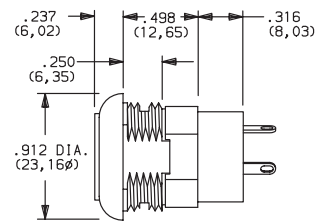

Dimensions are shown: Inch (mm)
Specifications and dimensions subject to change



C&K Y Series 4, 5 & 6 Tumbler Switchlocks

LOCK TYPE

SHORT ANTI-STATIC LOCK TYPES

R 4 TUMBLER LOCK WITH DETENT AND SHORT ANTI-STATIC SWITCH.

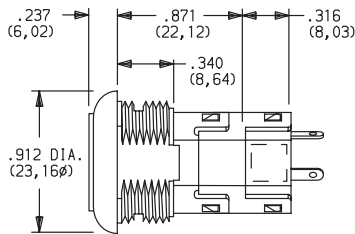

W 6 TUMBLER TUBULAR LOCK WITH ANTI-STATIC SWITCH

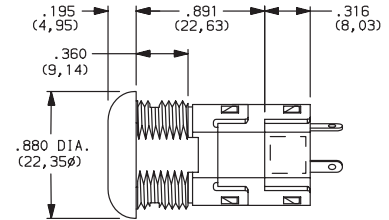

Available with Lock Finish '2' only.

NOTE: For available option combinations, see page M-9.
U.S. Pat. No. 4,639,562 Exceeds 20 KV DC static resistance @ sea level, lock body to terminals.

LOCK FINISH

2 STAINLESS STEEL

8 GLOSS BLACK

F POLISHED NICKEL



Available with Lock Types 'V' & 'W' only.

NOTE: For available option combinations, see page M-9.

TERMINATIONS

03 SOLDER LUG WITH HOLE

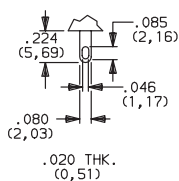

01 SOLDER LUG WITH NOTCH

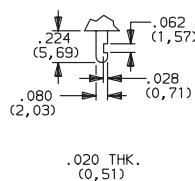

02 PC THRU-HOLE

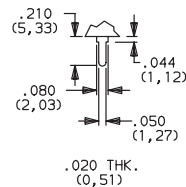

WC WIRE LEAD

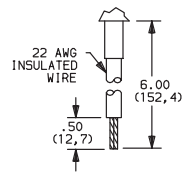

Black wire standard. other colors and lengths available, consult Customer Service Center. UL style 1015.

All Models Except Y190

02 PC THRU-HOLE



07 SOLDER LUG WITH HOLE



WC WIRE LEAD

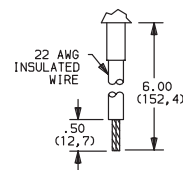

Black wire standard. other colors and lengths available, consult Customer Service Center. UL style 1015.

PC MOUNTING

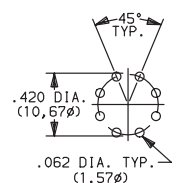

Y190 Model Only



Dimensions are shown: Inch (mm)
Specifications and dimensions subject to change

C&K Y Series 4, 5 & 6 Tumbler Switchlocks

MOUNTING/LOCK STYLE

N WITH NUT



Nut part number: 175050700

D WITH CLIP



Clip part number: 906B00000

PANEL MOUNTING



OPTION CODE	MOUNTING STYLE	PANEL THICKNESS
N	WITH NUT	.085-.105 (2,16-2,67)
D	WITH CLIP	.085-.105 (2,16-2,67)

R REMOVABLE DRESS NUT

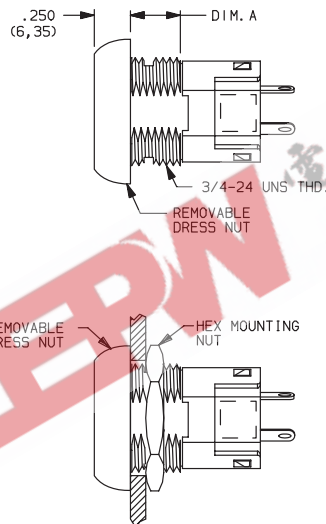
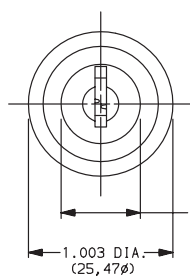

PANEL MOUNTING

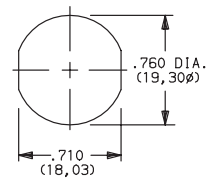

LOCK DIMENSIONS	
LOCK TYPES	DIMENSIONS 'A'
A, N	.270 (6,68)
C, R	.360 (9,14)

TYPICAL INSTALLATION

Install hex nut with enough clearance to allow for dress nut and panel. Place switch through cutout in rear of panel. Install and tighten dress nut by hand, then tighten hex nut. Always tighten assembly with back of panel hex nut to avoid damaging front of panel.

NOTE: Removable dress nut not available with Y1900A model.

L REMOVABLE DRESS NUT WITH LATCH PAWL



Latch pawl shown in pos. 1.

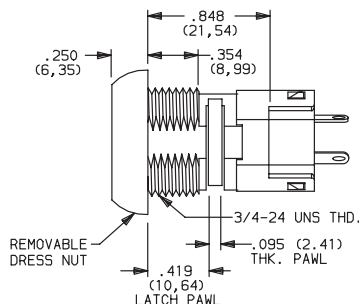

PANEL MOUNTING

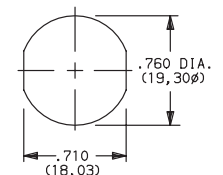
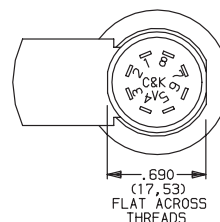

Dimensions are shown: Inch (mm)
Specifications and dimensions subject to change



M

Switchlock

C&K Y Series 4, 5 & 6 Tumbler Switchlocks

MOUNTING/LOCK STYLE

Mounting Information (All Models)

PANEL THICKNESS			
MOUNTING STYLES	A, B LOCK TYPES	C, R LOCK TYPES	V, W LOCK TYPES
D	.065-.085 (1, 65-2, 16)		.085-.105 (2, 16-2, 67)
N	.105 (2, 67) max.	.195 (4, 95) max.	.215 (5, 46) max.
L	.215 (5, 46) max.		-
R	.125 (3, 18) max.	.215 (5, 46) max.	-

AVAILABLE OPTION COMBINATIONS									
MOUNTING STYLES	LOCK FINISHES			LOCK TYPES					
	2	8	F	A	B	C	R	V	W
D	●	●	●	●	●	●	●	●	●
N	●	●	●	●	●	●	●	●	●
R		●	●	●		●	●		
L		●	●			●	●		

CONTACT MATERIAL

OPTION CODE	RoHS COMPLIANT*	RoHS COMPATIBLE*	CONTACT AND TERMINAL MATERIAL	RATING	
Q	YES	YES	SILVER ²	POWER	4 AMPS @ 125 V AC or 28 V DC; 2 AMPS @ 250 AC V AC (UL/CSA).
B	YES	YES	GOLD ¹	LOW LEVEL/DRY CIRCUIT	0.4 VA MAX. @ 20 V AC or DC MAX
G	YES	YES	GOLD SILVER ³	LOW LEVEL/DRY CIRCUIT OR POWER	0.4 VA MAX. @ 20 V AC or DC MAX. or 4 AMPS @ 125 V AC or 28 V DC; 2 AMPS @ 250 V AC (UL/CSA)

* Note: See Technical Data section of this catalog for RoHS compliant and compatible definitions and specifications.

¹ CONTACTS & TERMINALS: Copper, with gold plate over nickel plate.

² CONTACTS & TERMINALS: Copper, silver plated (std. with all termination options).

³ CONTACTS & TERMINALS: Copper, with gold plate over silver plate.

All models   with all options when ordered with 'G' or 'Q' contact material.

SEAL

NONE NO SEAL

E EPOXY SEAL



Dimensions are shown: Inch (mm)
Specifications and dimensions subject to change

C&K Y Series 4, 5 & 6 Tumbler Switchlocks

AVAILABLE HARDWARE



Key Code: A126
4 TUMBLER
PART NO. (ONE KEY)
115140126
Material: Brass
Finish: Nickel plate

Key Code: D001
5 TUMBLER
PART NO. (ONE KEY)
115441001
Material: Brass
Finish: Nickel plate



Key Code: AAAA
PART NO. (ONE KEY)
363C1AAAA

Material: Zinc alloy
Finish: Chrome plate

EEPW 电子產品世界 .com.cn



Switchlock



Dimensions are shown: Inch (mm)
Specifications and dimensions subject to change