

XTR103

4-20mA Current Transmitter with RTD EXCITATION AND LINEARIZATION

FEATURES

- LESS THAN $\pm 1\%$ TOTAL ADJUSTED ERROR, -40°C TO $+85^{\circ}\text{C}$
- RTD EXCITATION AND LINEARIZATION
- TWO OR THREE-WIRE RTD OPERATION
- WIDE SUPPLY RANGE: 9V to 40V
- HIGH PSR: 110dB min
- HIGH CMR: 80dB min

APPLICATIONS

- INDUSTRIAL PROCESS CONTROL
- FACTORY AUTOMATION
- SCADA

DESCRIPTION

The XTR103 is a monolithic 4-20mA, two-wire current transmitter designed for Platinum RTD temperature sensors. It provides complete RTD current excitation, instrumentation amplifier, linearization, and current output circuitry on a single integrated circuit.

Versatile linearization circuitry provides a 2nd-order correction to the RTD, typically achieving a 40:1 improvement in linearity.

Instrumentation amplifier gain can be configured for a wide range of temperature measurements. Total adjusted error of the complete current transmitter, including the linearized RTD is less than $\pm 1\%$ over the full -40 to $+85^{\circ}\text{C}$ operating temperature range. This includes zero drift, span drift and nonlinearity. The XTR103 operates on loop power supply voltages down to 9V.

The XTR103 is available in 16-pin plastic DIP and SOL-16 surface-mount packages specified for the -40°C to $+85^{\circ}\text{C}$ temperature range.

Pt100 NONLINEARITY CORRECTION USING XTR103

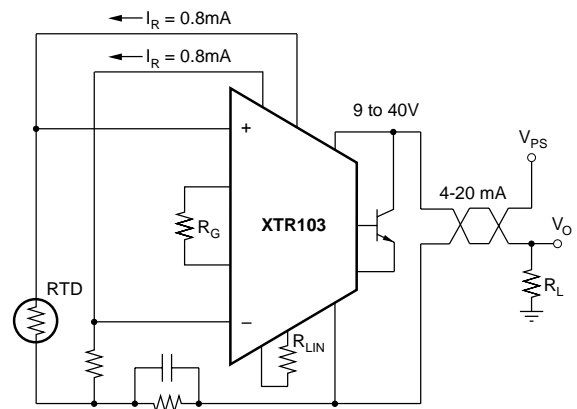
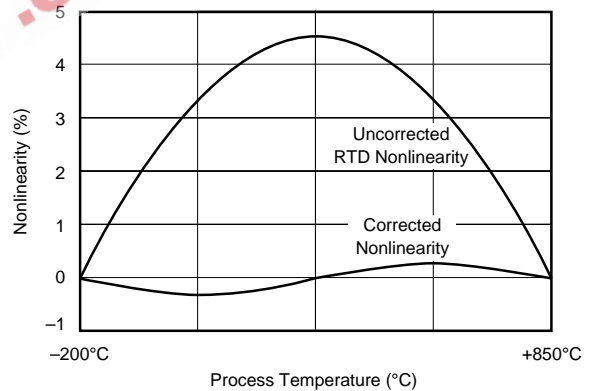

SPECIFICATIONS

ELECTRICAL

At $T_A = +25^\circ\text{C}$, $V_+ = 24\text{V}$, and 2N6121 external transistor, unless otherwise noted.

PARAMETER	CONDITIONS	XTR103BP/BU			XTR103AP/AU			UNITS
		MIN	TYP	MAX	MIN	TYP	MAX	
OUTPUT Output Current Equation Total Adjusted Error ⁽¹⁾ Output Current, Specified Range Over-Scale Limit Under Scale-Limit Full Scale Output Error Noise: 0.1Hz to 1kHz	T_{MIN} to T_{MAX} $V_{\text{IN}} = 1\text{V}$, $R_G = \infty$ $R_G = 40\Omega$	$I_O = V_{\text{IN}} \cdot (0.016 + 40/R_G) + 4\text{mA}$, V_{IN} in Volts, R_G in Ω						A % of FS mA mA mA μA $\mu\text{A/p-p}$
ZERO OUTPUT ⁽²⁾ Initial Error vs Temperature vs Supply Voltage, V_+ vs Common-Mode Voltage	$V_{\text{IN}} = 0$, $R_G = \infty$ $V_+ = 9\text{V}$ to 40V ⁽³⁾ $V_{\text{CM}} = 2\text{V}$ to 4V ⁽³⁾		4 ± 5 ± 0.2 0.5 0.1	± 1 ± 50 ± 0.5 2 2		*	*	mA μA $\mu\text{A}/^\circ\text{C}$ $\mu\text{A/V}$ $\mu\text{A/V}$
SPAN Span Equation (Transconductance) Untrimmed Error vs Temperature ⁽⁴⁾ Nonlinearity: Ideal Input RTD Input	$R_G \geq 75\Omega$ Pt100: -200°C to $+850^\circ\text{C}$ $R_{\text{LIN}} = 1127\Omega$			$S = 0.016 + 40/R_G$ ± 0.1 ± 20 ± 50 0.01 0.1		*	*	A/V % ppm/ $^\circ\text{C}$ % %
INPUT Differential Range Input Voltage Range ⁽³⁾ Common-Mode Rejection Impedance: Differential Common-Mode Offset Voltage vs Temperature vs Supply Voltage, V_+ Input Bias Current vs Temperature Input Offset Current vs Temperature	$R_G = \infty$ $V_{\text{IN}} = 2\text{V}$ to 4V ⁽³⁾ $V_+ = 9\text{V}$ to 40V ⁽³⁾	2 80	100 3 0.5 ± 0.5 ± 1 100 0.1 2 0.01	4 4 3 ± 2.5 ± 2.5 250 2 20 0.25		*	*	V V dB G Ω G Ω mV $\mu\text{V}/^\circ\text{C}$ dB nA nA/ $^\circ\text{C}$ nA nA/ $^\circ\text{C}$
CURRENT SOURCES ⁽⁵⁾ Current Accuracy vs Temperature vs Power Supply, V_+ Compliance Voltage ⁽³⁾ Matching vs Temperature vs Power Supply, V_+	$V_+ = 9\text{V}$ to 40V ⁽³⁾ $V_+ = 9\text{V}$ to 40V ⁽³⁾		0.8 ± 0.25 ± 25 50 $(V_{\text{IN}}^-) - 0.2$ ± 10 10	± 0.5 ± 50 $(V_+) - 5$ ± 0.5 ± 25		*	*	mA % ppm/ $^\circ\text{C}$ ppm/V V % ppm/ $^\circ\text{C}$ ppm/V
POWER SUPPLY Voltage Range ⁽³⁾ , V_+		9		40		*	*	V
TEMPERATURE RANGE Specification, T_{MIN} to T_{MAX} Operating θ_{JA}		-40 -40		85 125		*	*	$^\circ\text{C}$ $^\circ\text{C}$ $^\circ\text{C/W}$

* Specification same as XTR103BP.

NOTES: (1) Includes corrected Pt100 nonlinearity for process measurement spans greater than 100°C , and over-temperature zero and span effects. Does not include initial offset and gain errors which are normally trimmed to zero at 25°C . (2) Describes accuracy of the 4mA low-scale offset current. Does not include input amplifier effects. Can be trimmed to zero. (3) Voltage measured with respect to I_O pin. (4) Does not include TCR of gain-setting resistor, R_G . (5) Measured with $R_{\text{LIN}} = \infty$ to disable linearization feature.

PIN CONFIGURATION

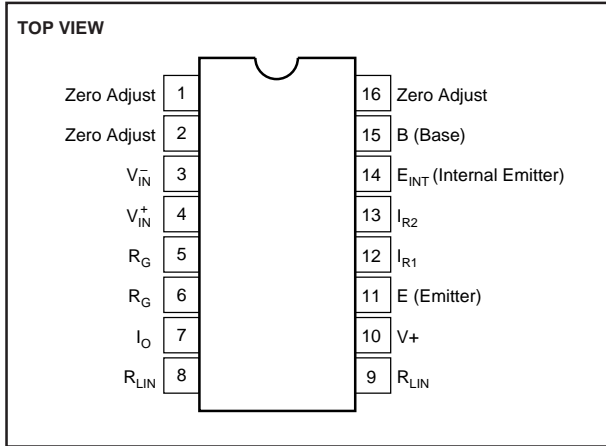

PACKAGE/ORDERING INFORMATION

PRODUCT	PACKAGE	PACKAGE DRAWING NUMBER ⁽¹⁾	TEMPERATURE RANGE
XTR103AP	16-pin Plastic DIP	180	-40°C to +85°C
XTR103BP	16-pin Plastic DIP	180	-40°C to +85°C
XTR103AU	SOL-16 Surface Mount	211	-40°C to +85°C
XTR103BU	SOL-16 Surface Mount	211	-40°C to +85°C

NOTE: (1) For detailed drawing and dimension table, please see end of data sheet, or Appendix C of Burr-Brown IC Data Book.

ABSOLUTE MAXIMUM RATINGS

Power Supply, V+ (referenced to I_O pin)	40V
Input Voltage, V_{IN}^+ , V_{IN}^- (referenced to I_O pin)	0V to V+
Storage Temperature Range	-55°C to +125°C
Lead Temperature (soldering, 10s)	+300°C
Output Current Limit	Continuous
Junction Temperature	+165°C



ELECTROSTATIC DISCHARGE SENSITIVITY

This integrated circuit can be damaged by ESD. Burr-Brown recommends that all integrated circuits be handled with appropriate precautions. Failure to observe proper handling and installation procedures can cause damage.

ESD damage can range from subtle performance degradation to complete device failure. Precision integrated circuits may be more susceptible to damage because very small parametric changes could cause the device not to meet its published specifications.

The information provided herein is believed to be reliable; however, BURR-BROWN assumes no responsibility for inaccuracies or omissions. BURR-BROWN assumes no responsibility for the use of this information, and all use of such information shall be entirely at the user's own risk. Prices and specifications are subject to change without notice. No patent rights or licenses to any of the circuits described herein are implied or granted to any third party. BURR-BROWN does not authorize or warrant any BURR-BROWN product for use in life support devices and/or systems.

TYPICAL PERFORMANCE CURVES

At $T_A = +25^\circ\text{C}$, $V_+ = 24\text{VDC}$, unless otherwise noted.

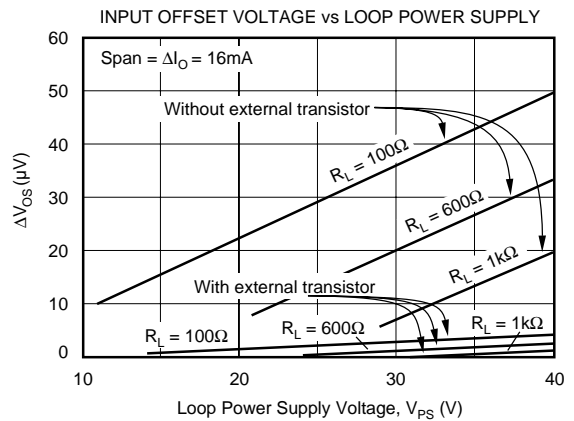
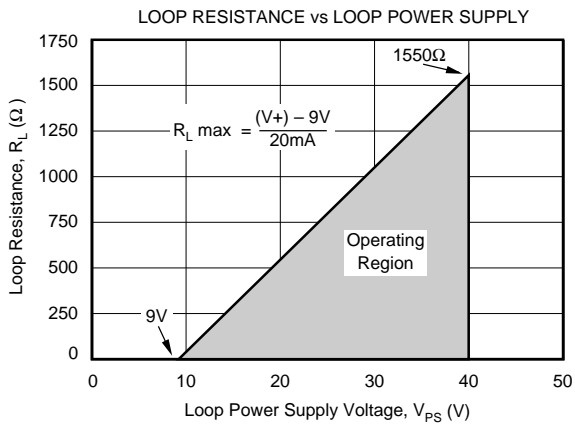
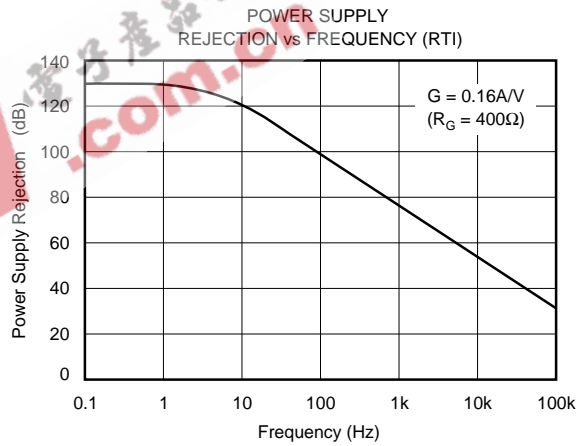
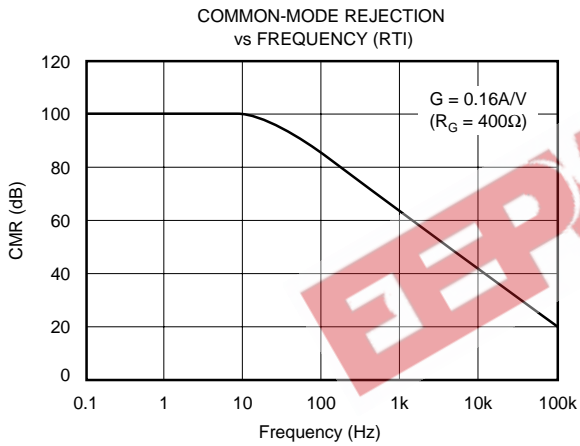
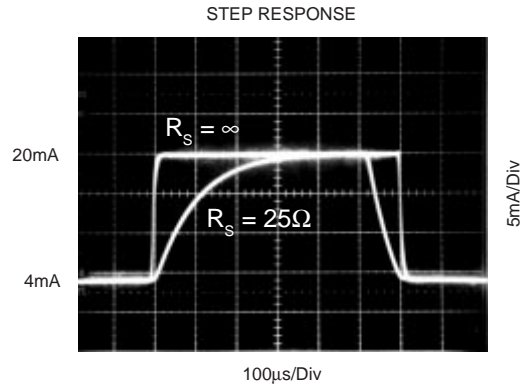
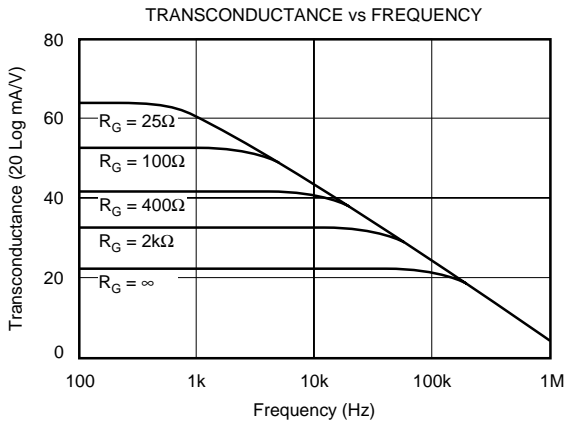

TYPICAL PERFORMANCE CURVES (CONT)

At $T_A = +25^\circ\text{C}$, $+V = 24\text{VDC}$, unless otherwise noted.

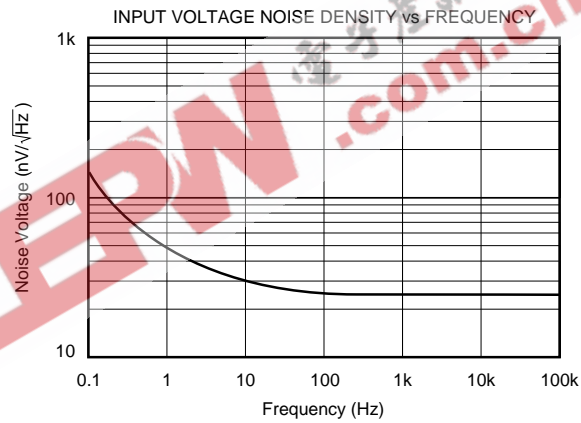
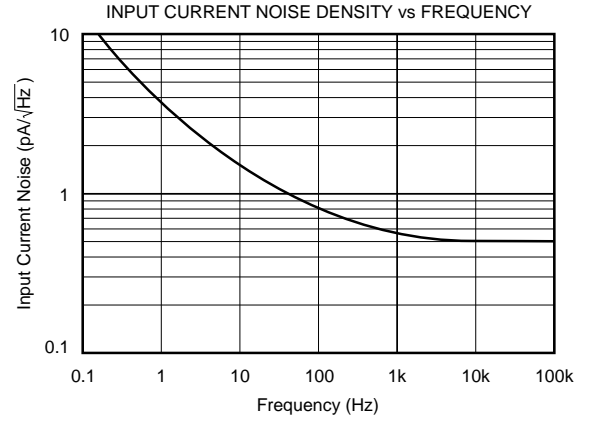
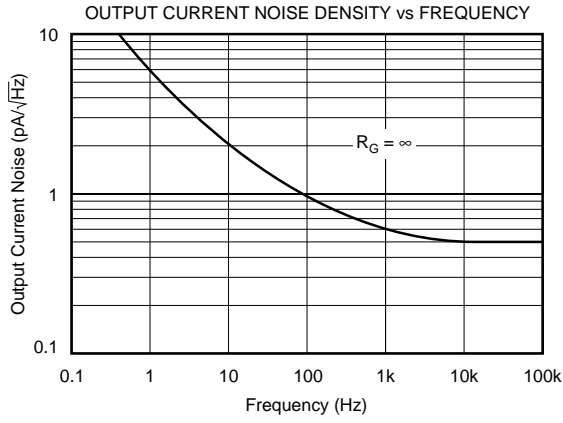

APPLICATION INFORMATION

Figure 1 shows the basic connection diagram for the XTR103. The loop power supply, V_{PS} provides power for all circuitry. Output loop current is measured as a voltage across the series load resistor, R_L .

Two matched 0.8mA current sources drive the RTD and zero-setting resistor, R_Z . The instrumentation amplifier input of the XTR103 measures the voltage difference between the RTD and R_Z . The value of R_Z is chosen to be equal to the resistance of the RTD at the low-scale (minimum) measurement temperature. R_Z can be adjusted to achieve 4mA output at the minimum measurement temperature to correct for input offset voltage and reference current mismatch of the XTR103.

R_{CM} provides an additional voltage drop to bias the inputs of the XTR103 within their common-mode range. Resistor, R_G , sets the gain of the instrumentation amplifier according to the desired temperature measurement range.

The transfer function through the complete instrumentation amplifier and voltage-to-current converter is:

$$I_O = V_{IN} \cdot (0.016 + 40/R_G) + 4mA,$$

(V_{IN} in volts, R_G in ohms, $R_{LIN} = \infty$)

where V_{IN} is the differential input voltage. With no R_G connected ($R_G = \infty$), a 0V to 1V input produces a 4-20mA output current. With $R_G = 25\Omega$, a 0V to 10mV input produces a 4-20mA output current. Other values for R_G can be calculated according to the desired full-scale input voltage, V_{FS} , with the formula in Figure 1.

Negative input voltage, V_{IN} , will cause the output current to be less than 4mA. Increasingly negative V_{IN} will cause the output current to limit at approximately 3.6mA.

Increasingly positive input voltage (greater than V_{FS}) will produce increasing output current according to the transfer function, up to the output current limit of approximately 34mA.

EXTERNAL TRANSISTOR

Transistor Q_1 conducts the majority of the signal-dependent 4-20mA loop current. Using an external transistor isolates the majority of the power dissipation from the precision input and reference circuitry of the XTR103, maintaining excellent accuracy.

Since the external transistor is inside a feedback loop its characteristics are not critical. Requirements are: $V_{CEO} = 45V$ min, $\beta = 40$ min and $P_D = 800mW$. Power dissipation requirements may be lower if the loop power supply voltage is less than 40V. Some possible choices for Q_1 are listed in Figure 1.

The XTR103 can be operated without this external transistor by connecting pin 11 to 14 (see Figure 2). Accuracy will be somewhat degraded by the additional internal power dissipation. This effect is most pronounced when the input stage is set for high gain (for low full-scale input voltage). The typical performance curve "Input Offset Voltage vs Loop Supply Voltage" describes this behavior.

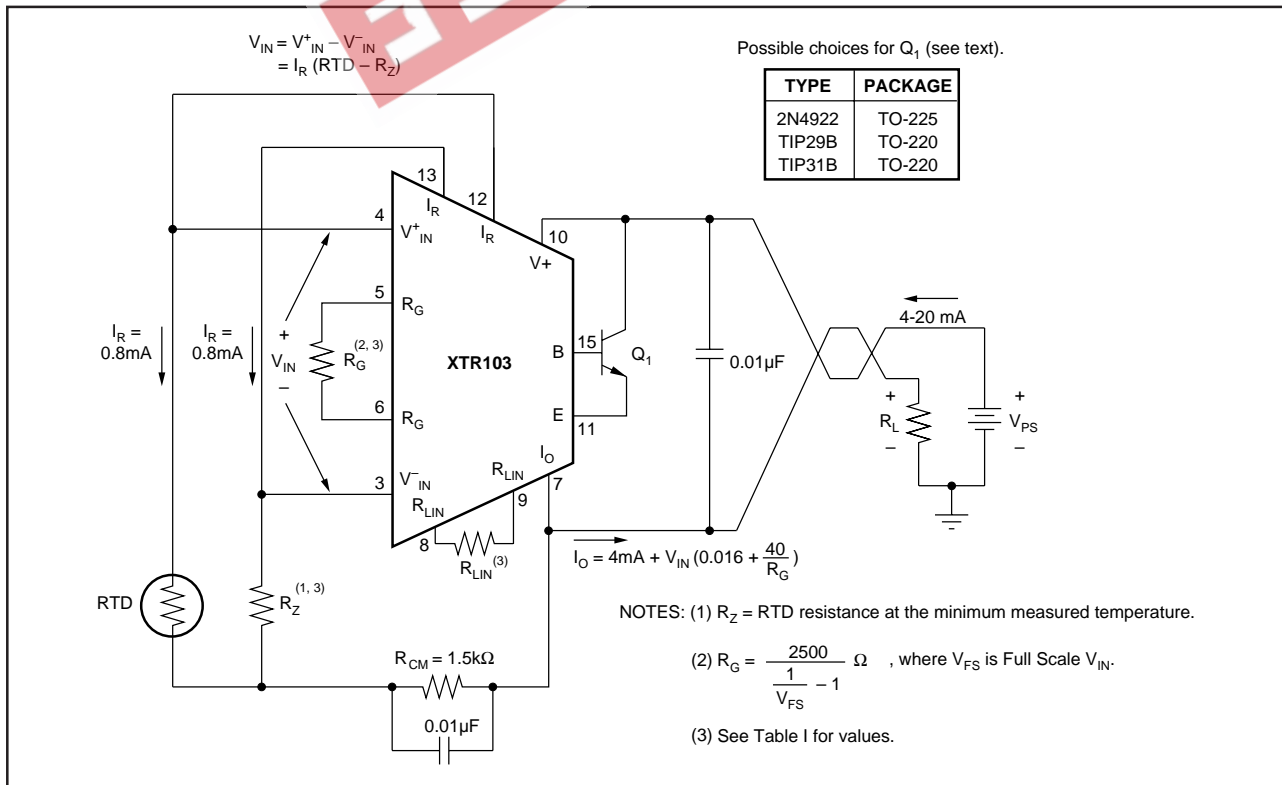

FIGURE 1. Basic RTD Temperature Measurement Circuit.

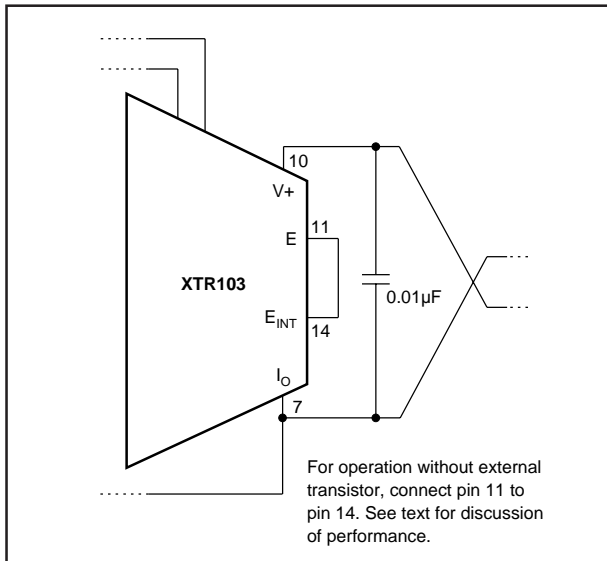

FIGURE 2. Operation Without External Transistor.

LOOP POWER SUPPLY

The voltage applied to the XTR103, V+, is measured with respect to the I_O connection, pin 7. V+ can range from 9V to 40V. The loop supply voltage, V_{PS}, will differ from the voltage applied to the XTR103 according to the voltage drop on the current sensing resistor, R_L (plus any other voltage drop in the line).

If a low loop supply voltage is used, R_L must be made a relatively low value to assure that V+ remains 9V or greater for the maximum loop current of 20mA. It may, in fact, be prudent to design for V+ equal or greater than 9V with loop currents up to 34mA to allow for out-of-range input conditions. The typical performance curve "Loop Resistance vs Loop Power Supply" shows the allowable sense resistor values for full-scale 20mA.

The low operating voltage (9V) of the XTR103 allows operation directly from personal computer power supplies (12V ±5%). When used with the RCV420 Current Loop Receiver (Figure 8), load resistor voltage drop is limited to 1.5V.

LINEARIZATION

On-chip linearization circuitry creates a signal-dependent variation in the two matching current sources. Both current sources are varied equally according to the following equation:

$$I_{R1} = I_{R2} = 0.8 + \frac{500 \cdot V_{IN}}{R_{LIN}}$$

(I_R in mA, V_{IN} in volts, R_{LIN} in ohms)
(maximum I_R = 1.0mA)

This varying excitation provides a 2nd-order term to the transfer function (including the RTD) which can correct the RTD's nonlinearity. The correction is controlled by resistor R_{LIN} which is chosen according to the desired temperature measurement range. Table I provides the R_G, R_Z and R_{LIN} resistor values for a Pt100 RTD.

If no linearity correction is desired, do not connect a resistor to the R_{LIN} pins (R_{LIN} = ∞). This will cause the excitation current sources to remain a constant 0.8mA.

ADJUSTING INITIAL ERRORS

Most applications will require adjustment of initial errors. Offset errors can be corrected by adjustment of the zero resistor, R_Z.

Figure 3 shows another way to adjust zero errors using the output current adjustment pins of the XTR103. This provides a minimum of ±300µA (typically ±500µA) adjustment around the initial low-scale output current. This is an output current adjustment which is independent of the input stage gain set

MEASUREMENT TEMPERATURE SPAN ΔT (°C)										
T _{MIN}	100°C	200°C	300°C	400°C	500°C	600°C	700°C	800°C	900°C	1000°C
-200°C	18/90 653	18/185 838	18/286 996	18/396 1087	18/515 1131	18/645 1152	18/788 1159	18/946 1158	18/1120 1154	18/1317 1140
-100°C	60/84 1105	60/173 1229	60/270 1251	60/374 1249	60/487 1231	60/610 1207	60/746 1181	60/895 1155	60/1061 1128	
0°C	100/81 1287	100/167 1258	100/260 1229	100/361 1201	100/469 1173	100/588 1145	100/718 1117	100/860 1089		
100°C	138/78 1211	138/162 1183	138/252 1155	138/349 1127	138/453 1100	138/567 1073	138/691 1046			
200°C	175/76 1137	175/157 1110	175/244 1083	175/337 1056	175/437 1030	175/546 1003				
300°C	212/73 1066	212/152 1039	212/235 1013	212/325 987	212/422 962					
400°C	247/71 996	247/146 971	247/227 946	247/313 921						
500°C	280/68 930	280/141 905	280/219 881							
600°C	313/66 865	313/136 841								
700°C	345/64 803									
800°C	375/61 743									

R_Z/R_G
R_{LIN} (Values are in Ω.)

NOTE: Values shown are for a Pt100 RTD.
Double (x2) all values for Pt200.

TABLE I. R_Z, R_G, and R_{LIN} Resistor Values for Pt100 RTD.

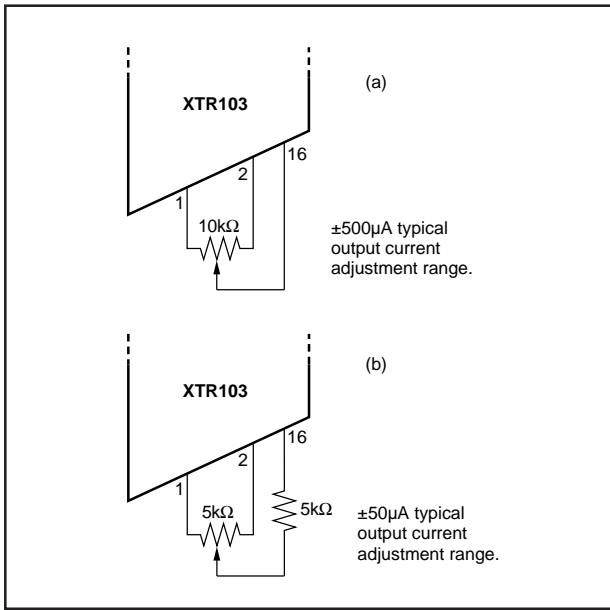

FIGURE 3. Low-Scale Output Current Adjustment.

with R_G . If the input stage is set for high gain (as required with narrow temperature measurement spans) the output current adjustment may not provide sufficient range. In these cases, offset can be nulled by adjusting the value of R_Z .

TWO-WIRE AND THREE-WIRE RTD CONNECTIONS

In Figure 1, the RTD can be located remotely simply by extending the two connections to the RTD. With this two-wire connection to the RTD, line resistance will introduce error. This error can be partially corrected by adjusting the values of R_Z , R_G , and R_{LIN} .

Figure 4, shows a three-wire RTD connection for improved accuracy with remotely located RTDs. R_Z 's current is routed through a third wire to the RTD. Assuming line resistance is equal in RTD lines 1 and 2, this produces a small common-mode voltage which is rejected by the XTR103.

OPEN-CIRCUIT DETECTION

The optional transistor Q_2 in Figure 4 provides predictable behavior with open-circuit RTD connections. It assures that if any one of the three RTD connections is broken, the XTR103's output current will go to either its high current limit ($\approx 34\text{mA}$) or low current limit ($\approx 3.6\text{mA}$). This is easily detected as an out-of-range condition.

REVERSE-VOLTAGE PROTECTION

Figure 5 shows two ways to protect against reversed output connection lines. Trade-offs in an application will determine which technique is better. D_1 offers series protection, but causes a 0.7V loss in loop supply voltage. This may be undesirable if V_+ can approach the 9V limit. Using D_2 (without D_1) has no voltage loss, but high current will flow in the loop supply if the leads are reversed. This could damage the power supply or the sense resistor, R_L . A diode with a higher current rating is needed for D_2 to withstand the highest current that could occur with reversed lines.

SURGE PROTECTION

Long lines are subject to voltage surges which can damage semiconductor components. To avoid damage, the maximum applied voltage rating for the XTR103 is 40V. A zener diode may be used for D_2 (Figure 6) to clamp the voltage applied to the XTR103 to a safe level. The loop power supply voltage must be lower than the voltage rating of the zener diode.

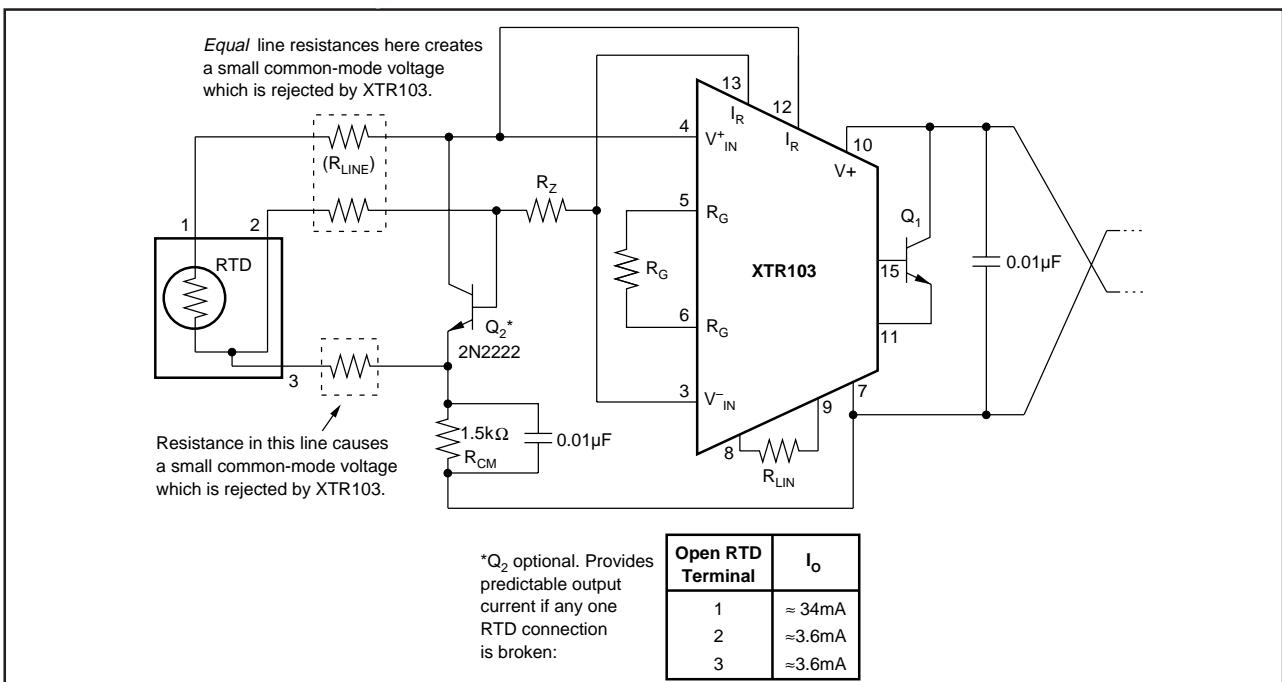

FIGURE 4. Three-Wire Connection for Remotely Located RTDs.

There are special zener diode types specifically designed to provide a very low impedance clamp and withstand large energy surges. These devices normally have a diode characteristic in the forward direction which also protects against reversed loop connections. As noted earlier, reversed loop connections would produce a large loop current, possibly damaging R_L .

RADIO FREQUENCY INTERFERENCE

The long wire lengths of current loops invite radio frequency interference. RF can be rectified by the sensitive input circuitry of the XTR103 causing errors. This generally appears as an unstable output current that varies with the position of loop supply or input wiring.

If the RTD sensor is remotely located, the interference may enter at the input terminals. For integrated transmitter assemblies with short connection to the sensor, the interference more likely comes from the current loop connections.

Bypass capacitors on the input often reduce or eliminate this interference. Connect these bypass capacitors to the I_O terminal as shown in Figure 7. Although the DC voltage at the I_O terminal is not equal to 0V (at the loop supply, V_{PS}) this circuit point can be considered the transmitter's "ground."

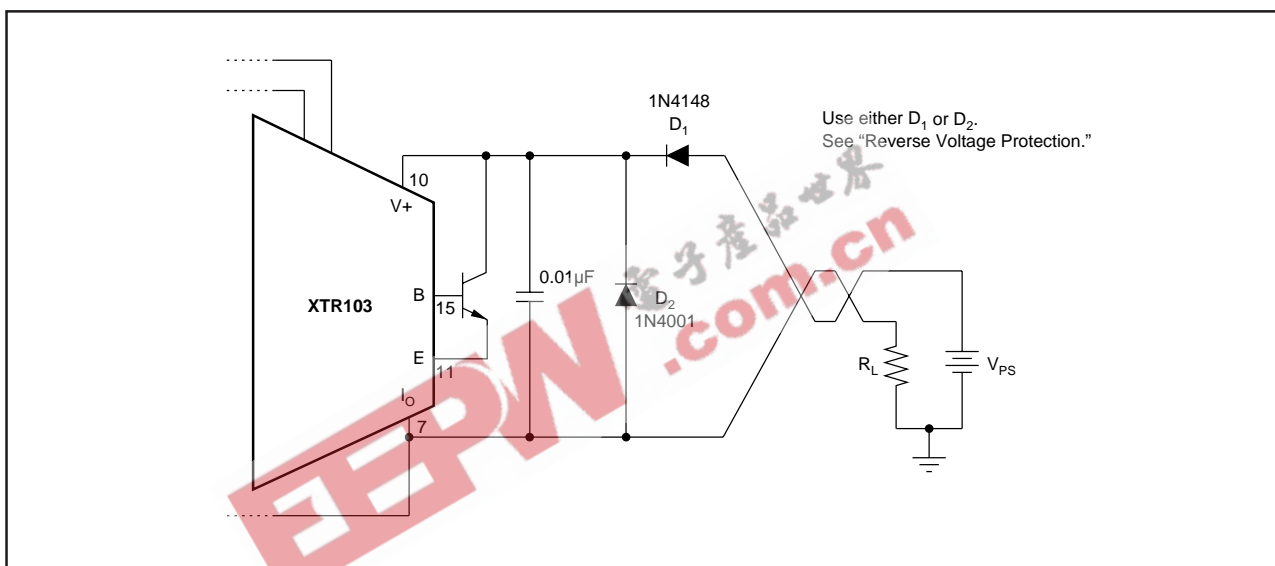

FIGURE 5. Reverse Voltage Protection.

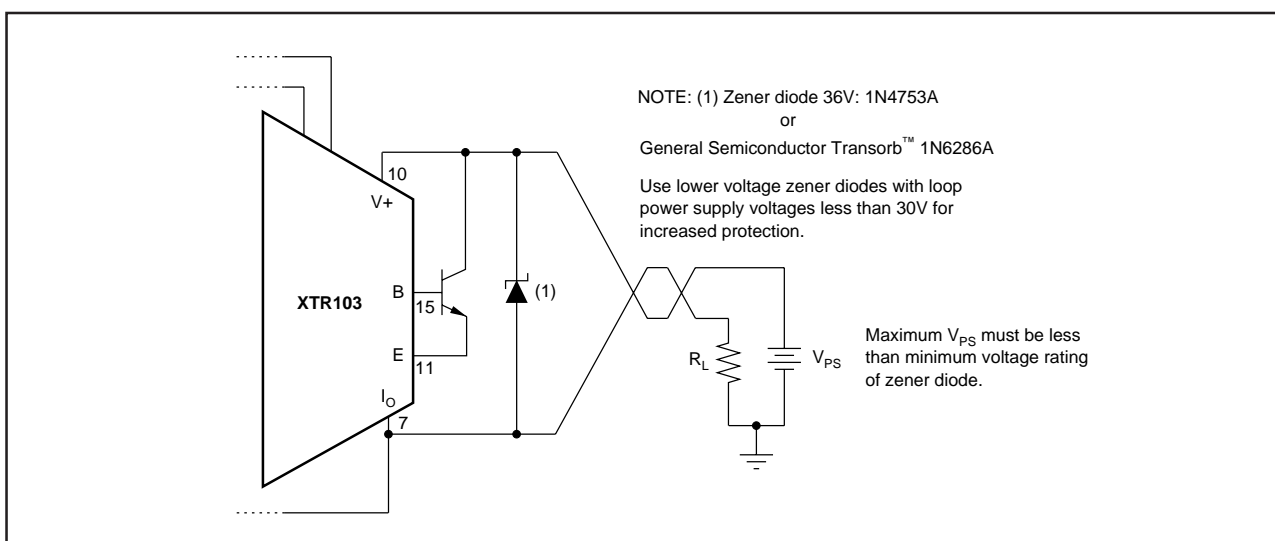

FIGURE 6. Over-Voltage Surge Protection.

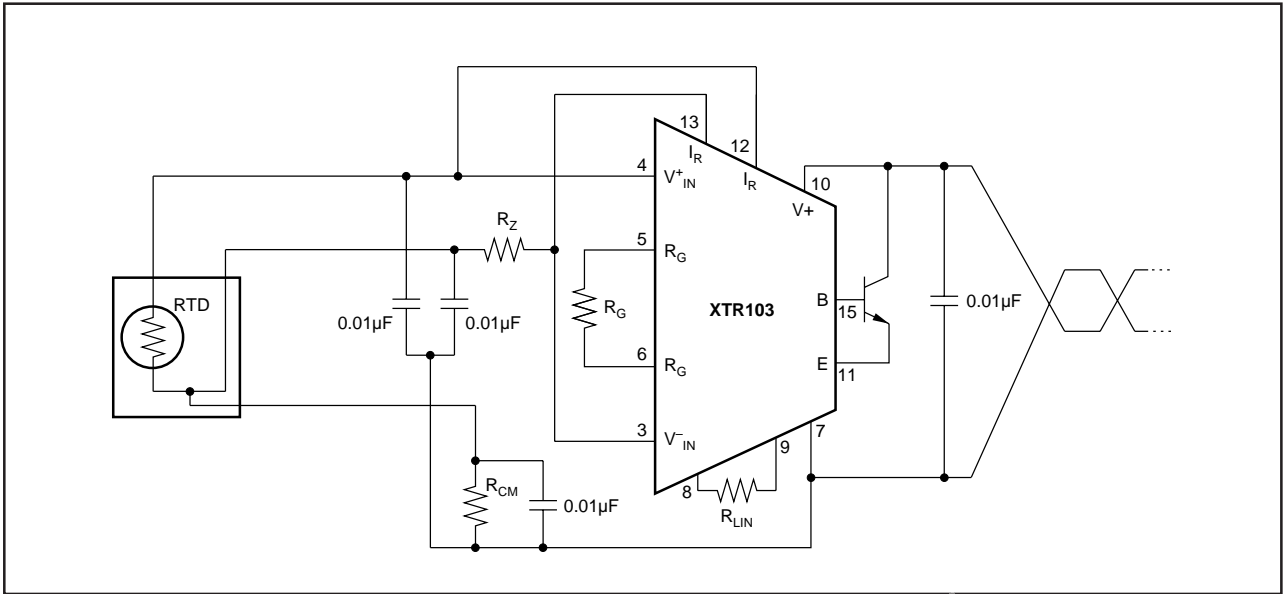

FIGURE 7. Input Bypassing Techniques.

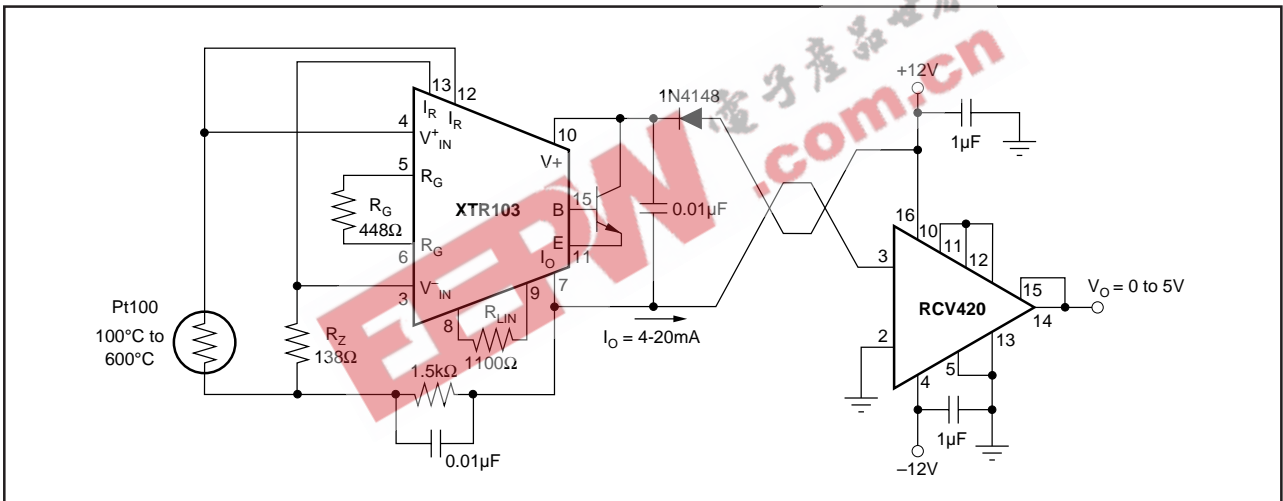

FIGURE 8. ±12V-Powered Transmitter/Receiver Loop.

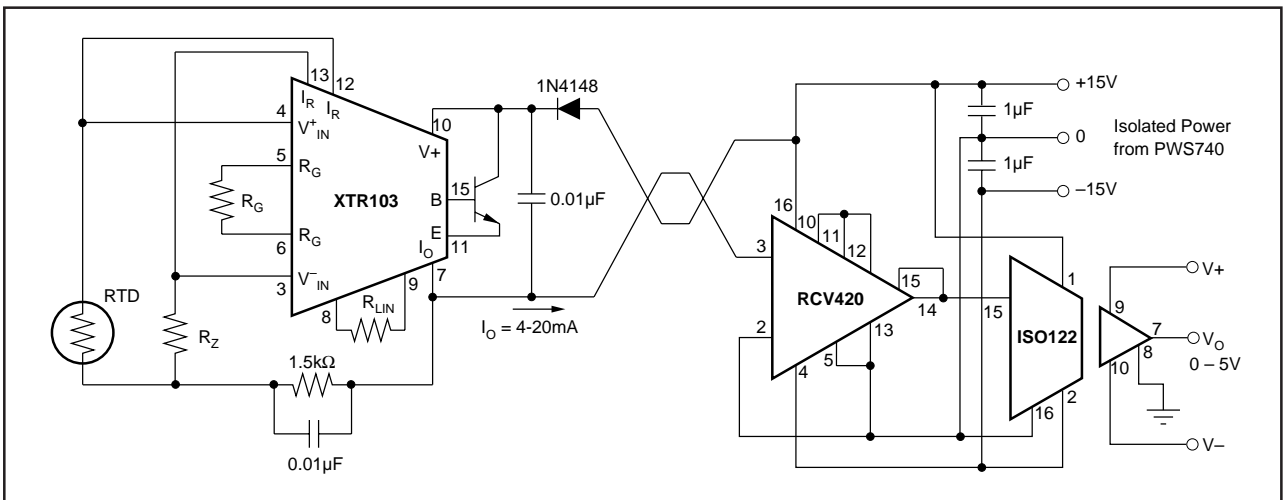

FIGURE 9. Isolated Transmitter/Receiver Loop.