



XTR104

4-20mA Current Transmitter with BRIDGE EXCITATION AND LINEARIZATION

FEATURES

- LESS THAN $\pm 1\%$ TOTAL ADJUSTED ERROR, -40°C TO $+85^{\circ}\text{C}$
- BRIDGE EXCITATION AND LINEARIZATION
- WIDE SUPPLY RANGE: 9V to 40V
- LOW SPAN DRIFT: 50ppm/ $^{\circ}\text{C}$ max
- HIGH PSR: 110dB min
- HIGH CMR: 80dB min

DESCRIPTION

The XTR104 is a monolithic 4-20mA, two-wire current transmitter integrated circuit designed for bridge input signals. It provides complete bridge excitation, instrumentation amplifier, linearization, and current output circuitry necessary for high impedance strain gage sensors.

The instrumentation amplifier can be used over a wide range of gain, accommodating a variety of input signals and sensors. Total adjusted error of the complete current transmitter, including the linearized bridge is less than $\pm 1\%$ over the full -40°C to $+85^{\circ}\text{C}$ temperature range. This includes zero drift, span drift and non-linearity for bridge outputs as low as 10mV. The XTR104 operates on loop power supply voltages down to 9V.

Linearization circuitry consists of a second, fully independent instrumentation amplifier that controls the bridge excitation voltage. It provides second-order correction to the transfer function, typically achieving a 20:1 improvement in nonlinearity, even with low cost transducers.

The XTR104 is available in 16-pin plastic DIP and SOL-16 surface-mount packages specified for the -40°C to $+85^{\circ}\text{C}$ temperature range.

APPLICATIONS

- INDUSTRIAL PROCESS CONTROL
- FACTORY AUTOMATION
- SCADA
- WEIGHTING SYSTEMS
- ACCELEROMETERS

BRIDGE NONLINEARITY CORRECTION USING XTR104

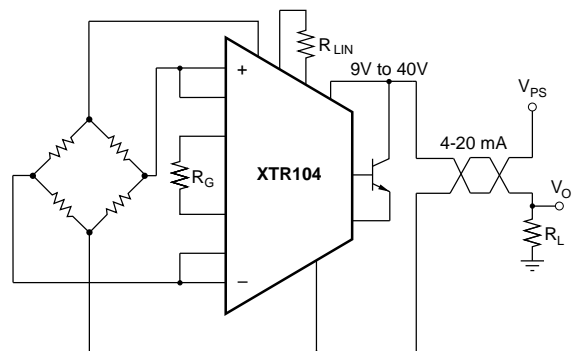
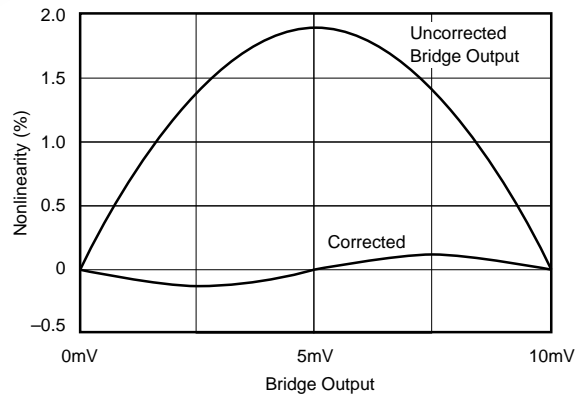

International Airport Industrial Park • Mailing Address: PO Box 11400 • Tucson, AZ 85734 • Street Address: 6730 S. Tucson Blvd. • Tucson, AZ 85706
Tel: (520) 746-1111 • Twx: 910-952-1111 • Cable: BBRCORP • Telex: 066-6491 • FAX: (520) 889-1510 • Immediate Product Info: (800) 548-6132

SPECIFICATIONS

T_A = +25°C, V₊ = 24V, and 2N6121 external transistor, unless otherwise noted.

PARAMETER	CONDITIONS	XTR104BP, BU			XTR104AP, AU			UNITS
		MIN	TYP	MAX	MIN	TYP	MAX	
OUTPUT								
Output Current Equation		$I_O = V_{IN} \cdot (0.016 + 40/R_G) + 4\text{mA}$			V_{IN} in Volts, R_G in Ω			A
Total Adjusted Error ⁽¹⁾	T _{MIN} to T _{MAX} , V _{FS} ≥ 10mV, R _B = 5k Ω			±1			±2	% of FS
Current, Specified Range		4		20	*		*	mA
Over-Scale Limit			34	40		*	*	mA
Under Scale-Limit			3.6	3.8		*	*	mA
Full Scale Output Error	V _{IN} = 1V, R _G = ∞		±15	±50		*	±100	μA
Noise: 0.1Hz to 1kHz	R _G = 40 Ω		8			*		μA _{p-p}
ZERO OUTPUT⁽²⁾	V _{IN} = 0V, R _G = ∞		4			*		mA
Initial Error			±5	±50		*	±100	μA
vs Temperature			±0.2	±0.5		*	±1	μA/°C
vs Supply Voltage, V ₊	V ₊ = 9V to 40V ⁽³⁾		0.5	2		*	*	μA/V
vs Common-Mode Voltage	V _{CM} = 2V to 3V ⁽³⁾		0.1	2		*	*	μA/V
SPAN								
Span Equation (Transconductance)		$S = 0.016 + 40/R_G$						A/V
Untrimmed Error	R _G ≥ 75 Ω		±0.1	±1		*	*	%
vs Temperature ⁽⁴⁾			±20	±50		*	±100	ppm/°C
Nonlinearity: Ideal Input				0.01		*	*	%
Bridge Input ⁽⁵⁾			0.1			*	*	%
INPUT								
Differential Range				1			*	V
Input Voltage Range ⁽³⁾		2		3			*	V
Common-Mode Rejection	V _{IN} = 2V to 3V ⁽³⁾	80	100		*	*		dB
Impedance: Differential			3		*	*		G Ω
Common-Mode			0.5		*	*		G Ω
Offset Voltage			±0.5	±2.5		*	*	mV
vs Temperature			1	2.5		2	5	μV/°C
vs Supply Voltage, V ₊	V ₊ = 9V to 40V ⁽³⁾	110	130	250	*	*	*	dB
Input Bias Current			100		*	*	*	nA
vs Temperature			0.1	2	*	*	*	nA/°C
Input Offset Current			2	20	*	*	*	nA
vs Temperature			0.01	0.25	*	*	*	nA/°C
VOLTAGE REFERENCE⁽⁶⁾								
Voltage			5			*		V
Accuracy			±0.25	±0.5		*	±1	%
vs Temperature			±10	±50		*	±100	ppm/°C
vs Supply Voltage, V ₊	V ₊ = 9V to 40V ⁽³⁾		5			*		ppm/V
vs Load	I _L = 0 to 2mA		50			*		ppm/mA
POWER SUPPLY								
Voltage Range ⁽³⁾ , V ₊		9		40	*		*	V
TEMPERATURE RANGE								
Specification	(T _{MIN} to T _{MAX})	-40		85	*		*	°C
Operating	Derated Performance	-40		125	*		*	°C
θ _{JA}			80			*		°C/W

* Specification same as XTR104BP.

NOTES: (1) Includes corrected second-order nonlinearity of bridge, and over-temperature zero and span effects. Does not include initial offset and span errors which are normally trimmed to zero at 25°C. (2) Describes accuracy of the 4mA low-scale current. Does not include input amplifier effects. Can be trimmed to zero. (3) Voltage measured with respect to I_O pin. (4) Does not include TCR of gain-setting resistor, R_G. (5) When configured to correct for ≤2% second-order bridge sensor nonlinearity. (6) Measured with R_{LIN} = ∞ to disable linearization feature.

PIN CONFIGURATION

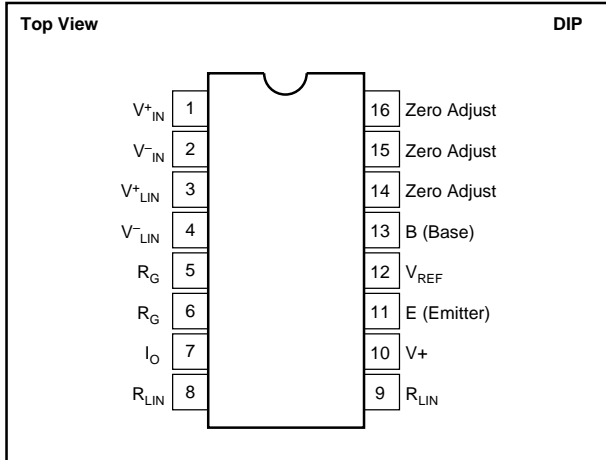

ABSOLUTE MAXIMUM RATINGS

Power Supply, V^+ (referenced to I_O pin)	40V
Input Voltage, V^+_{IN} , V^-_{IN} , V^+_{LIN} , V^-_{LIN} (referenced to I_O pin)	... 0V to V^+
Storage Temperature Range	-55°C to +125°C
Lead Temperature (soldering, 10s)	+300°C
Output Current Limit	Continuous
Junction Temperature	+165°C

PACKAGE INFORMATION

MODEL	PACKAGE	PACKAGE DRAWING NUMBER ⁽¹⁾
XTR104AP	16-Pin Plastic DIP	180
XTR104BP	16-Pin Plastic DIP	180
XTR104AU	SOL-16 Surface Mount	211
XTR104BU	SOL-16 Surface Mount	211

NOTE: (1) For detailed drawing and dimension table, please see end of data sheet, or Appendix D of Burr-Brown IC Data Book.

ORDERING INFORMATION

MODEL	PACKAGE	TEMPERATURE RANGE
XTR104AP	16-pin Plastic DIP	-40°C to +85°C
XTR104BP	16-pin Plastic DIP	-40°C to +85°C
XTR104AU	SOL-16 Surface Mount	-40°C to +85°C
XTR104BU	SOL-16 Surface Mount	-40°C to +85°C



ELECTROSTATIC DISCHARGE SENSITIVITY

Electrostatic discharge can cause damage ranging from performance degradation to complete device failure. Burr-Brown Corporation recommends that all integrated circuits be handled and stored using appropriate ESD protection methods.

ESD damage can range from subtle performance degradation to complete device failure. Precision integrated circuits may be more susceptible to damage because very small parametric changes could cause the device not to meet published specifications.

The information provided herein is believed to be reliable; however, BURR-BROWN assumes no responsibility for inaccuracies or omissions. BURR-BROWN assumes no responsibility for the use of this information, and all use of such information shall be entirely at the user's own risk. Prices and specifications are subject to change without notice. No patent rights or licenses to any of the circuits described herein are implied or granted to any third party. BURR-BROWN does not authorize or warrant any BURR-BROWN product for use in life support devices and/or systems.

DICE INFORMATION

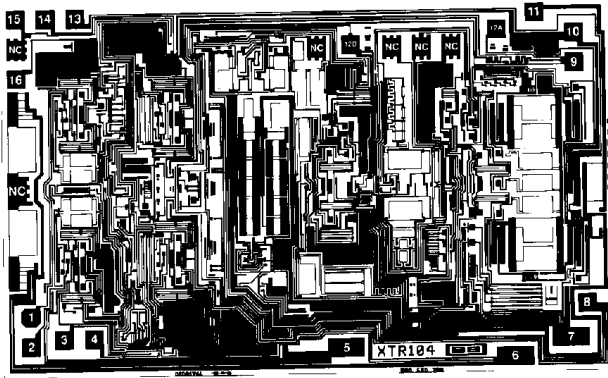

XTR104 DIE TOPOGRAPHY

PAD	FUNCTION	PAD	FUNCTION
1	V_{IN}^+	9	R_{LIN}
2	V_{IN}^-	10	V_+
3	V_{LIN}^+	11	E (Emitter)
4	V_{LIN}^-	12A, 12B	V_{REF}
5	R_G	13	B (Base)
6	R_G	14	Zero Adj.
7	I_O	15	Zero Adj.
8	R_{LIN}	16	Zero Adj.

Pads 12A and 12B must be connected.

NC: No Connection

Substrate Bias: Internally connected to the I_O terminal (#7).

MECHANICAL INFORMATION

	MILS (0.001")	MILLIMETERS
Die Size	168 x 104 \pm 5	4.27 x 2.64 \pm 0.13
Die Thickness	20 \pm 3	0.51 \pm 0.08
Min. Pad Size	4 x 4	0.1 x 0.1
Backing		None



TYPICAL PERFORMANCE CURVES

$T_A = +25^\circ\text{C}$, $V_+ = 24\text{V}$, unless otherwise noted.

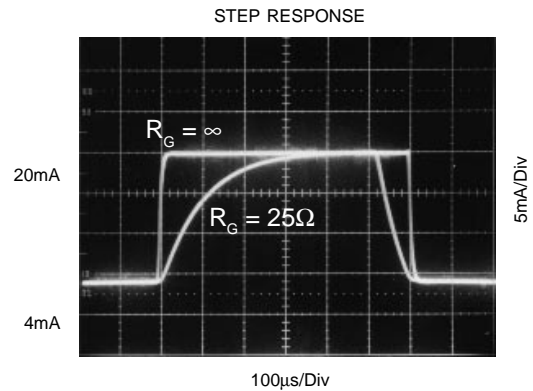
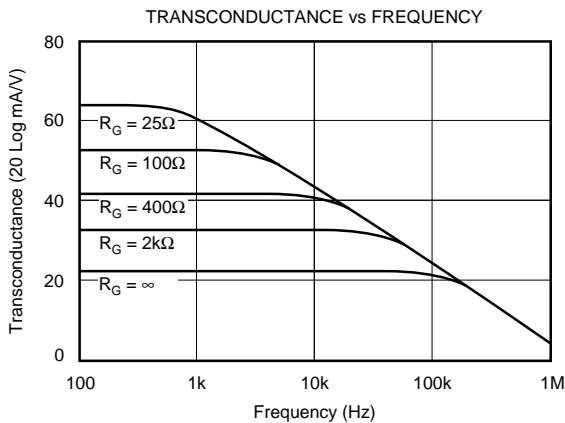

TYPICAL PERFORMANCE CURVES (CONT)

$T_A = +25^\circ\text{C}$, $+V = 24\text{V}$, unless otherwise noted.

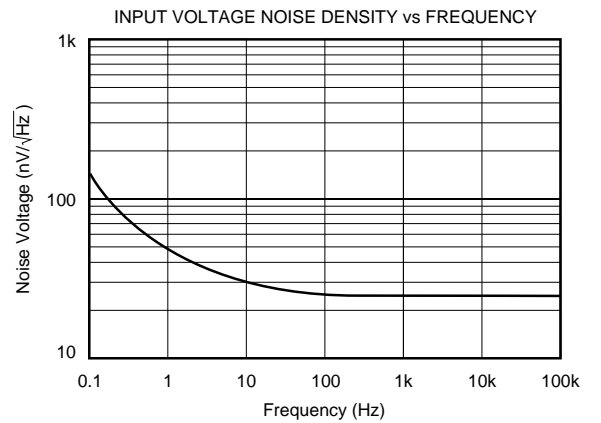
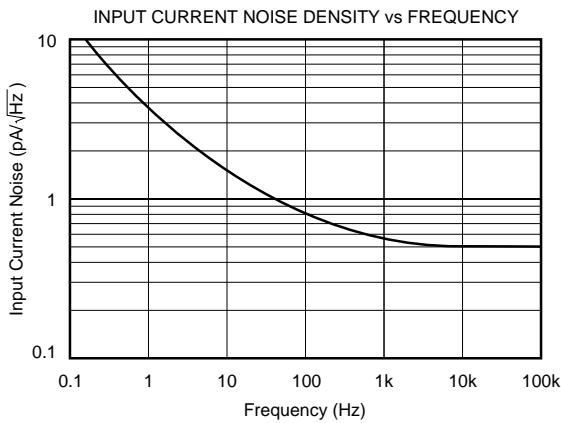
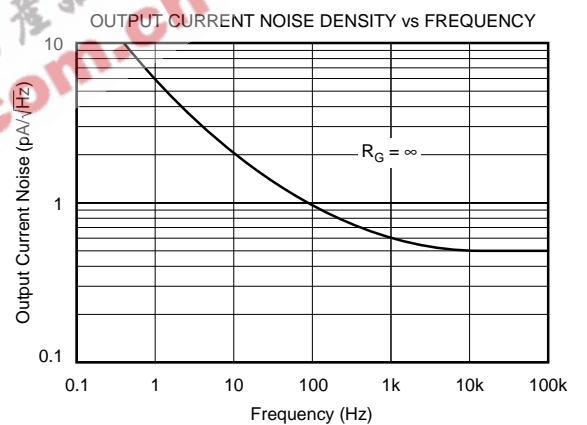
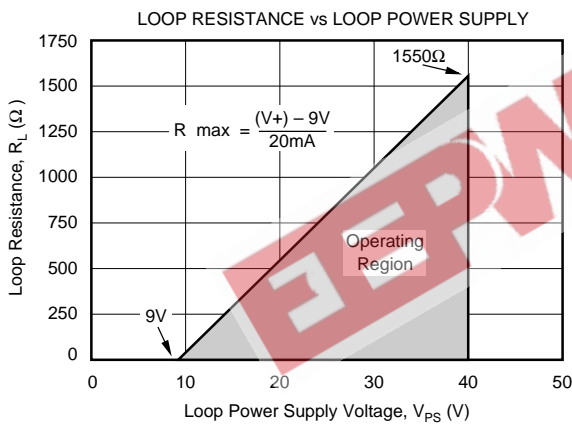
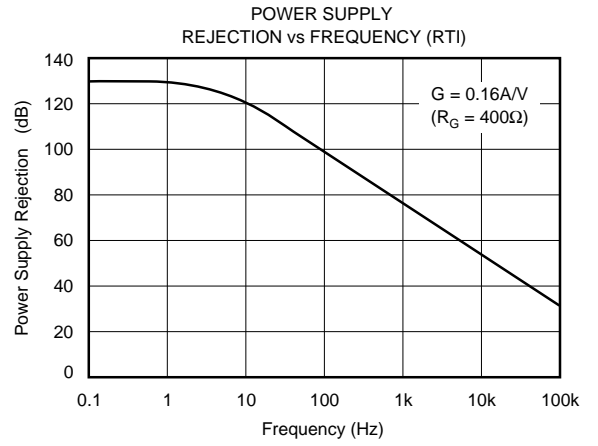
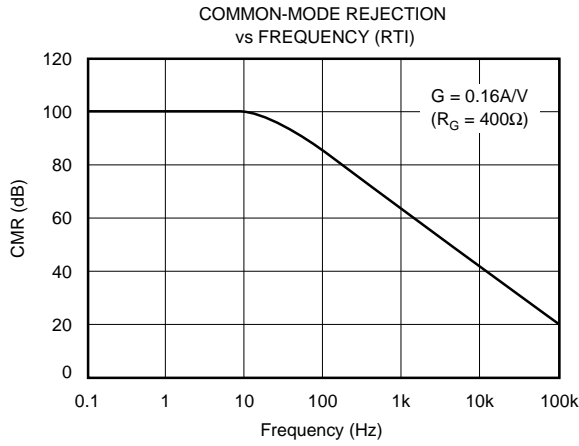

APPLICATION INFORMATION

Figure 1 shows the basic connection diagram for the XTR104. The loop power supply, V_{PS} , provides power for all circuitry. Loop current is measured as a voltage across the series load resistor, R_L .

A high impedance ($\geq 2750\Omega$) strain gage sensor can be excited directly by the 5V reference output terminal, V_R . The output terminals of the bridge are connected to the instrumentation amplifier inputs, V_{IN}^+ and V_{IN}^- . The resistor, R_G , sets the gain of the instrumentation amplifier as required by the full-scale bridge voltage, V_{FS} .

The transfer function is:

$$I_O = V_{IN} \cdot (0.016 + 40/R_G) + 4mA, \quad (1)$$

Where: V_{IN} is the voltage applied to the V_{IN}^+ and V_{IN}^- differential inputs (in Volts.) R_G in Ω .

With no R_G connected ($R_G = \infty$), a 0V to 1V input produces a 4 to 20mA output current. With $R_G = 25\Omega$, a 0V to 10mV input produces a 4 to 20mA output current. Other values for R_G can be calculated as follows:

$$R_G = \frac{2500}{\frac{1}{V_{FS}} - 1} \quad (2)$$

Where: V_{FS} is the full scale voltage applied to the V_{IN}^+ and V_{IN}^- differential inputs (in Volts).

R_G in Ω .

Under-scale input voltage (negative) will cause the output current to decrease below 4mA. Increasingly negative input will cause the output current to limit at approximately 3.6mA.

Increasingly positive input voltage (above V_{FS}) will produce increasing output current according to the transfer function, up to the output current limit of approximately 34mA.

EXTERNAL TRANSISTOR

Transistor Q_1 conducts the majority of the signal-dependent 4 to 20mA loop current. Using an external transistor isolates the power dissipation from the precision input and reference circuitry of the XTR104, maintaining excellent accuracy.

Since the external transistor is inside a feedback loop its characteristics are not critical. Many common NPN types can be used. Requirements for operation at the full loop supply voltage are: $V_{CEO} = 45V$ min, $\beta = 40$ min and $P_D = 800mW$. Power dissipation requirements may be lower if the maximum loop power supply voltage is less than 40V. Some possible choices for Q_1 are listed in Figure 1.

LOOP POWER SUPPLY

The voltage applied to the XTR104, V_+ , is measured with respect to the I_O connection, pin 7. V_+ can range from 9V to 40V. The loop supply voltage, V_{PS} , will differ from the voltage applied to the XTR104 according to the voltage drop on the current sensing resistor, R_L (plus any other voltage drop in the line).

If a low loop supply voltage is used, R_L must be made a relatively low value to assure that V_+ remains 9V or greater for the maximum loop current of 20mA. It may, in fact, be prudent to design for V_+ equal or greater than 9V with loop currents up to 34mA to allow for out-of-range input conditions. The typical performance curve "Loop Resistance vs Loop Power Supply" shows the allowable sense resistor values for full-scale 20mA.

The low operating voltage (9V) of the XTR104 allows operation directly from personal computer power supplies (12V \pm 5%). When used with the RCV420 Current Loop Receiver (see Figure 9), load resistor voltage drop is only 1.5V at 20mA.

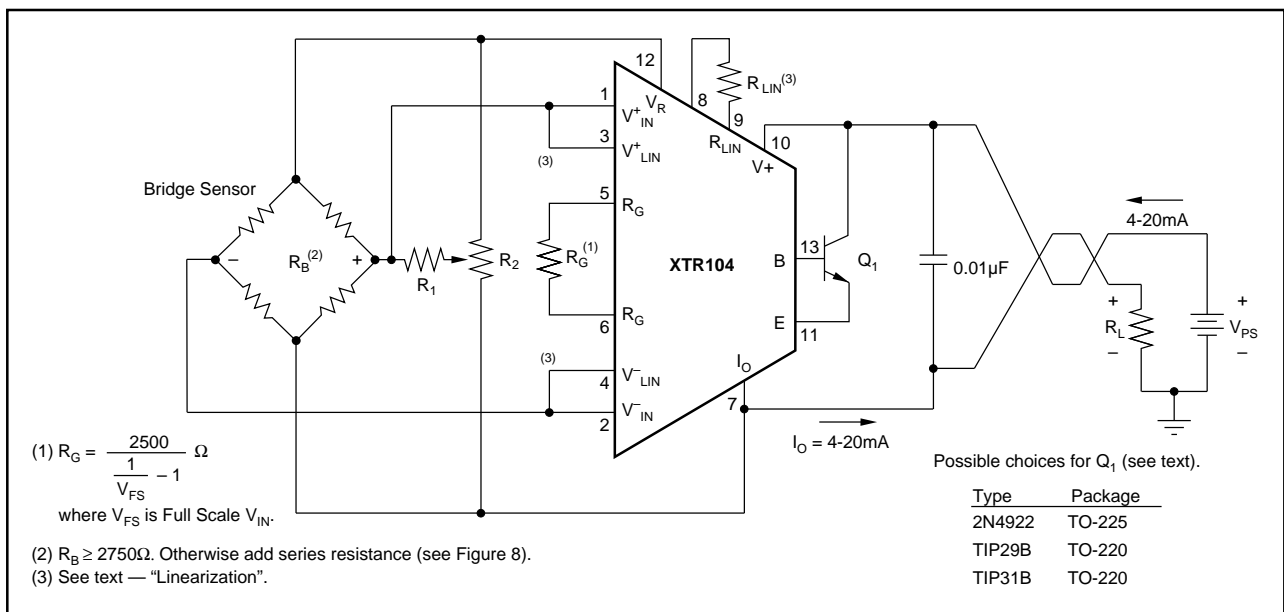

FIGURE 1. Bridge Sensor Application, Connected for Positive Nonlinearity.

BRIDGE BALANCE

Figure 1 shows a bridge trim circuit (R_1 , R_2). This adjustment can be used to compensate for the initial accuracy of the bridge and/or to trim the offset voltage of the XTR104. The values of R_1 and R_2 depend on the impedance of the bridge, and the trim range required. This trim circuit places an additional load on the V_R output. The effective load of the trim circuit is nearly equal to R_2 . Total load on the V_R output terminal must not exceed 2mA. An approximate value for R_1 can be calculated:

$$R_1 \approx \frac{5V \cdot R_B}{4 \cdot V_{TRIM}} \quad (3)$$

Where: R_B is the resistance of the bridge.

V_{TRIM} is the desired \pm voltage trim range (in V).

Make R_2 equal or lower in value to R_1 .

Figure 2 shows another way to adjust zero errors using the output current adjustment pins of the XTR104. This provides $\pm 500\mu A$ (typical) adjustment around the initial low-scale output current. This is an output current adjustment that is independent of the input stage gain set with R_G . If the input stage is set for high gain the output current adjustment may not provide sufficient range.

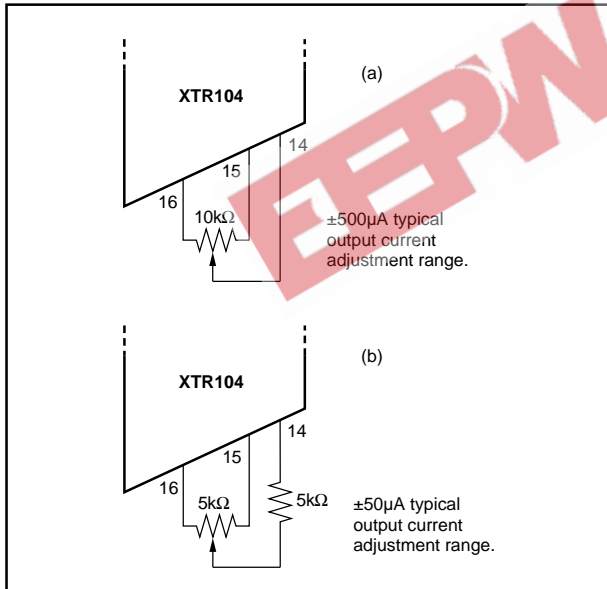

FIGURE 2. Low-scale Output Current Adjustment.

LINEARIZATION

Differential voltage applied to the linearization inputs, V_{LIN}^+ and V_{LIN}^- , causes the reference (excitation) voltage, V_R , to vary according to the following equation:

$$V_R = 5V + V_{LIN} \frac{K_{LIN}}{R_{LIN}} \quad (4)$$

Where: V_{LIN} is the voltage applied to the V_{LIN}^+ and V_{LIN}^- differential inputs (in V).

R_{LIN} in Ω .

$K_{LIN} \approx 24000$ (approximately $\pm 20\%$ depending on variations in the fabrication of the XTR104).

With V_{LIN}^+ and V_{LIN}^- connected to the bridge output, the bridge excitation voltage can be made to vary as much as $\pm 0.5V$ in response to the bridge output voltage. Be sure that the total load on the V_R output is less than 2mA at the maximum excitation voltage, $V_R = 5.5V$.

Signal-dependent variation of the bridge excitation voltage provides a second-order term to the complete transfer function (including the bridge). This can be tailored to correct for bridge sensor nonlinearity. Either polarity of nonlinearity (bowing up or down) can be compensated by proper connection of the V_{LIN} inputs. Connecting V_{LIN}^+ to V_{IN}^+ and V_{LIN}^- to V_{IN}^- (Figure 1) causes V_R to increase with bridge output which compensates for a positive bow in the bridge response. Reversing the connections (Figure 3) causes V_R to decrease with increasing bridge output, to compensate for negative-bowing nonlinearity.

To determine the required value for R_{LIN} you must know the nonlinearity of the bridge sensor with constant excitation voltage. The linearization circuitry can only compensate for the parabolic portion of a sensor's nonlinearity. Parabolic nonlinearity has a maximum deviation from linear occurring at mid-scale (see Figure 4). Sensors with nonlinearity curves similar to that shown in Figure 4, but not peaking exactly at mid-scale can be substantially improved. A nonlinearity that is perfectly "S-shaped" (equal positive and negative nonlinearity) cannot be corrected with the XTR104. It may, however, be possible to improve the worst-case nonlinearity of a sensor by equalizing the positive and negative nonlinearity.

The nonlinearity, B (in % of full scale), is positive or negative depending on the direction of the bow. A maximum of $\pm 2.5\%$ nonlinearity can be corrected. An approximate value for R_{LIN} can be calculated by:

$$R_{LIN} = \frac{K_{LIN} \cdot V_{FS}}{0.2 \cdot B} \quad (5)$$

Where: $K_{LIN} \approx 24000$.

V_{FS} is the full-scale bridge output (in Volts) with constant 5V excitation.

B is the parabolic nonlinearity in $\pm\%$ of full scale.

R_{LIN} in Ω .

Methods for refining this calculation involve determining the actual value of K_{LIN} for a particular device (explained later).

B is a signed number (negative for a downward-bowing nonlinearity). This can produce a negative value for R_{LIN} . In this case, use the resistor value indicated (ignore the sign), but connect V_{LIN}^+ to V_{IN}^- and V_{LIN}^- to V_{IN}^+ as shown in Figure 3.

This approximate calculation of R_{LIN} generally provides about a 5:1 improvement in bridge nonlinearity.

Example: The bridge sensor depicted by the negative-bowing curve in Figure 4. Its full scale output is 10mV with constant 5V excitation. Its maximum nonlinearity, B, is -1.9% referred to full scale (occurring at mid-scale). Using equation 5:

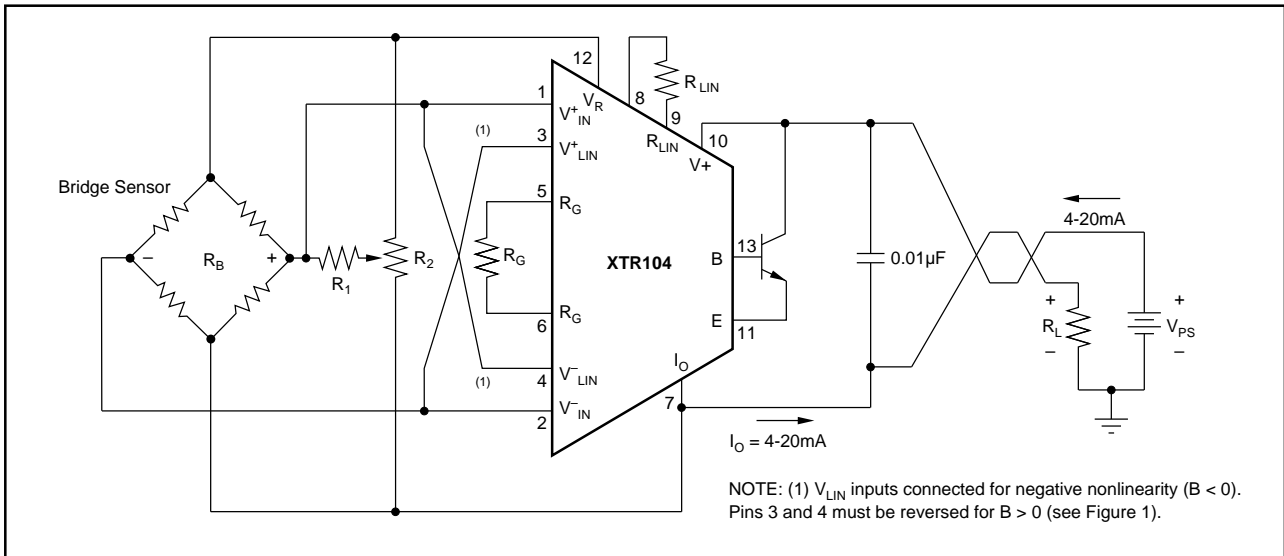

FIGURE 3. Bridge Sensor, V_{LIN} Connected for Negative Nonlinearity.

$$R_{LIN} \approx \frac{24000 \cdot 0.01}{0.2 \cdot (-1.9)} = -632 \Omega$$

Use $R_{LIN} = 632\Omega$. Because the calculation yields a negative result, connect V_{LIN}^+ to V_{IN}^- and V_{LIN}^- to V_{IN}^+ .

Gain is affected by the varying the excitation voltage. For each 1% of corrected nonlinearity, the gain must be altered by 4%. As a result, equation 2 will not provide an accurate R_G when nonlinearity correction is used. The following equation calculates the required value for R_G to compensate for this effect.

$$R_G = \frac{2500}{(1 + 0.04 \cdot B) \frac{V_{FS}}{V_{IN}} - 1} \quad (6)$$

B must again be a signed number in this calculation—positive for positive bowing nonlinearity, and negative for a negative-bowing nonlinearity.

$$R_G = 23.32\Omega \text{ for the example above.}$$

A more accurate value for R_{LIN} can be determined by first measuring the actual gain constant of the linearization inputs, K_{LIN} (see equation 4). Measure the change in the reference voltage, ΔV_R , in response to a measured voltage change at the linearization inputs, ΔV_{LIN} . Make this measurement with a known, temporary test value for R_{LIN} . These measurements can be made during operation of the circuit by providing stimulus to the bridge sensor, or by temporarily unbalancing the bridge with a fixed resistor in parallel with one of the bridge resistors. Calculate the actual K_{LIN} :

$$K_{LIN} = \frac{\Delta V_R \cdot R_{TEST}}{\Delta V_{LIN}} \quad (7)$$

Where: ΔV_{LIN} is the change in voltage at V_{LIN} .
 ΔV_R is the measured change in reference voltage, V_R .
 R_{TEST} is a temporary fixed value of R_{LIN} (in Ω).

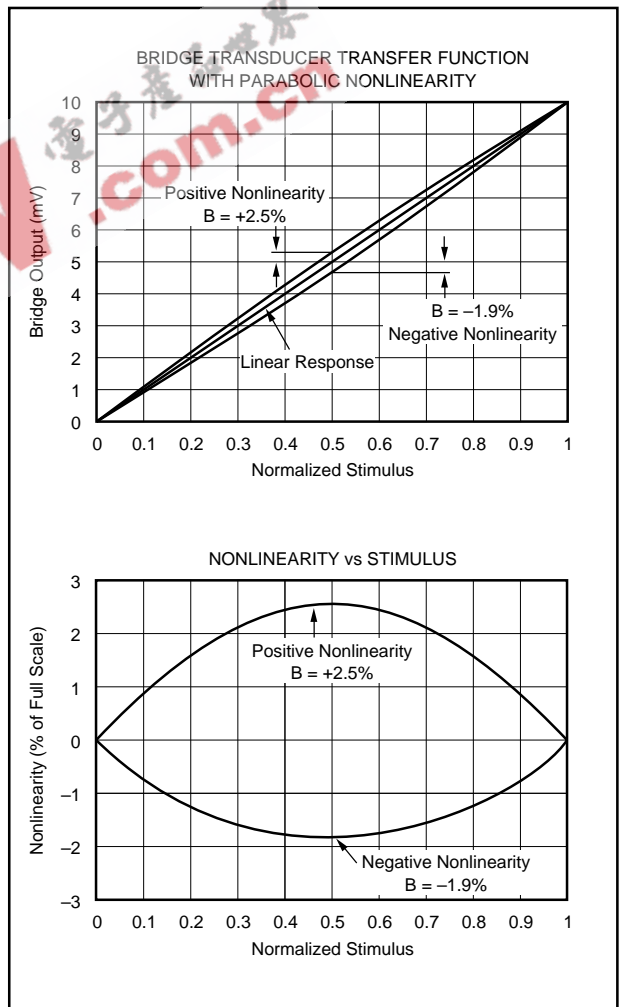

FIGURE 4. Parabolic Nonlinearity.

Then, R_{LIN} can be calculated using equation 5 using the accurate value of K_{LIN} from equation 7. K_{LIN} can be a different value for each XTR104.

It is also possible to make a real-time adjustment of R_{LIN} with a variable resistor (active circuit trimming). This is done by measuring the change in V_R in response to a zero-to- V_{FS} change in voltage applied to the V_{LIN} inputs. To correct for each 1% of nonlinearity, the excitation voltage, V_R , must make a 4% change at full-scale input. So the change in reference voltage, ΔV_R , for a full-scale change in V_{LIN} can be calculated by:

$$\Delta V_R = 0.2 \cdot B \quad (8)$$

Example: A bridge sensor has a -1.9% nonlinearity. Apply the full-scale bridge output, V_{FS} (10mV), to the V_{LIN} inputs and adjust R_{LIN} for:

$$V_R' = 5V + 0.2 \cdot B = 4.62V$$

Note that with all the calculation and adjustment methods described above, the full-scale bridge output is no longer equal to V_{FS} because the excitation voltage at full scale is no longer 5V. All the calculations and adjustment procedures described above assume V_{FS} to be the full-scale bridge output with constant 5V excitation. It is not necessary to iterate the calculations or adjustment procedures using the new full-scale bridge output as a starting point. However, a new value for R_G must be calculated using equation 6.

A refined value for R_{LIN} , arrived at either by active circuit trimming, or by measuring linearization gain (equation 7) will improve linearity. Reduction of the original parabolic nonlinearity of the sensor can approach 40:1. Actual results will depend on higher-order nonlinearity of the sensor.

If no linearity correction is desired, make no connections to the R_{LIN} pins ($R_{LIN} = \infty$). This will cause the V_R output to remain a constant +5V. The V_{LIN}^+ and V_{LIN}^- inputs should remain connected to the bridge output to keep these inputs biased in their active region.

OTHER SENSOR TYPES

The XTR104 can be used with a wide variety of inputs. Its high input impedance instrumentation amplifier is versatile and can be configured for differential input voltages from millivolts to a maximum of 1V full scale. The linear common-mode range of the inputs is from 2V to 4V, referenced to the I_O terminal, pin 7.

You can use the linearization feature of the XTR104 with any sensor whose output is ratiometric with an excitation voltage. For example, Figure 5 shows the XTR104 used with a potentiometer position sensor.

REVERSE-VOLTAGE PROTECTION

Figure 6 shows two ways to protect against reversed output connection lines. Trade-offs in an application will determine which technique is better. D_1 offers series protection, but causes a 0.7V loss in loop supply voltage. This may be undesirable if V_+ can approach the 9V limit. Using D_2 (without D_1) has no voltage loss, but high current will flow in the loop supply if the leads are reversed. This could damage the power supply or the sense resistor, R_L . A diode with a higher current rating is needed for D_2 to withstand the highest current that could occur with reversed lines.

SURGE PROTECTION

Long lines may be subject to voltage surges which can damage semiconductor components. To avoid damage, the maximum applied voltage rating for the XTR104 is 40V. A zener diode can be used for D_2 (Figure 7) to clamp the voltage applied to the XTR104 to a safe level. The loop power supply voltage must be lower than the voltage rating of the zener diode.

There are special zener diode types (Figure 7) specifically designed to provide a very low impedance clamp and withstand large energy surges. These devices normally have a diode characteristic in the forward direction which also

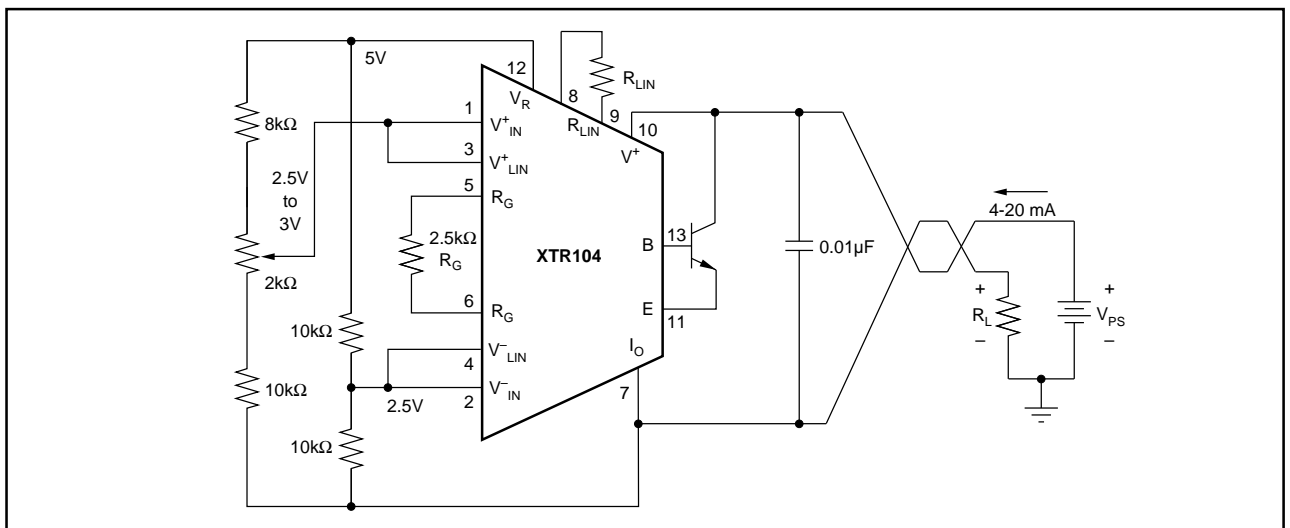

FIGURE 5. Potentiometer Sensor Application.

protects against reversed loop connections. As noted earlier, reversed loop connections would produce a large loop current, possibly damaging R_L .

RADIO FREQUENCY INTERFERENCE

The long wire lengths of current loops invite radio frequency interference. RF can be rectified by the sensitive input circuitry of the XTR104 causing errors. This generally appears as an unstable output current that varies with the position of loop supply or input wiring.

If the bridge sensor is remotely located from the XTR104, the interference may enter at the input terminals. For integrated transmitter assemblies with short connections to the sensor, the interference more likely comes from the current loop connections.

Bypass capacitors on the input often reduce or eliminate this interference. Connect these bypass capacitors to the I_O terminal (see Figure 7). Although the DC voltage at the I_O terminal is not equal to 0V (at the loop supply, V_{PS}) this circuit point can be considered the transmitter's "ground".

LOW-IMPEDANCE BRIDGES

Low impedance bridges can be used with the XTR104 by adding series resistance to limit excitation current to $\leq 2\text{mA}$. Equal resistance should be added to the upper and lower sides of the of the bridge (Figure 8) to keep the bridge output voltage centered at approximately 2.5V. Bridge output is reduced, so a preamplifier, as shown, may be needed to reduce offset and drift.

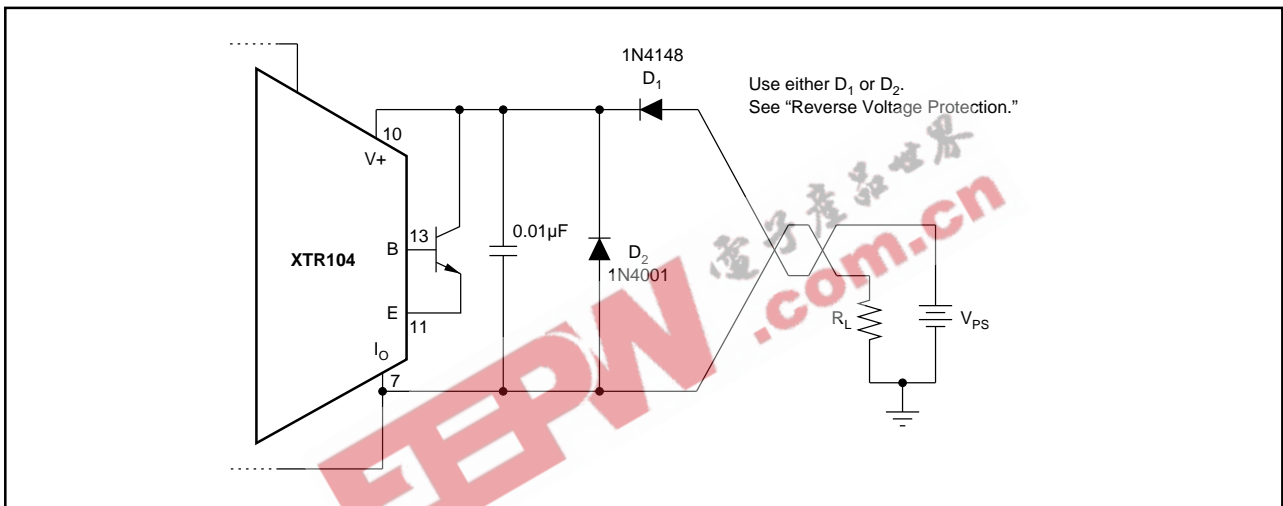

FIGURE 6. Reverse Voltage Protection.

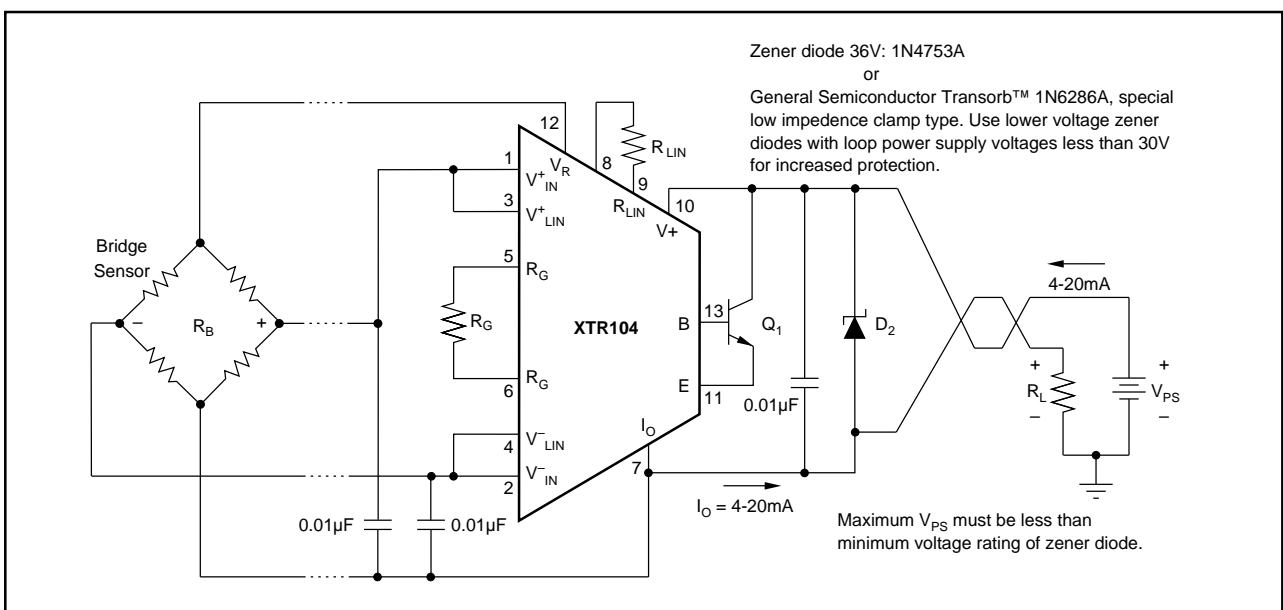

FIGURE 7. Over-Voltage Surge Protection.

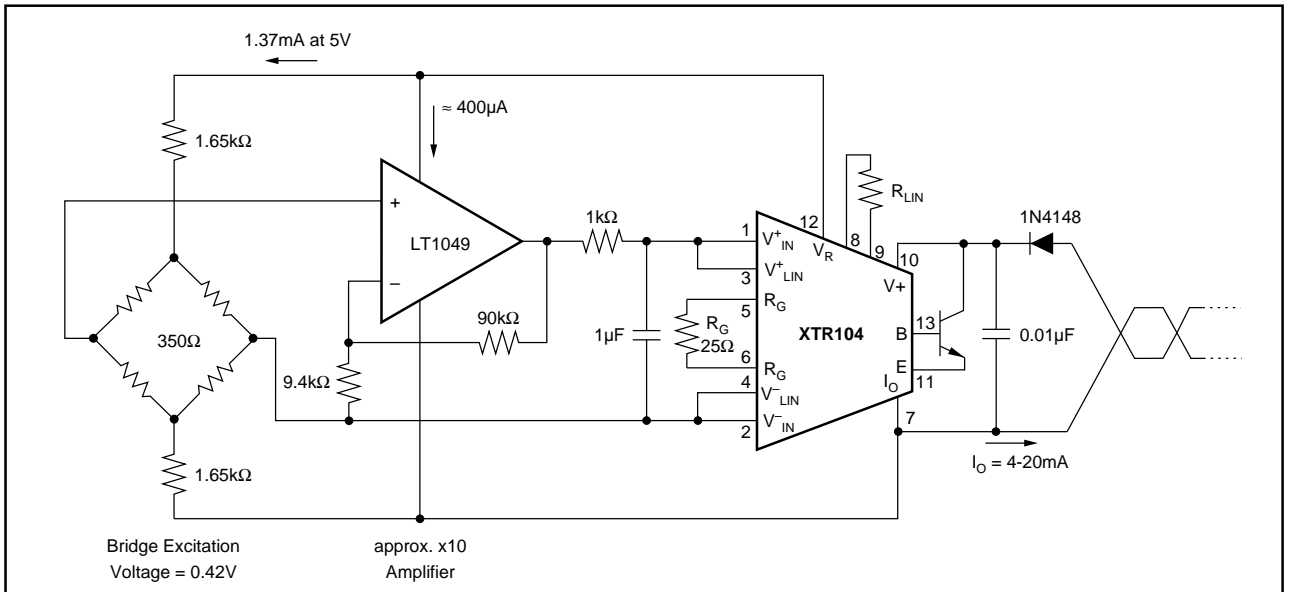

FIGURE 8. 350Ω Bridge With X10 Preamplifier.

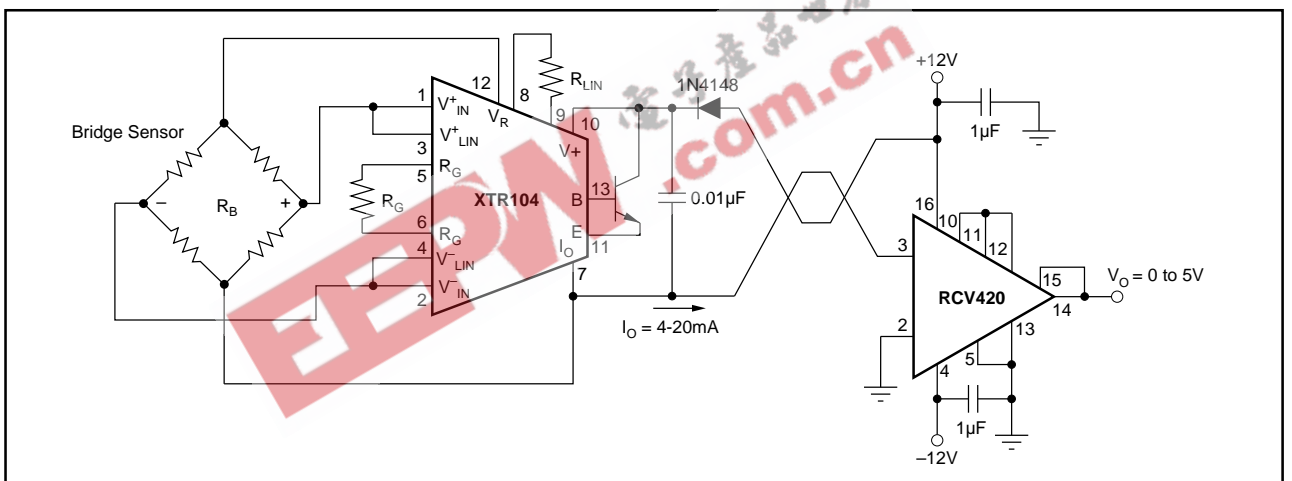

FIGURE 9. ±12V-Powered Transmitter/Receiver Loop.

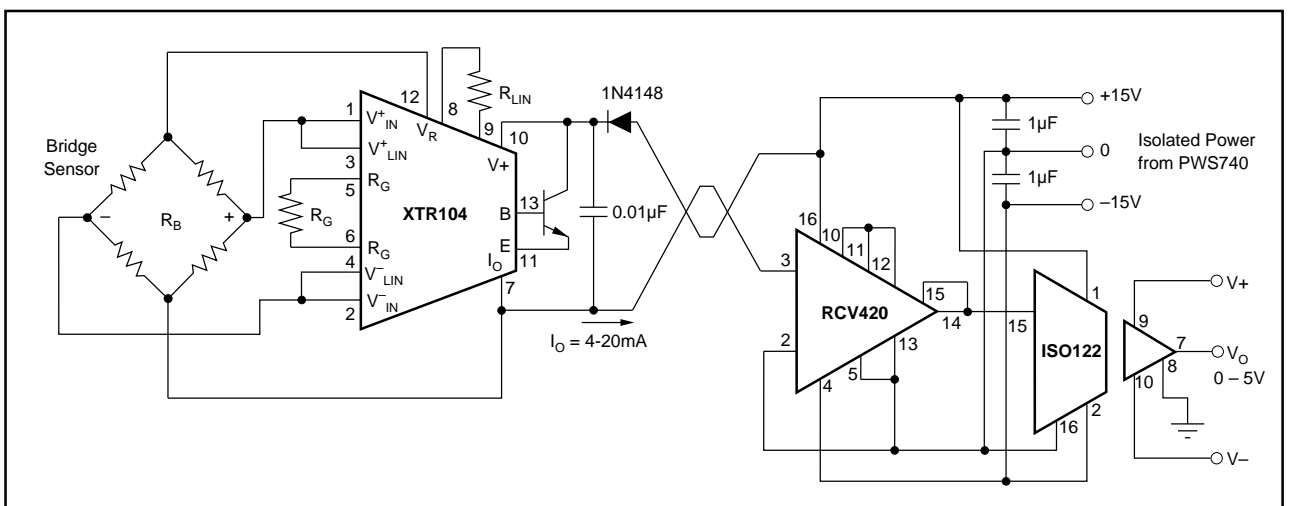

FIGURE 10. Isolated Transmitter/Receiver Loop.