

User's Guide



Dual Input, 3-Display Thermometer/Datalogger

Model 421509

- Accepts J, K, T, E, R, S, & N thermocouples
- Internal Memory stores up to 16 data sets, with 1024 maximum data capacity
- Backlit Electro-luminescent LCD Display
- T1 / T2 / T1 – T2 displays
- MIN / MAX / AVG Record/Recall
- Selectable temperature units (C/F)
- Data Hold, Relative Mode, Elapsed Timer
- Bi-directional RS-232 PC Interface



Introduction

Congratulations on your purchase of Extech's Dual Input, 3-Display, Hand-Held Digital Thermometer/Datalogger. This portable digital thermometer is designed to use external K / J / T / E / R / S / N type thermocouples (K-type supplied). Temperature indication follows Reference Temperature/Voltage Tables (N.I.S.T. Monograph 175 Revised to ITS-90). It features an adjustable T/C offset and an RS-232 interface for uploading data to a PC using optional software and cable. This professional meter, with proper care, will provide years of safe reliable service.

Specifications

General Specifications

Display	4-1/2 digit (19,999), 3-Display, LCD with EL Backlighting
Input Protection	24VDC or 24VAC rms maximum input on any combination of inputs. Max voltage between T1 and T2 inputs is 1V
Reading rate	2.5 times per second
Input connectors	Accepts standard sub-miniature thermocouple connectors
Alarm Output	6-pin mini DIN, max. 5mA@5 to 30VDC (external source)
Operating conditions	32 to 122°F (0 to 50°C); less than 80% RH
Storage conditions	-4 to 140°F (-20 to 60°C); less than 70% RH
Dimensions / Weight	7.5 x 3.6 x 2.1" (192 x 91 x 52.5mm); 11.7oz. (365g)
Power Supply	9V battery or optional AC Adaptor
Auto Power off	User programmable from 5 to 19999 minutes
Battery life	100 hours typical

Range Specifications

Thermocouple	Range	Resolution
K type	-328 to 2501°F (-200 to 1372°C)	0.1°F (0.1°C), 1°F > 2000°
J type	-346 to 2192°F (-210 to 1200°C)	0.1°F (0.1°C), 1°F > 2000°
T type	-328 to 752°F (-200 to 400°C)	0.1°F (0.1°C)
E type	-346 to 1832°F (-210 to 1000°C)	0.1°F (0.1°C)
R type	32 to 3212°F (0 to 1767°C)	1°F (1°C)
S type	32 to 3212°F (0 to 1767°C)	1°F (1°C)
N type	-58 to 2372°F (-50 to 1300°C)	0.1°F (0.1°C)

Accuracy Specifications

Thermocouple	Accuracy
K, J, T, E types	±(0.05% rdg + 0.6°F) -58°F to 2501°F ±(0.05% rdg + 1.4°F) -58°F to -346°F ±(0.05% rdg + 0.3°C) -50°C to 1370°C ±(0.05% rdg + 0.7°C) -50°F to -210°C
N type	±(0.05% rdg + 1.6°F) -58°F to 32°F ±(0.05% rdg + 0.8°F) 32°F to 2372°F ±(0.05% rdg + 0.8°C) -50°C to 0°C ±(0.05% rdg + 0.4°C) 0°F to 1300°C
R, S types	±(0.05% rdg + 4.0°F) 32°F to 3212°F ±(0.05% rdg + 2.0°C) 0°C to 1767°C
Temperature Coefficient	0.1 multiplied by the accuracy per °C from 0°C to 18°C and 28°C to 50°C (32°F to 64°F and 82°F to 122°F)
Supplied Thermocouples	4', type K (with teflon insulation) Max insulation temp: 500°F (260°C) Accuracy: ± 4°F (±2.2°C) or ± 0.75% of rdg (whichever is greater) from 32 to 1472°F (0 to 800°C)

Safety Information

Please read the safety and operational instructions before using this device.

WARNING

To avoid electrical shock, do not use this instrument when working near voltages over 24V AC/DC.

WARNING

To avoid damage or burns, do not make temperature measurement in microwave ovens.

CAUTION

Repeated flexing can break the thermocouple leads. To prolong lead life, avoid sharp bends in the leads, especially near the connector.



This symbol on the instrument indicates that the operator must refer to an explanation in this manual.

Meter Description

1. Optical RS-232 Interface
2. Thermocouple inputs
3. Mini DIN I/O port
4. Triple LCD Display
5. Keypad Overlay
6. Keypad
7. Protective rubber holster
8. Battery compartment on rear
9. 12VDC Adaptor input

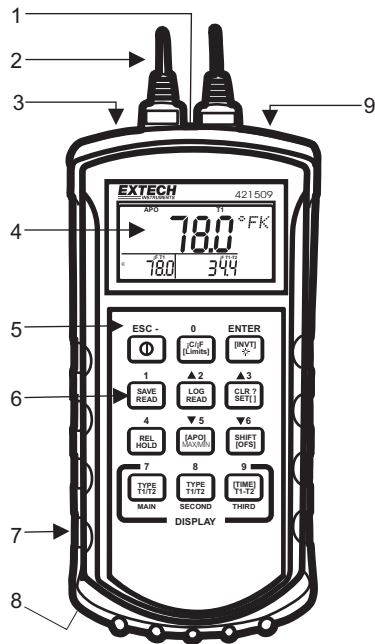

Operation

There are three operation modes—**Normal**, **Shift**, and **Setup mode**

Normal Mode

This is the default mode. The operating functions for normal mode are printed on the face of each button in white. The following functions can only be used in Normal Mode.

Power Button

The Power key turns the thermometer ON or OFF. When entering data in Setup Mode, the power off function is disabled.

[Limits] Button

The Limits function will alert the user when a measurement exceeds a specified limit. To set the limit values, refer to the limits function in the Setup Mode. Press the [Limits] button to activate the Limits function ("LIMIT" will be displayed on the LCD). When the measured temperature on the main display is higher than the High Limit (or lower than the Low Limit), the alarm beeper emits a tone and "Hi" or "Lo" is displayed. Note: The tones for High and Low Alarms are different; the High Alarm tone is pulsed while the Low Alarm tone is continuous. Note: When reading over 2000°F using a K or J thermocouple, the reading should be multiplied by 10. (example: 2100°F x 10 = 21000). To exit the Limits function, press the [Limits] button. In this mode, the automatic power-off feature is disabled along with the following keys: REL, HOLD, & MIN MAX.

Backlight Button

Press the backlight button to toggle the backlighting on and off. The backlight will switch-off automatically after 60 seconds to conserve battery life.

SAVE/READ Button

The Read data function is used for reading saved data. It works in conjunction with the Save function in the Shift Mode.

1. Press the SAVE/READ button to activate the read data function. The word READ will be displayed on the LCD.
2. Press the "SECOND" button until the # sign is displayed in the bottom left display. The location of the read pointer within the saved data table will be displayed.
3. Press the "▲3" or "▼6" button to display the next data location. Press the "▲2" or "▼5" button to increment the data location by ten.
4. Press the overlay "ESC" button to deactivate the read data function.

LOG/READ Button

The read log function is used for reading logged data. It works in conjunction with the Log function in Shift Mode.

1. Press the LOG/READ button to activate the read log function. The word READ will be displayed in the lower right display.
2. Press the overlay "SECOND" button to rotate through the following display menus: T1, T2, GRP, and #. T1 and T2 displays the T1 or T2 saved value. GRP displays the current group number and # displays the current location of the read pointer within a selected group.
3. The arrow buttons on the overlay are used for scrolling through the saved data. Press the "▲3" or "▼6" buttons to display the next data location or group. Press the "▲2" or "▼5" buttons to increment to the next data or group location by ten. To navigate around the logged data and groups, press the overlay "SECOND" button until "GRP" appears in the display. Select the group using the arrow buttons, then press the "SECOND" button again until the "#" sign is displayed. The location of the read pointer will be displayed. Use the arrow keys to scroll through the data.
4. Press the overlay "ESC" button to deactivate the read log data function.

HOLD Mode (Main Display only)

Press the HOLD button to enter the Data Hold mode, the "HOLD" annunciator will display. When HOLD is selected, the thermometer freezes the reading on the main display only. Press the HOLD button again to return to the normal measurement mode.

MIN/MAX with Time Record Mode (Main Display only)

Note: Auto Power OFF and several keys (Power, C/F, REL, SET, HI/LO, TYPE, and T1, T2, T1-T2) are defeated in this mode

Press MIN MAX to enter the MIN/MAX recording mode; the meter will begin keeping track of the highest (MAX), lowest (MIN), MAX-MIN, and Average (AVG) readings. There are four displays (listed below) for this mode. Use the MIN MAX key to scroll through all four.

1. When the "REC" icon is on the display (top), the meter is displaying measurements normally while it is recording.
2. With the "REC MAX" icon on the display, the meter continues taking measurements but the main display shows only the highest (MAX) reading recorded. The Elapsed Time (in hours, minutes, and seconds) is shown in the lower right LCD field. The Timer shows when the MAX reading was taken.
3. With the "REC MIN" icon on the display, the main display shows only the lowest reading recorded. The Time of the MIN reading is shown in the lower right LCD field.
4. With the "REC MAX-MIN" icon on the display, the main display shows the difference between Max and Min.
5. With the "REC AVG" icon on the display, the main display shows only the average of all the readings recorded. Note that the averaging limit is 22 hours. After 22 hours, the last average reading display is held on the LCD.

The meter emits a tone when a new minimum or maximum value is recorded. Use the HOLD button to pause recording (all values are then held). Press HOLD again to resume recording. To exit the MIN MAX mode press and hold the MIN MAX button for more than 2 seconds until the "REC" icon switches off.

T1/T2 Button (Main Display)

Press this button to select which thermocouple input configuration is represented on the main display; 'T1' will display for thermocouple input 1 or 'T2' for thermocouple 2. When the meter is turned on, it is set to the display that was in use when the meter was last powered off.

T1/T2 (Second Display)

Press this button to select which input is shown on the secondary display (lower left display); T1 for thermocouple 1 or T2 for thermocouple 2. When the meter is turned on, it is set to the display that was in use when the meter was last powered off.

T1-T2/Time (Third Display)

Press this button to select system time, date, or the differential between the two thermocouples (T1-T2) for the third display (lower right display). When the meter is turned on, it is set to the display that was in use when the meter was last powered off.

Shift Mode

The operating functions for the shift mode are printed in yellow on the buttons. When in normal mode, push the SHIFT button to switch to shift mode. The word "Shift" will be displayed in the lower right corner of the LCD. To switch back to normal mode, press the SHIFT button again.

°C/°F Key

Readings can be displayed in degrees Celsius (°C) or degrees Fahrenheit (°F). Note that the meter remembers the unit of measure when it is turned off. Press the °C/°F key to change the temperature units.

SAVE Button

The save function stores T1 and T2 measurements in up to 128 locations in non-volatile memory. Press the SAVE button to store the current reading, the word "SAVE" is momentarily displayed on the bottom right LCD to indicate that the data has been saved. Data can be read using the read function in normal mode.

LOG Button

The data log function continuously records measurement data using the stored sampling interval. The time interval is set using the interval time setup function [INTV] in the setup mode.

Press the LOG button to activate the log function. "LOG" will be displayed and "MEM" will continuously flash on the LCD. There are 16 groups that are used for storing the log data and each group has 64 data locations. If the current session exceeds 64 locations, the log function will automatically use the next group to continue storing the data. A maximum of 1024 locations can be saved in one log session.

Press the LOG button again to exit the data log function.

CLR ? Button

The CLR function clears all the saved and logged data in memory. When the CLR button is pressed, "MEM" is displayed and "CLR" flashes on the upper right of the LCD.

Press the overlay "ENTER" button to clear all saved and logged data, or the "ESC" button to exit the function.

REL Button

Press the REL key to enter the Relative mode. The meter will store the displayed reading (main display) as a reference value and display 'REL'. All subsequent readings will now display the measured value less the stored reference value.

Press the REL key again to exit the relative mode.

[APO] Button

Press the APO button to enable/disable auto power off. "APO" is displayed on the upper left of the LCD. When enabled, it will automatically turn the thermometer off if the key switch is inactive for the preset auto power off time (default time for APO is 5 minutes). The time can be programmed in Setup Mode. Press the Power button to resume operation.

Type Button (Main display)

Press the TYPE button to select the thermocouple type (K, J, T, E, R, S, or N) in the main display. If the inputs of the main and second display are the same, then pressing this button will change the thermocouple type for both displays. The selected type becomes the default selection.

Type Button (Second display)

Press the TYPE button to select the thermocouple type (K, J, T, E, R, S, or N) in the second display. If the inputs of the main and second display are the same, then pressing this button will change the thermocouple type for both displays. The selected type becomes the default selection.

Setup Mode

The operating functions for the setup mode are printed between the bracket “[]” signs on each button. Press the SET [] button in normal mode to switch to the setup mode. The indicator “SET” will be shown on the left side of the display. Press SET [] again to return to normal mode.

Hi/Lo Limit Setup

In Setup Mode, press the [Limits] button to enter the Hi/Lo setup function. The “LIMIT”, “HI”, and main display will blink on the LCD and the previous settings will be displayed. Press the number buttons (printed in white) on the overlay to set Hi and Lo limit values. The button “-“ (same as the ESC overlay) can be used to set a negative value. Setting is from left to right digit. Press the ENTER button to confirm each setting.

Mini DIN Hi/Lo Alarm Output

The alarm output jack (refer to Figure 1), located on the top of the meter, can be used to power external warning or switching devices when programmed Hi/Lo alarm limits are reached. To enable this function, an external power source (5 to 30VDC, 5mA max) must be used to supply power to the connected device. Connect the power source (5-30VDC) between pin 5 (+) and pin 6 (-) of the connector (refer to Figure 2). For the Hi limit output, connect a device between pin 1 (+) and pin 2 (-) (refer to Figure 3). For the Lo limit output, connect a device between pin 3 (+) and pin 4 (-) (refer to Figure 4).

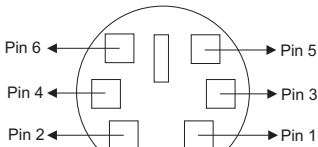

Figure 1

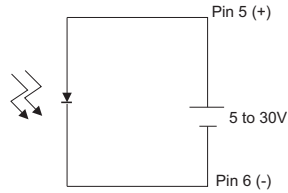

Figure 2

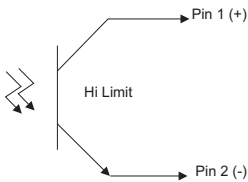

Figure 3

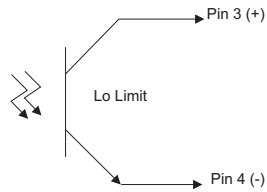

Figure 4

Interval Time Setting

To set up the interval time for the log function, press the [INVT] button. The indicator "INV" will blink at the top right of the LCD and previous settings are displayed. Press the number buttons (printed in white) on the overlay to change the time setting. Setting changes from left to right in the following format: HH:MM:SS. Press the ENTER button to confirm. Press the "ESC" button to exit this function.

HH: 0-23

MM: 0-59

SS: 0-59

MAX: 23:59:59

MIN: 00:00:01

Auto Power Off Time Setting

Press the [APO] button in Setup Mode. The indicator "APO" and the main display will blink on the LCD showing the previous setting. Press the number buttons (printed in white) on the overlay to change the APO time. Press the ENTER button to confirm. To exit this function without changing the setting, press the ESC button.

MAX: 19999 minutes

MIN: 0005 minutes

Thermocouple Offset Adjustment

To change the offset for T1, the main display input should be set to T1. Set the main display to T2 for adjusting the offset to T2. Press the [OFS] button to enter the offset adjustment mode. "CAL" will be displayed on the top right of the LCD and the main display will blink showing the previous setting. Press the number buttons (printed in white) on the overlay to change the offset. The resolution is 0.1°. Use the "-" button to set a negative value. Press the ENTER button to confirm.

MAX: $\pm 1999.9^{\circ}\text{C}/^{\circ}\text{F}$

System Time Setting

To set or change the system time, press the [TIME] button in Setup Mode. The time and date in the bottom right display will blink. Enter from left to right YY:MM:DD and HH:MM:SS. Press the number buttons (printed in white) on the overlay to change the settings. Press the ENTER button to confirm. Exit this function by pressing the ESC button.

Error messages:

If **Err-02**, **Err-02** or **Err-03** appears in the display, one of the following conditions has occurred:

Err-01: In the "SAVE" mode, the maximum recording range is 128 samples. The lower right display will show **Err-01** if the maximum capacity of 128 samples has been reached.

Err-02: In the "LOG" mode, the maximum recording is $16 \times 64 = 1024$ samples. The lower right display will show **Err-02** if the maximum capacity of the 16 groups has been reached.

Err-03: In the "READ LOG" and "READ SAVE" mode, when the main display shows 6028 and the lower right display shows "**OL, Err-03**", one of the following conditions has occurred::

1. There is no data in the memory.
2. The memory is full, and the meter will warn the user this is the last sample.

SAVE=128 samples

LOG=1024 samples

RS-232 PC Interface

The Model 421509 Thermometer is supplied with a sophisticated Windows® software package on disk. A communications cable (meter to PC) is also supplied. The program allows the user to operate the meter remotely and view the readings from all three LCD fields on the PC monitor. The software also permits measurement data to be stored as text files on a PC. The data files can then be exported to spreadsheet or other programs for further manipulation (graphing, sorting, filing, etc.).

Connecting the Meter to a PC

Connect the Optical Interface connector to the 421509 Thermometer. The “IR2” label should be facing up. Connect the 9-pin female connector to the 9-pin serial PC port (COM1-4).

PC Requirements

- 486-33 IBM compatible PC or better
- One CD-ROM drive
- Available serial port.
- Windows 95, 98, 2000, NT, ME, XP Operating System

Installing the Windows Application Program

1. Place the supplied software CD in the PC CD-ROM drive and run setup.exe
2. Change the path if necessary or choose the “Finish” button to install the program to its default location.
3. Launch the program by double clicking the program file in the location where it was saved during installation.
4. Remember not to run the supplied software until the meter is properly connected to the PC as described earlier.

Software Control Panel Description



Button	Description
T1 INPUT	Open the T1 input control window to activate function
T2 INPUT	Open the T2 input control window to activate function
T1-T2	Open the T1-T2 control window to activate function
RECORD	Open the recording control window to activate data acquisition
READ DATA	Downloads the logged data from the meter
START	Press the “START” button to activate the meter’s serial port output and then the auto-power-off function will be disabled.
STOP	Press the “STOP” button to stop the meter’s serial port output and then the auto-power-off function will be enabled.
WORKING	The “WORKING” sign will blink when the meter is communicating with the PC, otherwise “RS-232ERR” will be displayed.
COM PORT	Select serial port (COM1 to 4)

Operation

1. Select the correct COM port
2. Press the "START" button
3. Press the T1 INPUT, T2 INPUT or T1-T2 button to open the control window

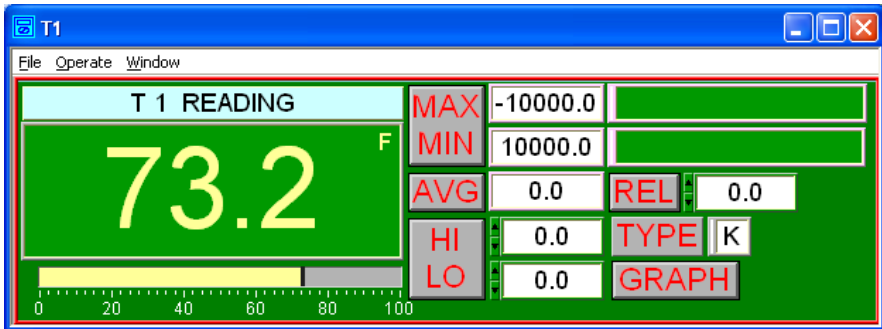

Button

MAX MIN

AVG

REL

HI/LO

TYPE

GRAPH

Description

Activate Max/Min reading with time

Activate Average reading measurement

Activate Relative mode

Activate Hi/Lo limit comparative mode. The limit will also be visible on the graphical display as red (HI) and blue (LO) horizontal lines. The display value will blink between red and blue when the input temperature value exceeds the LO value.

Select the K/J/T/E/R/S/N type thermocouple

Open the graph sub-window

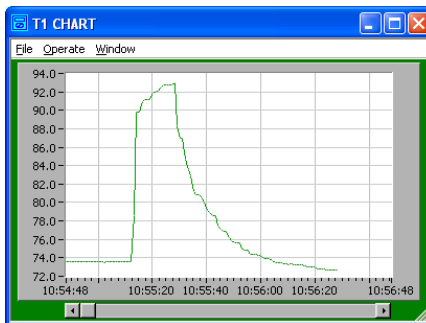

Record Function (Data Acquisition)

Button	Description
FILE NAME	Select Default or User Name for Data Acquisition
USER FILE	Saved in .xls format
INTV	Sample rate from 1 to 65535
LIST	Enter the number of the lines from 200 to 65535
CLR	Clears the screen
REC	Starts data acquisition/Press OFF to stop recording

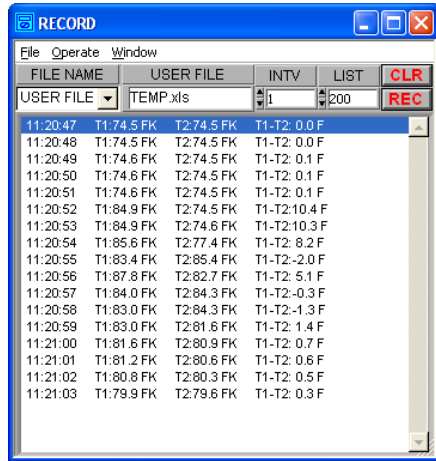

Importing Data from the Meter

1. Click the READ DATA button
2. The window will open and the data stored in the meter's memory will automatically download to the PC. A red bar at the bottom of the screen will indicate the download progress.
3. After the download is complete, select the Log Data tab to open the log window to retrieve datalogged measurements, or Saved Data to open the save window for manually stored data retrieval
4. Click the Query button to open the data
5. Switch from Table to Diagram view if desired
6. Click on the File menu to save the data as text or xls (Excel) format

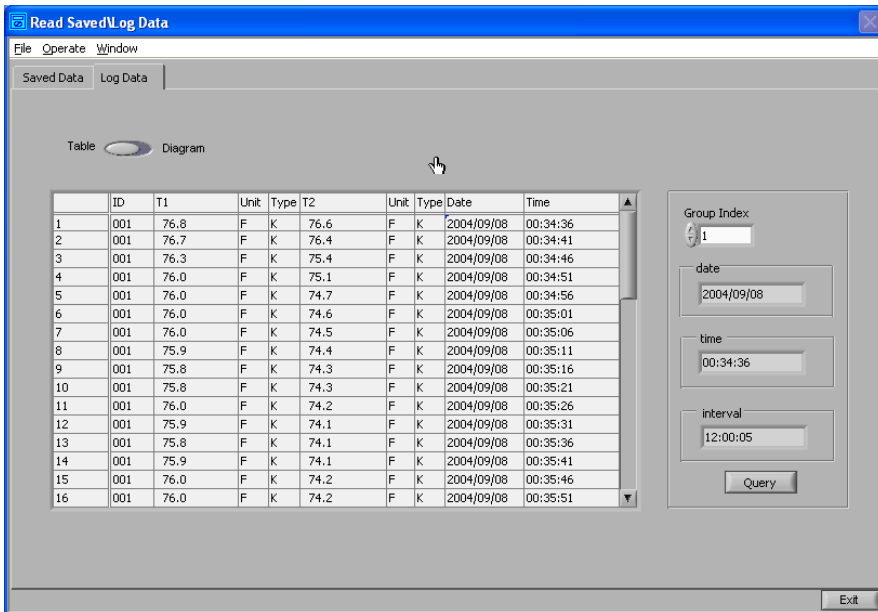

Battery Replacement

Replace the battery when the low battery indication symbol appears on the upper left corner of the display. To replace the battery, remove the protective rubber holster to access the battery compartment. Remove the two screws that secure the rear battery compartment cover. Remove the old battery, install a new one, and replace cover.

Calibration and Repair Services

Extech offers complete repair and calibration services for all of the products we sell. For periodic calibration, NIST certification or repair of any Extech product, call customer service for details on services available. Extech recommends that calibration be performed on an annual basis to ensure calibration integrity.

Warranty

EXTECH INSTRUMENTS CORPORATION warrants this instrument to be free of defects in parts and workmanship for one year from date of shipment (a six month limited warranty applies on sensors and cables). If it should become necessary to return the instrument for service during or beyond the warranty period, contact the Customer Service Department at (781) 890-7440 ext. 210 for authorization or visit our website at www.extech.com (click on 'Contact Extech' and go to 'Service Department' to request an RA number). A Return Authorization (RA) number must be issued before any product is returned to Extech. The sender is responsible for shipping charges, freight, insurance and proper packaging to prevent damage in transit. This warranty does not apply to defects resulting from action of the user such as misuse, improper wiring, operation outside of specification, improper maintenance or repair, or unauthorized modification. Extech specifically disclaims any implied warranties or merchantability or fitness for a specific purpose and will not be liable for any direct, indirect, incidental or consequential damages. Extech's total liability is limited to repair or replacement of the product. The warranty set forth above is inclusive and no other warranty, whether written or oral, is expressed or implied.



Support line (781) 890-7440

Technical support: Extension 200; E-mail: support@extech.com

Repair & Returns: Extension 210; E-mail: repair@extech.com

Product specifications subject to change without notice

For the latest version of this User's Guide, Software updates, and other up-to-the-minute product information, visit our website: www.extech.com

**Copyright © 2007 Extech Instruments Corporation. All rights reserved
including the right of reproduction in whole or in part in any form.**