

PANEL INDICATOR LEDs - Ø8.0mm Mounting

## FEATURES

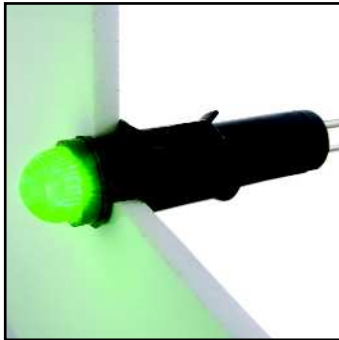

### 411 SERIES

PACK QUANTITY = 20 PIECES

- Front panel replaceability
- Must be used in conjunction with 907-000-00 panel socket. See datasheet DS084/04
- Domed fresnel lens for wide angle viewing
- Sealed to IP40
- Product illustrated 411-532-22 in the 907-000-00 panel mounting socket

## SPECIFICATIONS

Ordering Information & Typical Technical Characteristics (Ta = 25°C)

Mean Time Between Failure Typically = 100,000 Hours. Luminous intensity figures refer to the unmodified discrete LED.

PART NUMBER	COLOUR	LENS	VOLTAGE DC Vopr	CURRENT DC Iopr	LUMINOUS INTENSITY Iv@20mA	WAVE LENGTH λp	OPERATING TEMP Topr	STORAGE TEMP Tstg		
<b>HIGH INTENSITY</b>										
411-501-21	Red		Colour Diffused	12	20	11000	643	-0 ~ +85 <sup>^</sup>	-0 ~ +85	Yes
411-521-21	Yellow		Colour Diffused	12	20	16000	591	-0 ~ +85 <sup>^</sup>	-0 ~ +85	Yes
411-532-21	Green		Colour Diffused	12	20	23000	527	-0 ~ +85 <sup>^</sup>	-0 ~ +85	Yes
411-930-21	Blue		Colour Diffused	12	20	7000	470	-0 ~ +85 <sup>^</sup>	-0 ~ +85	Yes
411-997-21	Cold White		Colour Diffused	12	20	14000	*see below	-0 ~ +85 <sup>^</sup>	-0 ~ +85	Yes
411-501-23	Red		Colour Diffused	24-28	17.5	11000	643	-0 ~ +85 <sup>^</sup>	-0 ~ +85	Yes
411-521-23	Yellow		Colour Diffused	24-28	17.5	16000	591	-0 ~ +85 <sup>^</sup>	-0 ~ +85	Yes
411-532-23	Green		Colour Diffused	24-28	17.5	23000	527	-0 ~ +85 <sup>^</sup>	-0 ~ +85	Yes
411-930-23	Blue		Colour Diffused	24-28	17.5	7000	470	-0 ~ +85 <sup>^</sup>	-0 ~ +85	Yes
411-997-23	Cold White		Colour Diffused	24-28	17.5	14000	*see below	-0 ~ +85 <sup>^</sup>	-0 ~ +85	Yes
<b>UNITS</b>			<b>Vdc</b>	<b>mA</b>	<b>mcd</b>	<b>nm</b>	<b>°C</b>	<b>°C</b>		



<b>997F-C</b>	*Typical emission colour cold white				Intensities (Iv) and colour shades of white (x,y co-ordinates) may vary between LEDs within a batch.
x	0.245	0.361	0.356	0.264	
y	0.229	0.385	0.351	0.220	

<sup>^</sup> = Products must be derated according to the derating information. Each derating graph refers to specific LEDs. Appropriate LED numbers shown. Refer to page 3.

### How to Order:

website: [www.marl.co.uk](http://www.marl.co.uk) • email: [sales@marl.co.uk](mailto:sales@marl.co.uk) •

• Telephone +44 (0)1229 582430 • Fax: +44 (0)1229 585155

The information contained in this datasheet does not constitute part of any order or contract and should not be regarded as a representation relating to either products or service. Marl International reserve the right to alter without notice the specification or any conditions of supply for products or service.

### 411 SERIES

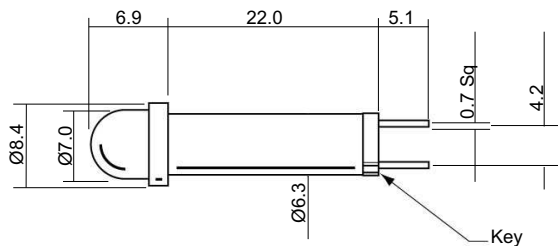

Dimensions in mm (Typical)  
Not to scale

Key denotes cathode

### MATERIALS

Body	Nylon 6
Termination Pins	Tin on Nickel Plated Phosphor Bronze
Fresnel lens	Polycarbonate
Header	Nylon 6
Rear Retainer	Spring Steel
Mounting Hardware	Use with socket 907-000-00. Use with socket 908-000-00 when diode test facility is specified

### TECHNICAL CHARACTERISTICS

SERIES	MAXIMUM POWER DISSIPATION	MAXIMUM REVERSE VOLTAGE	PANEL CUTOUT	MINIMUM MOUNTING CENTRES	MIN/MAX. PANEL THICKNESS
411	500	3	8.0	17.0	13.0
UNITS	mW	Vdc	mm	mm	mm

### PANEL SOCKETS & CONNECTORS

909-000-00 is gold plated  
910-000-00 is tin plated  
for use with 907 and 908 series panel sockets.

Suitable for wire sizes from 0.15mm<sup>2</sup> to 0.38mm<sup>2</sup> cross sectional area.

Dual metal contact design provides low resistance and gas tight electrical contact.

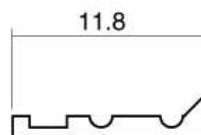

Dimensions in mm (Typical)  
Not to scale

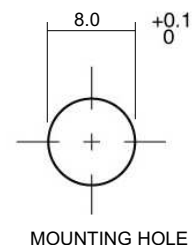
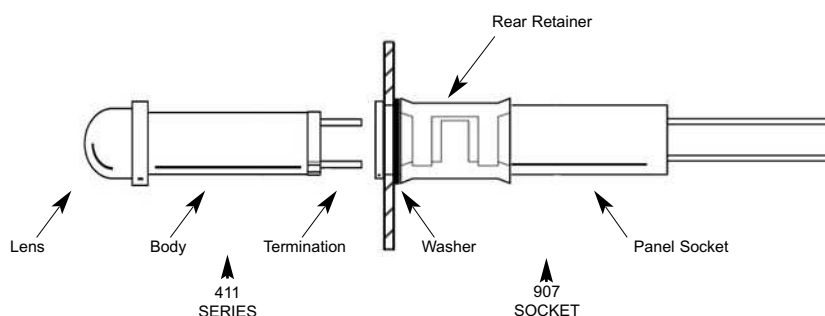

Mounting hole to be clean and burr free

#### How to Order:

website: [www.marl.co.uk](http://www.marl.co.uk) • email: [sales@marl.co.uk](mailto:sales@marl.co.uk) •

• Telephone +44 (0)1229 582430 • Fax: +44 (0)1229 585155

The information contained in this datasheet does not constitute part of any order or contract and should not be regarded as a representation relating to either products or service. Marl International reserve the right to alter without notice the specification or any conditions of supply for products or service.



BS EN ISO 9001:2000  
Approved Manufacturer

### Optional Reverse Protection Diode

ORDER CODE SUFFIX	CIRCUIT	COMMENTS
01		Available on all indicators except Bi-Colour devices and when diode test is specified.

### Optional Diode Test Facility

ORDER CODE SUFFIX	TERMINATION	CIRCUIT	COMMENTS
03	3 PIN 908-000-00 Socket	TEST POSITIVE	Not available with Bi-colour LED
05	150mm of flying leads colours as shown (attached to 908-000-00)		
09	1000mm of flying leads colours as shown (attached to 908-000-00)		
04	3 PIN 908-000-00 Socket	TEST NEGATIVE	
06	150mm of flying leads colours as shown (attached to 908-000-00)		
10	1000mm of flying leads colours as shown (attached to 908-000-00)		

#### Test Positive

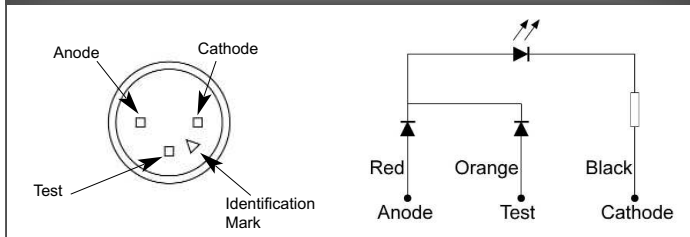

#### Test Negative

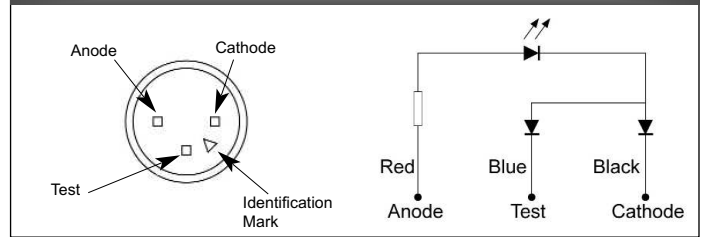

### De-rating Information

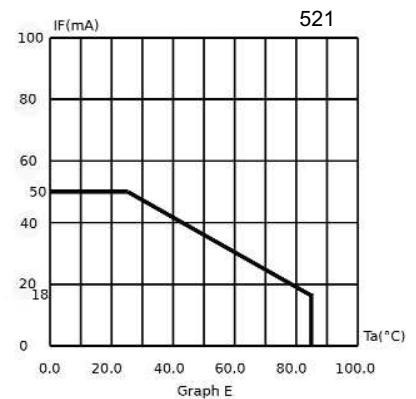
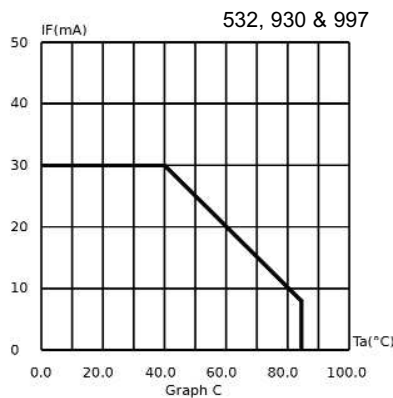
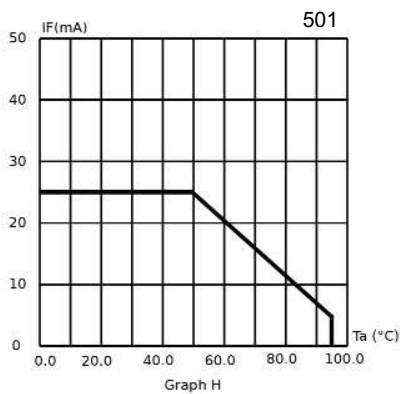

#### How to Order:

website: [www.marl.co.uk](http://www.marl.co.uk) • email: [sales@marl.co.uk](mailto:sales@marl.co.uk) •

• Telephone +44 (0)1229 582430 • Fax: +44 (0)1229 585155

The information contained in this datasheet does not constitute part of any order or contract and should not be regarded as a representation relating to either products or service. Marl International reserve the right to alter without notice the specification or any conditions of supply for products or service.



BS EN ISO 9001:2000  
Approved Manufacturer

## 411 Series

Part numbers also available in the 411 Series:

PART NO.	COLOUR	VOLTAGE (Vdc) Vopr
411-000-22-50	Red/Yellow	24Vdc
411-501-04	Red	20mA
411-501-04-03	Red	20mA
411-501-22	Red	24Vdc
411-501-22-03	Red	24Vdc
411-501-22-04	Red	24Vdc
411-501-24	Red	48Vdc
411-501-24-03	Red	48Vdc
411-501-24-04	Red	48Vdc
411-501-75	Red	110Vac
411-501-75-03	Red	110Vac
411-501-76	Red	230Vac
411-503-20	Red	5/6Vdc
411-503-20-03	Red	5/6Vdc
411-503-21	Red	12Vdc
411-503-21-04	Red	12Vdc
411-503-22	Red	24Vdc
411-503-22-03	Red	24Vdc
411-503-22-04	Red	24Vdc
411-503-22-05	Red	24Vdc
411-503-22-50	Red	24Vdc
411-503-22-51	Red	24Vdc
411-503-23	Red	24-28Vdc
411-503-24-03	Red	48Vdc
411-503-76	Red	230Vac
411-506-20-03	Orange	5/6Vdc
411-506-22	Orange	24Vdc
411-506-22-03	Orange	24Vdc
411-506-22-04	Orange	24Vdc
411-506-22-51	Orange	24Vdc
411-506-23	Orange	24-28Vdc
411-506-75	Orange	110Vac
411-506-76-15	Orange	230Vac
411-509-20	Yellow	5/6Vdc
411-509-21	Yellow	12Vdc
411-509-21-50	Yellow	12Vdc
411-509-22	Yellow	24Vdc
UNITS		

PART NO.	COLOUR	VOLTAGE (Vdc) Vopr
411-509-22-03	Yellow	24Vdc
411-509-22-04	Yellow	24Vdc
411-509-22-05	Yellow	24Vdc
411-509-22-52	Yellow	24Vdc
411-509-23	Yellow	24-28Vdc
411-512-20	Green	5/6Vdc
411-512-21	Green	12Vdc
411-512-21-04	Green	12Vdc
411-512-22	Green	24Vdc
411-512-22-03	Green	24Vdc
411-512-22-04	Green	24Vdc
411-512-22-05	Green	24Vdc
411-512-22-51	Green	24Vdc
411-512-24-03	Green	48Vdc
411-519-22	Blue	24Vdc
411-519-22-03	Blue	24Vdc
411-519-22-50	Blue	24Vdc
411-521-22	Yellow	24Vdc
411-521-22-03	Yellow	24Vdc
411-521-22-04	Yellow	24Vdc
411-521-24-04	Yellow	48Vdc
411-521-76-13	Yellow	230Vac
411-532-04	Green	20mA
411-532-22	Green	24Vdc
411-532-22-03	Green	24Vdc
411-532-22-04	Green	24Vdc
411-532-24-03	Green	48Vdc
411-532-76	Green	230Vac
411-532-76-13	Green	230Vac
411-532-76-15	Green	230Vac
411-930-22	Blue	24Vdc
411-930-22-03	Blue	24Vdc
411-930-22-50	Blue	24Vdc
411-997-22	White	24Vdc
411-997-22-03	White	24Vdc
411-997-43	White	18Vdc
411-997-76	White	230Vac
UNITS		

The products listed above illustrate all of the options available to order. These products may have custom modifications that alter their operation beyond the generic information contained within this datasheet. Please contact sales for further information.

### How to Order:

website: [www.marl.co.uk](http://www.marl.co.uk) • email: [sales@marl.co.uk](mailto:sales@marl.co.uk) •

• Telephone +44 (0)1229 582430 • Fax: +44 (0)1229 585155

The information contained in this datasheet does not constitute part of any order or contract and should not be regarded as a representation relating to either products or service. Marl International reserve the right to alter without notice the specification or any conditions of supply for products or service.



BS EN ISO 9001:2000  
Approved Manufacturer