

User's Manual

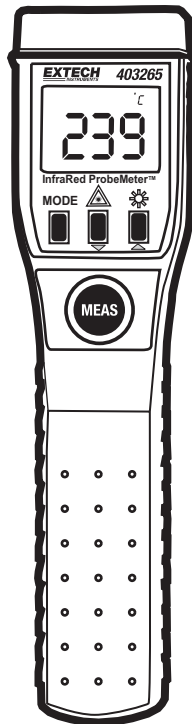

Non-Contact Infrared Thermometer

Model 403265



Introduction

Congratulations on your purchase of the Extech 403265 IR Thermometer. This thermometer provides contact free temperature measurements with built-in laser pointer. Careful use of this meter will provide years of reliable service.



WARNING!

The Laser button  enables/disables the Laser function. When enabled, each press of the MEAS button triggers the Laser beam. Avoid looking directly into the path of the Laser or pointing the Laser toward anyone's eyes. Mirrored surfaces near a measurement object can redirect the Laser, use extreme caution. Do not allow the Laser beam to be directed toward explosive gases.

Meter Description

1. Infrared sensor (top)
2. Laser source (top)
3. LCD Temperature Display
4. Mode button
5. Laser pointer and Down arrow button
6. Backlight and Up arrow button
7. Measure button (MEAS)

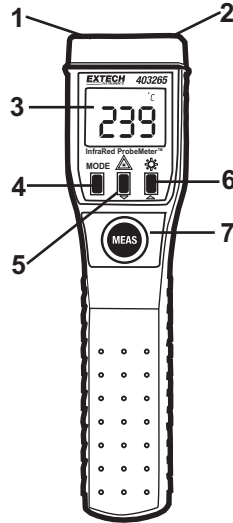

Note: Battery compartment is on rear of meter

Specifications

Range/Resolution	-4 to 1022°F/(1°F) 0 to 199°C/(0.5°C); -20 to 0°C/200 to 550°C/(1°C)
Accuracy	±2% of reading or ± 6°F/3°C (whichever is greater) (@ 64.4 to 82.4°F (18 to 28°C) ambient temperature)
Temperature Coefficient	A ±0.2% of reading or ±0.36°F (0.2°C) (whichever is greater) change in accuracy per °F/°C change in ambient temperature > 82.4°F(28°C) or < 64.4°F (18°C)
Display	3-1/2 digit (2000 count) backlit LCD with over-range and low battery indication
Measurement rate	1 reading per second
Response time	1 second
Spectral Response	6 to 14 μm nominal
Emissivity	Adjustable from 0.10 to 1.00 (in 0.01 steps)
Detection element	Thermopile
Optical lens	Fresnel Lens
Laser pointer	Color: Red (670nm) Power: <1mW class II
Field of view	D/S = Approx. 10:1 ratio (D = distance, S = spot)
Operating conditions	32 to 122°F (0 to 50°C) and < 70% relative humidity
Storage conditions	-4 to 140°F (0 to 60°C) and < 80% relative humidity
Auto Power off	After 20 seconds of inactivity
Standby consumption	< 5mA
Power supply	Four (4) 'AAA' 1.5 V batteries
EMC	Instrument unspecified for use in EMC field > 0.5V/m
Battery life	60 hours (continuous) typical with carbon-zinc battery (laser pointer and backlight off)
Dimensions / Weight	6.7 x 1.7 x 1.6" (170 x 44 x 40mm) / 5.6 oz.(160g)

Field of View

The meter's field of view is 10:1; For example, if the meter is 10 inches from the target, the diameter of the object under test must be at least 1 inch. The object under test should actually be larger than the spot size shown in the diagram below. The smaller the target, the closer the meter should be to the target. As the distance from the target increases, the area measured by the meter (spot) becomes larger.

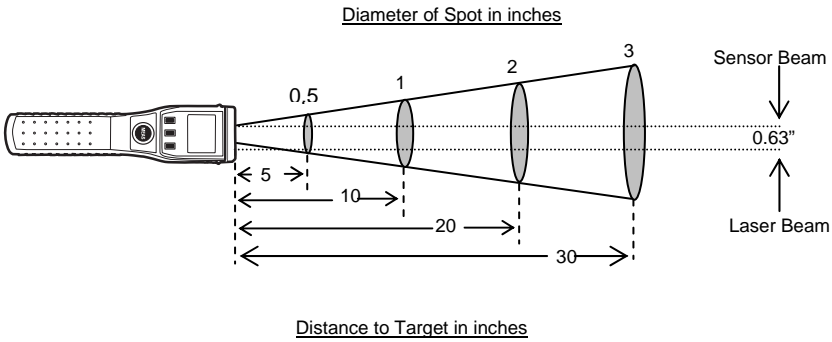

Operation

CAUTION!

1. Strong electromechanical radiation or static discharges can cause reading errors if situated near the meter.
2. An explosion potential exists if the meter is exposed to corrosive or explosive gases.
3. Avoid high humidity, direct sunlight, high temperature, or condensation when measuring.
4. Do not point the laser beam into direct sunlight or other source of strong light.
5. Do not touch the meter's lens and do not allow the object tested to touch the lens.
6. Do not place the meter on a hot surface ($> 158^{\circ}\text{F} / 70^{\circ}\text{C}$)
7. If the meter is exposed to significant changes in ambient temperature (hot to cold or cold to hot), allow 20 minutes for the meter to stabilize before taking measurements.
8. This unit is not dust-proof or water-proof. Use caution when using and storing the meter.

Power ON

The meter is powered by four (4) AAA 1.5V batteries (rear battery compartment). Press the red MEAS button to turn power on. The meter does not have an OFF button, it automatically powers down after 20 seconds to preserve battery life.

Taking Readings

There are two modes of operation, the Standard Mode and the Continuous Mode. In the Standard Mode, the meter will measure and update the display while the MEAS button is depressed. In the Continuous Mode, the meter will continuously measure and update the display after the MEAS button is pressed once (auto-power off is disabled). Pressing the MEAS button again will enable the HOLD function and the meter will turn off after 20 seconds.

Hold the MODE button down while turning power ON to toggle between the two modes.

Standard Measurement Mode

1. Point the meter toward the device under test
2. Press and hold the MEAS button and allow the reading to stabilize on the LCD display
3. Release the MEAS button. The stabilized reading will now be held on the LCD. 'HOLD' will appear on the LCD to indicate that the reading is being held
4. Press the MEAS button to take another measurement
5. The meter will automatically power off after 20 seconds of inactivity

Continuous Measurement Mode

1. Point the meter toward the device under test
2. Press the MEAS button to toggle between MEASURE and HOLD
3. The meter will automatically turn OFF after 20 seconds in the HOLD function, it will remain ON in the MEASURE function.



LCD Backlight

Use the backlight button  to enable or disable the LCD backlight feature. When activated, the backlight turns on each time the MEAS button is pressed (it automatically turns off to preserve the batteries).

Laser Pointer

The Laser is used to help aim the IR sensor. The Laser button (center) enables the Laser Pointer feature. When enabled, the meter emits the red laser beam each time the MEAS button is pressed. A triangle with a black circle appears in the top left of the LCD to let the user know that the Laser function is enabled. The triangle display icon is cleared when the Laser feature is disabled. Note that the Laser pointer beam and the IR sensor beam are separated by 0.63 inches (Refer to the Field of View diagram).

°C/°F Select

With the meter off, press and hold the backlight button  then press the MEAS button to select degrees F. With the meter off, press and hold the laser button  then press the MEAS button to select degrees C.

MODE Button

Pressing the MODE button while HOLD is active accesses the configuration mode. The following parameters can be configured: Emissivity value, High Alarm setpoint (ALM Hi), Low Alarm setpoint (ALM Lo), Maximum reading (MAX), and Minimum reading (MIN).

Emissivity Adjust

1. In the HOLD mode, press the MODE button
2. Use the UP/DOWN arrow buttons to set the desired emissivity from 0.10 to 1.00. The normal value is 0.95.

High Alarm Set Point

1. In the HOLD mode, press the MODE button two times. "ALMHi" will appear in the display.
2. Use the UP/DOWN arrow buttons to set the desired Hi Alarm set point.

Low Alarm Set Point

1. In the HOLD mode, press the MODE button three times. "ALM Lo" will appear in the display.
2. Use the UP/DOWN arrow buttons to set the desired Lo Alarm set point.

MAX/MIN

1. In the HOLD mode, press the MODE button four (MAX) & five (MIN) times to view the highest (MAX) and lowest (MIN) temperatures measured since the meter was last turned on.
2. In the Measure mode, press the MODE button to step through the highest (MAX), lowest (MIN) and current temperature.

Measurement Notes

1. The object under test should be larger than the spot size calculated by the field of view diagram (see Field of View diagram above).
2. If the surface of the object under test is covered with frost, oil, grime, etc., clean before taking measurements.
3. If an object's surface is highly reflective apply masking tape or flat black paint before measuring.
4. The meter cannot measure through transparent surfaces such as glass.
5. Steam, dust, smoke, etc. can obscure accurate measurements.
6. The meter compensates for deviations in ambient temperature. It can, however, take up to 30 minutes for the meter to adjust to extremely wide temperature changes.
7. To find a hot spot, aim the meter outside the area of interest then scan across (in an up and down motion) until the hot spot is located.

Emissivity Note

Most organic materials and painted or oxidized surfaces have an emissivity factor of 0.95. Inaccurate readings will result from measuring shiny or polished metal surfaces which have emissivity factors other than 0.95. To compensate for polished/shiny surfaces, cover the surface with masking tape or flat black paint. Allow time, before measuring, for the tape to reach the same temperature as the material underneath it.

Emissivity Factors for Common Materials

Material under test	Emissivity	Material under test	Emissivity
Asphalt	0.90 to 0.98	Cloth (black)	0.98
Concrete	0.94	Skin (human)	0.98
Cement	0.96	Lather	0.75 to 0.80
Sand	0.90	Charcoal (powder)	0.96
Soil	0.92 to 0.96	Lacquer	0.80 to 0.95
Water	0.92 to 0.96	Lacquer (matt)	0.97
Ice	0.96 to 0.98	Rubber (black)	0.94
Snow	0.83	Plastic	0.85 to 0.95
Glass	0.90 to 0.95	Timber	0.90
Ceramic	0.90 to 0.94	Paper	0.70 to 0.94
Marble	0.94	Chromium Oxides	0.81
Plaster	0.80 to 0.90	Copper Oxides	0.78
Mortar	0.89 to 0.91	Iron Oxides	0.78 to 0.82
Brick	0.93 to 0.96	Textiles	0.90

Battery Replacement

When the low battery symbol  appears on the LCD, replace the meter's four (4) AAA 1.5V batteries. The battery compartment is located on the rear of the meter. Open the compartment by removing the screw and sliding the battery compartment cover off in the direction of the arrow. Replace batteries observing polarity and re-install the battery compartment cover.

Warranty

EXTECH INSTRUMENTS CORPORATION warrants this instrument to be free of defects in parts and workmanship for one year from date of shipment (a six month limited warranty applies on sensors and cables). If it should become necessary to return the instrument for service during or beyond the warranty period, contact the Customer Service Department at (781) 890-7440 ext. 210 for authorization or visit our website at www.extech.com (click on 'Contact Extech' and go to 'Service Department' to request an RA number). A Return Authorization (RA) number must be issued before any product is returned to Extech. The sender is responsible for shipping charges, freight, insurance and proper packaging to prevent damage in transit. This warranty does not apply to defects resulting from action of the user such as misuse, improper wiring, operation outside of specification, improper maintenance or repair, or unauthorized modification. Extech specifically disclaims any implied warranties or merchantability or fitness for a specific purpose and will not be liable for any direct, indirect, incidental or consequential damages. Extech's total liability is limited to repair or replacement of the product. The warranty set forth above is inclusive and no other warranty, whether written or oral, is expressed or implied.

Calibration and Repair Services

Extech offers complete repair and calibration services for all of the products we sell. For periodic calibration, NIST certification or repair of any Extech product, call customer service for details on services available. Extech recommends that calibration be performed on an annual basis to ensure calibration integrity.



Support line (781) 890-7440

Technical support: Extension 200; E-mail: support@extech.com

Repair & Returns: Extension 210; E-mail: repair@extech.com

Product specifications subject to change without notice

For the latest version of this User's Guide, Software updates, and other up-to-the-minute product information, visit our website: www.extech.com

**Copyright © 2004 Extech Instruments Corporation.
All rights reserved including the right of reproduction in whole or in part in any form.**