



424 Series

10 Hz to 102.4 kHz
4-Bit Programmable

32-Pin DIP
4-Pole Filters

Description

The 424 Series are 4-pole digitally programmable low-pass and high-pass active filters. These new filters take advantage of the company's proprietary designs using surface-mount technology to provide a low profile, compact package in minimal board space. 424 filters are factory tuned to one of ten preset 4-bit binary ranges from 10 Hz to 102.4 kHz. Contact the factory for custom discrete tuning ranges, maximum span 1000:1.

All 424 Series models are easy to use fully finished filters which require no external components or adjustment. They feature low harmonic distortion, near theoretical phase and amplitude characteristics and operate over a dynamic input voltage range from non-critical $\pm 12V$ to $\pm 18V$ power supplies.

Features/Benefits:

- Low harmonic distortion and wide signal-to-noise ratio to 16-bit resolution.
- Compact 1.8"L x 0.8"W x 0.3"H min. (32-pin DIP footprint) minimizes board space requirements.
- Digitally programmable corner frequency allows selecting cut-off frequencies specific to each application.
- Plug-in ready-to-use, reducing engineering design and manufacturing cycle time.
- Factory tuned, no external clocks or adjustments needed
- Broad range of transfer characteristics and corner frequencies to meet a wide range of applications.

Applications

- Anti-alias filtering
- Data acquisition systems
- Communication systems and electronics
- Medical electronics equipment and research
- Aerospace, navigation and sonar applications
- Acoustic and vibration analysis and control
- Real and compressed time data analysis
- Noise elimination
- Signal reconstruction



Programmable Specifications	Page
Digital Tuning & Control	2
Available Low-Pass Models:	
424L4B 4-pole Butterworth	3
424L4L 4-pole Bessel	3
424L4Y2 4-pole Cheby (0.2 dB Ripple)	3
424L4Y5 4-pole Cheby (0.5 dB Ripple)	3
Available High-Pass Models:	
424H4B 4-pole Butterworth	4
424H4Y2 4-pole Cheby (0.2 dB Ripple)	4
424H4Y5 4-pole Cheby (0.5 dB Ripple)	4
General Specifications:	
Ordering information	5
Pin-out/package data	5



4-Bit Programmable Filters

Digital Tuning Characteristics

The digital tuning interface circuits are a parallel set of CMOS switches which accept CMOS compatible inputs for the four tuning bits ($D_0 - D_3$).

Binary Tuning Range

MSB	---	---	LSB	Bit Weight
2^3 D_3	2^2 D_2	2^1 D_1	2^0 D_0	fc - corner frequency
0	0	0	0	$f_{max}/16$
0	0	0	1	$f_{max}/8$
0	0	1	1	$f_{max}/4$
0	1	1	1	$f_{max}/2$
1	1	1	1	f_{max}

Binary Tuning Equation:

$$fc = (f_{max}/16) [1 + D_3 \times 2^3 + D_2 \times 2^2 + D_1 \times 2^1 + D_0 \times 2^0]$$

where $D_1 - D_3 = "0"$ or $"1"$, and

f_{max} = Maximum tuning frequency

fc = Corner frequency;

Minimum tunable frequency = $f_{max}/16$ (D_0 thru $D_3 = 0$);

Minimum frequency step (Resolution) = $f_{max}/16$

Discrete Frequencies

F	D_0	D_1	D_2	D_3
F_B	0	0	0	0
F_1	1	0	0	0
F_2	1	1	0	0
F_3	1	1	1	0
F_4	1	1	1	1

Discrete Tuning Equation:

$$fc = F_B + D_0[f_0] + D_1[f_1] + D_2[f_2] + D_3[f_3]$$

f_0, f_1, f_2, f_3 are the incremental frequency shifts for the data bits D_0, D_1, D_2 and D_3 . They are selected to realize the five

customer specified programming frequencies $F_B \rightarrow F_4$. Other programming codes produce valid fc's between F_B and F_4 .

Pin-Out Key

IN	Analog Input Signal	D_3	Tuning Bit 3 (MSB)
OUT	Analog Output Signal	D_2	Tuning Bit 2
GND	Power and Signal Return	D_1	Tuning Bit 1
+Vs	Supply Voltage, Positive	D_0	Tuning Bit 0 (LSB)
-Vs	Supply Voltage, Negative	+5V	Logic Power
Os	Offset Adjustment		

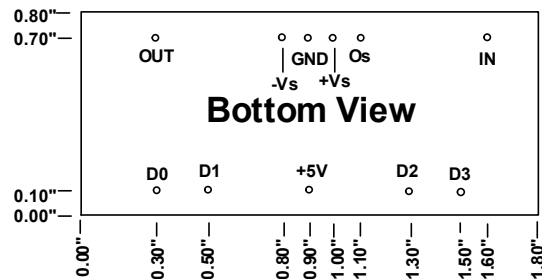

Data Input Specifications

Input Data Levels

(+5Vdc CMOS Logic)

Input Voltage ($V_{s=15}$ Vdc)

Low Level In	0 Vdc min.	0.5 Vdc max.
High Level In	3.5 Vdc min.	5.0 Vdc max.

Input Current

High Level In	-0.4mA typ.	-2.0mA max.
Low Level In	+0.4mA typ.	+2.0mA max.

Input Capacitance

20 pF typ.	30 pF max.
------------	------------

Input Data Format

Positive Logic

Frequency Select Bits

Logic "1" = (+5Vdc)
Logic "0" = Gnd

Bit Weight

D_0	LSB (least significant bit)
D_3	MSB (most significant bit)

Frequency Range 16:1 Binary Weighted



4-Bit Programmable

4-Pole Low-Pass Filters

Model	424L4B	424L4L	424L4Y2	424L4Y5
Product Specifications				
Transfer Function	4-Pole, Butterworth	4-Pole, Bessel	4-Pole, Chebychev, 0.2 dB Ripple	4-Pole, Chebychev, 0.5 dB Ripple
Size	0.8" x 1.8" x 0.3"	0.8" x 1.8" x 0.3"	0.8" x 1.8" x 0.3"	0.8" x 1.8" x 0.3"
Range f_c	10.0 Hz to 102.4 kHz	10.0 Hz to 102.4 kHz	10.0 Hz to 102.4 kHz	10.0 Hz to 102.4 kHz
Theoretical Transfer Characteristics	Appendix A Page 7	Appendix A Page 2	Appendix A Page 12	Appendix A Page 15
Passband Ripple (theoretical)	0.0 dB	0.0 dB	0.20 dB	0.50 dB
DC Voltage Gain (non-inverting)	0 ± 0.1 dB max. 0 ± 0.05 dB typ.	0 ± 0.1 dB max. 0 ± 0.05 dB typ.	0 ± 0.1 dB max. 0 ± 0.05 dB typ.	0 ± 0.1 dB max. 0 ± 0.05 dB typ.
Stopband Attenuation Rate	24 dB/octave	24 dB/octave	24 dB/octave	24 dB min.
Cutoff Frequency Stability	f_c ± 2% max. ± 0.01% /°C	f_c ± 2% max. ± 0.01% /°C	f_c ± 2% max. ± 0.01% /°C	f_c ± 2% max. ± 0.01% /°C
Amplitude Phase	-3 dB -180°	-3 dB -121°	-3 dB -231°	-3 dB -245°
Filter Attenuation (theoretical)	0.67 dB 0.80 f_c 3.01 dB 1.00 f_c 30.0 dB 2.37 f_c 40.0 dB 3.16 f_c	1.86 dB 0.80 f_c 3.01 dB 1.00 f_c 30.0 dB 3.50 f_c 40.0 dB 4.72 f_c	-0.20 dB 0.80 f_c 3.01 dB 1.00 f_c 30.0 dB 1.89 f_c 40.0 dB 2.46 f_c	-0.43 dB 0.80 f_c 3.01 dB 1.00 f_c 30.0 dB 1.80 f_c 40.0 dB 2.33 f_c
Phase Match¹	0 - 0.8 f_c ± 2° max. ± 1° typ. 0.8 f_c - 1.0 f_c ± 3° max. ± 1.5° typ.	0 - f_c ± 2° max. ± 1° typ.	0 - 0.8 f_c ± 2° max. ± 1° typ. 0.8 f_c - 1.0 f_c ± 3° max. ± 1.5° typ.	0 - 0.8 f_c ± 2° max. ± 1° typ. 0.8 f_c - 1.0 f_c ± 3° max. ± 1.5° typ.
Amplitude Accuracy (theoretical)	0 - 0.8 f_c ± 0.2 dB max. ± 0.1 dB typ. 0.8 f_c - 1.0 f_c ± 0.3 dB max. ± 0.15 dB typ.	0 - f_c ± 0.2 dB max. ± 0.1 dB typ.	0 - 0.8 f_c ± 0.2 dB max. ± 0.1 dB typ. 0.8 f_c - 1.0 f_c ± 0.3 dB max. ± 0.15 dB typ.	0 - 0.8 f_c ± 0.2 dB max. ± 0.1 dB typ. 0.8 f_c - 1.0 f_c ± 0.3 dB max. ± 0.15 dB typ.
Total Harmonic Distortion @ 1 kHz	< - 100 dB typ.	< - 100 dB typ.	< - 88 dB typ.	< - 88 dB typ.
Wide Band Noise (5 Hz - 2 MHz)	200 μ Vrms typ.	200 μ Vrms typ.	200 μ Vrms typ.	200 μ Vrms typ.
Narrow Band Noise (5 Hz - 100 kHz)	50 μ Vrms typ.	50 μ Vrms typ.	50 μ Vrms typ.	50 μ Vrms typ.
Filter Mounting Assembly	FMA-02A	FMA-02A	FMA-02A	FMA-02A

1. Unit to unit match for the same transfer function, set to the same frequency and operating configuration, and from the same manufacturing lot.



4-Pole High-Pass Filters

4-Bit Programmable

Model	424H4B	424H4Y2	424H4Y5	
Product Specifications				
Transfer Function	4-Pole, Butterworth	4-Pole, Chebychev, 0.2 dB Ripple	4-Pole, Chebychev, 0.5 dB Ripple	
Size	0.8" x 1.8" x 0.3"	0.8" x 1.8" x 0.3"	0.8" x 1.8" x 0.3"	
Range f_c	10.0 Hz to 102.4 kHz	10.0 Hz to 102.4 kHz	10.0 Hz to 102.4 kHz	
Theoretical Transfer Characteristics	Appendix A Page 27	Appendix A Page 31	Appendix A Page 33	
Passband Ripple (theoretical)	0.0 dB	0.20 dB	0.50 dB	
Voltage Gain (non-inverting)	0 ± 0.2 dB to 100 kHz 0 ± 0.5 dB to 120 kHz	0 ± 0.2 dB to 100 kHz 0 ± 0.5 dB to 120 kHz	0 ± 0.2 dB to 100 kHz 0 ± 0.5 dB to 120 kHz	
Power Bandwidth	120 kHz	120 kHz	120 kHz	
Small Signal Bandwidth	(-6 dB) 1 MHz	(-6 dB) 1 MHz	(-6 dB) 1 MHz	
Stopband Attenuation Rate	24 dB/octave	24 dB/octave	24 dB/octave	
Cutoff Frequency Stability Amplitude Phase	f_c ± 2% max. ± 0.01% /°C -3 dB 180°	f_c ± 2% max. ± 0.01% /°C -3 dB 231°	f_c ± 2% max. ± 0.01% /°C -3 dB 245°	
Filter Attenuation (theoretical)	40 dB 0.31 f_c 30 dB 0.42 f_c 3.01 dB 1.00 f_c 0.02 dB 2.00 f_c	40.0 dB 0.41 f_c 30.0 dB 0.53 f_c 3.01 dB 1.00 f_c -0.07 dB 2.00 f_c	40.0 dB 0.43 f_c 30.0 dB 0.56 f_c 3.01 dB 1.00 f_c -0.25 dB 2.00 f_c	
Phase Match¹	f_c - 100 kHz ± 3° max. ± 1.5° typ.	f_c - 100 kHz ± 3° max. ± 1.5° typ.	f_c - 100 kHz ± 3° max. ± 1.5° typ.	
Amplitude Accuracy (theoretical)	1.0 - 1.25 f_c ± 0.3 dB max. ± 0.15 dB typ. 1.25 f_c - 100 kHz ± 0.2 dB max. ± 0.1 dB max.	1.0 - 1.25 f_c ± 0.3 dB max. ± 0.15 dB typ. 1.25 f_c - 100 kHz ± 0.2 dB max. ± 0.1 dB typ.	1.0 - 1.25 f_c ± 0.3 dB max. ± 0.15 dB typ. 1.25 f_c - 100 kHz ± 0.2 dB max. ± 0.1 dB typ.	
Total Harmonic Distortion @ 1kHz	< - 100 dB typ.	< - 88 dB typ.	< - 88 dB typ.	
Wide Band Noise (5 Hz - 2 MHz)	400 μ Vrms typ.	400 μ Vrms typ.	400 μ Vrms typ.	
Narrow Band Noise (5 Hz - 100 kHz)	100 μ Vrms typ.	100 μ Vrms typ.	100 μ Vrms typ.	
Filter Mounting Assembly	FMA-02A	FMA-02A	FMA-02A	

1. Unit to unit match for the same transfer function, set to the same frequency and operating configuration, and from the same manufacturing lot.



424 Series

Specification

(25°C and $V_s \pm 15$ Vdc)

Pin-Out and Package Data Ordering Information

Analog Input Characteristics¹

Impedance	10 k Ω min.
Voltage Range	± 10 Vpeak
Max. Safe Voltage	$\pm V_s$

Analog Output Characteristics

Impedance (Closed Loop)	1 Ω typ. 10 Ω max.
Linear Operating Range	± 10 V
Maximum Current ²	± 2 mA
Offset Voltage ³	2 mV typ. 20 mV max.

Offset Temp. Coeff. 50 nV/°C

Power Supply ($\pm V$)

Rated Voltage	± 15 Vdc
Operating Range	± 12 to ± 18 Vdc
Maximum Safe Voltage	± 18 Vdc
Quiescent Current	
4-Pole	± 13 mA typ. ± 20 mA max.

Temperature

Operating	0 to +70°C
Storage	-25 to +85°C

Notes:

- Input and output signal voltage referenced to supply common.
- Output is short circuit protected to common.
DO NOT CONNECT TO $\pm V_s$.
- Adjustable to zero.
- Units operate with or without offset pin connected.

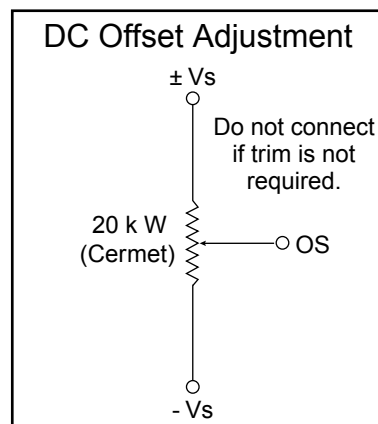

424 Package OUTLINE

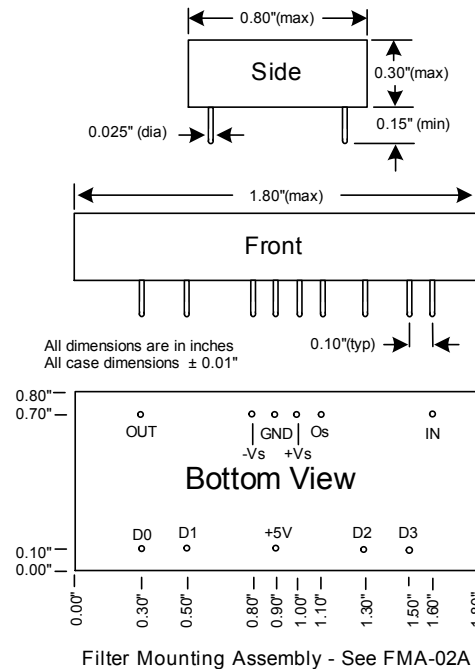

Ordering Information

Filter Type	424 Transfer Function
L - Low Pass	B - Butterworth
H - High Pass	L - Bessel
	Y2 - 0.2 Ripple Chebychev
	Y5 - 0.5 Ripple Chebychev

424 L4L-7

Model Number

Binary Tuning Ranges		
Model Number	Tuning Range (Hz)	*Minimum Step (Hz)
1	10-160	10
2	25-400	25
3	50-800	50
4	100-1.60k	100
5	250-4.00k	250
6	500-8.00k	500
7	1.00k-16.0k	1.00k
8	2.50k-40.0k	2.50k
9	5.00k-80.0k	5.00k
10	6.40k-102.4k	6.40k

*Contact factory for custom step frequency. Maximum step 6.40 kHz.

Discrete Frequency's

Customer must specify f_1, f_2, f_3, f_4, f_5 . Maximum span $f_1 \rightarrow f_5$ 1,000:1.

We hope the information given here will be helpful. The information is based on data and our best knowledge, and we consider the information to be true and accurate. Please read all statements, recommendations or suggestions herein in conjunction with our conditions of sale which apply to all goods supplied by us. We assume no responsibility for the use of these statements, recommendations or suggestions, nor do we intend them as a recommendation for any use which would infringe any patent or copyright. IN-00424-02



Appendix A

Theoretical Transfer Characteristics

f/fc (Hz)	Amp (dB)	Phase (deg)	Delay ¹ (sec)
0.00	0.00	0.00	.336
0.10	-0.028	-12.1	.336
0.20	-0.111	-24.2	.336
0.30	-0.251	-36.3	.336
0.40	-0.448	-48.4	.336
0.50	-0.705	-60.6	.336
0.60	-1.02	-72.7	.336
0.70	-1.41	-84.8	.336
0.80	-1.86	-96.8	.335
0.85	-2.11	-103	.334
0.90	-2.40	-109	.333
0.95	-2.69	-115	.332
1.00	-3.01	-121	.330
1.10	-3.71	-133	.325
1.20	-4.51	-144	.318
1.30	-5.39	-156	.308
1.40	-6.37	-166	.295
1.50	-7.42	-177	.280
1.60	-8.54	-187	.263
1.70	-9.71	-195	.246
1.80	-10.9	-204	.228
1.90	-12.2	-212	.211
2.00	-13.4	-219	.194
2.25	-16.5	-235	.158
2.50	-19.5	-248	.129
2.75	-22.4	-259	.107
3.00	-25.1	-267	.089
3.25	-27.6	-275	.076
3.50	-30.0	-281	.065
4.00	-34.4	-291	.049
5.00	-41.9	-305	.031
6.00	-48.1	-315	.021
7.00	-53.4	-321	.016
8.00	-58.0	-326	.012
9.00	-62.0	-330	.009
10.0	-65.7	-333	.008

Frequency Response

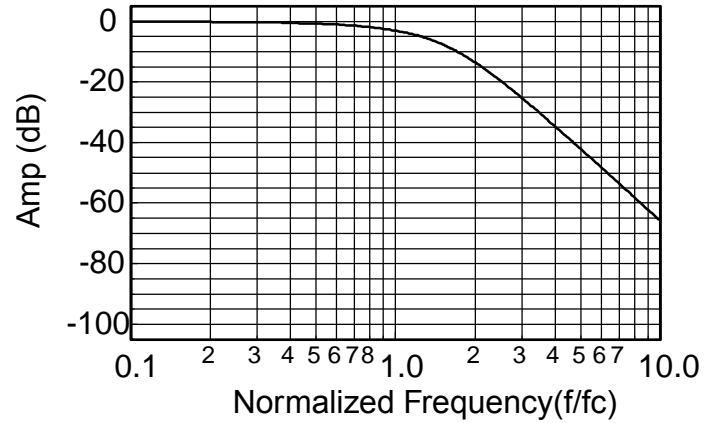

Delay (Normalized)

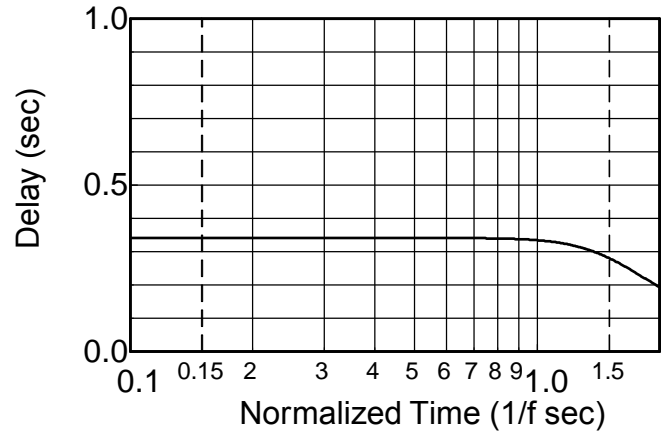

Step Response

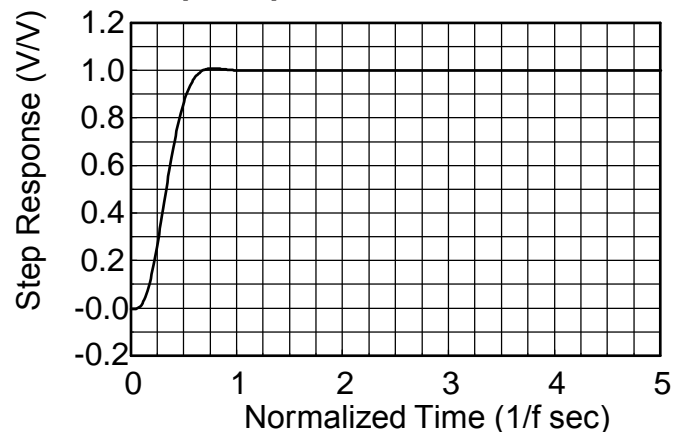

1. Normalized Group Delay:

The above delay data is normalized to a corner frequency of 1.0Hz. The actual delay is the normalized delay divided by the actual corner frequency (fc).

$$\text{Actual Delay} = \frac{\text{Normalized Delay}}{\text{Actual Corner Frequency (fc) in Hz}}$$



Appendix A

Theoretical Transfer Characteristics

f/fc (Hz)	Amp (dB)	Phase (deg)	Delay ¹ (sec)
0.00	0.00	0.00	.416
0.10	0.00	-15.0	.418
0.20	0.00	-30.1	.423
0.30	-0.00	-45.5	.433
0.40	-0.003	-61.4	.449
0.50	-0.017	-78.0	.474
0.60	-0.072	-95.7	.511
0.70	-0.243	-115	.558
0.80	-0.674	-136	.604
0.85	-1.047	-147	.619
0.90	-1.555	-158	.622
0.95	-2.21	-169	.612
1.00	-3.01	-180	.588
1.10	-4.97	-200	.513
1.20	-7.24	-217	.427
1.30	-9.62	-231	.350
1.40	-12.0	-242	.289
1.50	-14.3	-252	.241
1.60	-16.4	-260	.204
1.70	-18.5	-266	.175
1.80	-20.5	-272	.152
1.90	-22.3	-277	.134
2.00	-24.1	-282	.119
2.25	-28.2	-291	.091
2.50	-31.8	-299	.072
2.75	-35.1	-304	.059
3.00	-38.2	-309	.049
3.25	-41.0	-313	.041
3.50	-43.5	-317	.035
4.00	-48.2	-322	.027
5.00	-55.9	-330	.017
6.00	-62.3	-335	.012
7.00	-67.6	-339	.009
8.00	-72.2	-341	.007
9.00	-76.3	-343	.005
10.0	-80.0	-345	.004

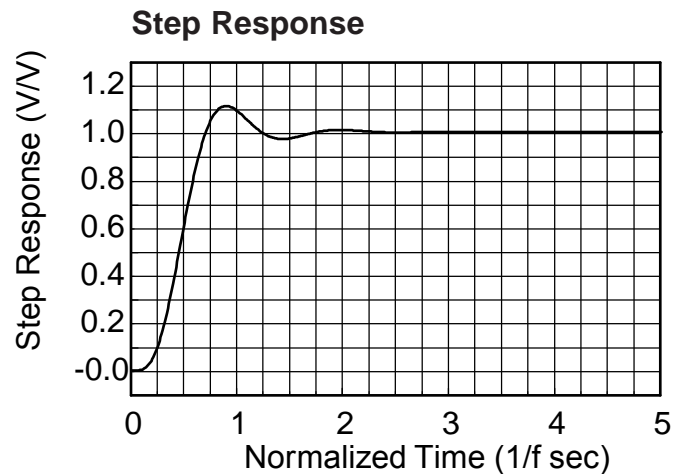
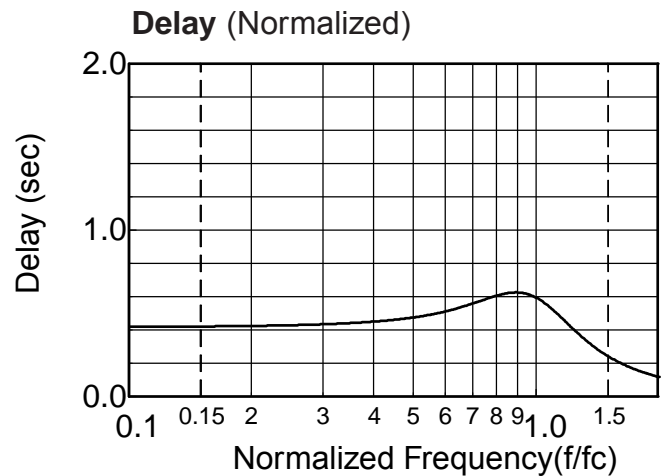
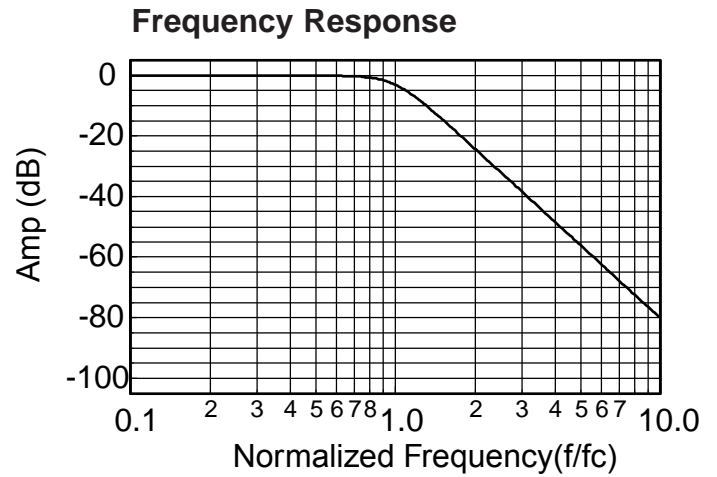

1. Normalized Group Delay:

The above delay data is normalized to a corner frequency of 1.0Hz. The actual delay is the normalized delay divided by the actual corner frequency (fc).

$$\text{Actual Delay} = \frac{\text{Normalized Delay}}{\text{Actual Corner Frequency (fc) in Hz}}$$



Appendix A

Theoretical Transfer Characteristics

f/fc (Hz)	Amp (dB)	Phase (deg)	Delay ¹ (sec)
0.00	0.000	0.00	.478
0.10	0.039	-17.3	.487
0.20	0.129	-35.2	.509
0.30	0.195	-54.0	.533
0.40	0.174	-73.4	.547
0.50	0.074	-93.2	.553
0.60	0.000	-113	.575
0.70	0.074	-135	.654
0.80	0.199	-162	.836
0.85	0.063	-178	.947
0.90	-0.443	-196	1.02
0.95	-1.47	-214	.989
1.00	-3.01	-231	.873
1.10	-6.89	-257	.583
1.20	-10.8	-274	.385
1.30	-14.5	-286	.271
1.40	-17.7	-294	.202
1.50	-20.7	-300	.158
1.60	-23.4	-306	.128
1.70	-25.8	-310	.107
1.80	-28.1	-313	.090
1.90	-30.2	-316	.078
2.00	-32.2	-319	.068
2.25	-36.7	-324	.051
2.50	-40.6	-328	.039
2.75	-44.1	-331	.032
3.00	-47.3	-334	.026
3.25	-50.2	-336	.022
3.50	-52.8	-338	.018
4.00	-57.6	-341	.014
5.00	-65.5	-345	.009
6.00	-71.9	-347	.006
7.00	-77.3	-349	.004
8.00	-82.0	-351	.003
9.00	-86.1	-352	.003
10.0	-89.8	-352	.002

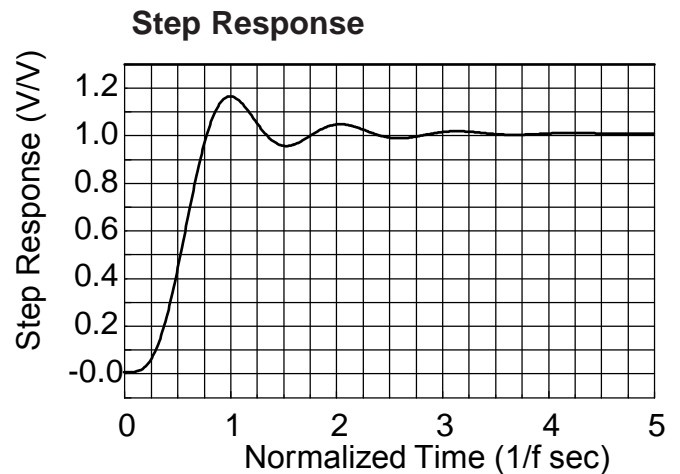
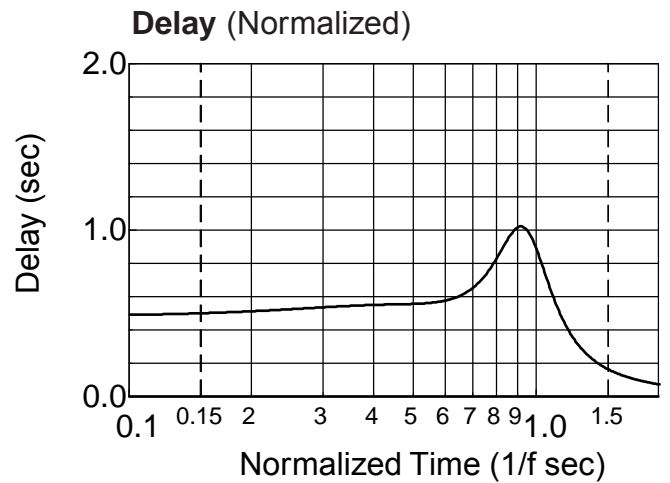
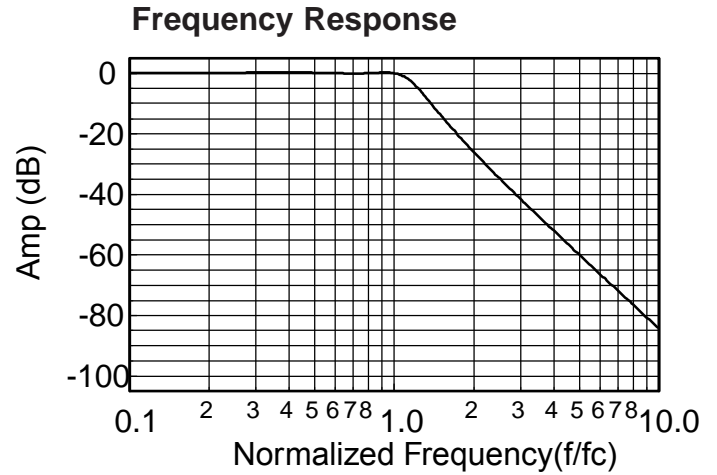

1. Normalized Group Delay:

The above delay data is normalized to a corner frequency of 1.0Hz. The actual delay is the normalized delay divided by the actual corner frequency (fc).

$$\text{Actual Delay} = \frac{\text{Normalized Delay}}{\text{Actual Corner Frequency (fc) in Hz}}$$



Appendix A

Theoretical Transfer Characteristics

f/fc (Hz)	Amp (dB)	Phase (deg)	Delay ¹ (sec)
0.00	0.00	0.00	.476
0.10	0.087	-17.3	.492
0.20	0.295	-35.7	.533
0.30	0.474	-55.7	.577
0.40	0.463	-76.9	.596
0.50	0.248	-98.2	.583
0.60	0.025	-119	.578
0.70	0.072	-141	.647
0.80	0.432	-168	.881
0.85	0.482	-185	1.06
0.90	0.062	-205	1.18
0.95	-1.12	-226	1.13
1.00	-3.01	-245	.946
1.10	-7.61	-272	.559
1.20	-12.0	-288	.345
1.30	-15.9	-298	.235
1.40	-19.3	-305	.173
1.50	-22.4	-311	.134
1.60	-25.1	-315	.108
1.70	-27.6	-318	.089
1.80	-29.9	-321	.075
1.90	-32.1	-324	.065
2.00	-34.1	-326	.057
2.25	-38.6	-301	.042
2.50	-42.6	-334	.033
2.75	-46.1	-336	.026
3.00	-49.3	-339	.021
3.25	-52.2	-340	.018
3.50	-54.9	-342	.015
4.00	-59.7	-344	.011
5.00	-67.6	-347	.007
6.00	-74.0	-350	.005
7.00	-79.4	-351	.004
8.00	-84.1	-352	.003
9.00	-88.2	-353	.002
10.0	-91.9	-354	.002

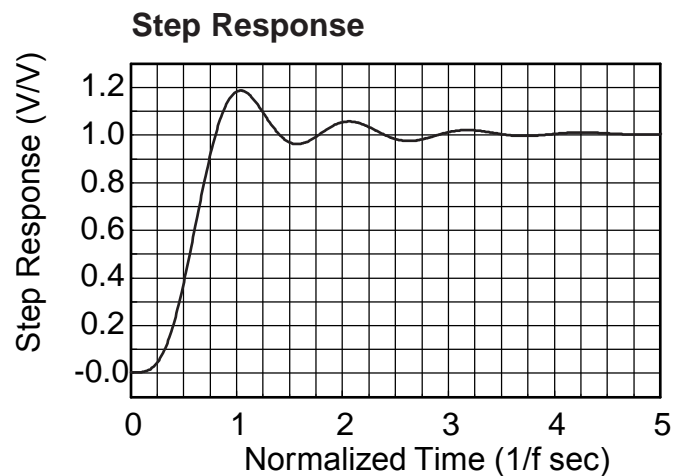
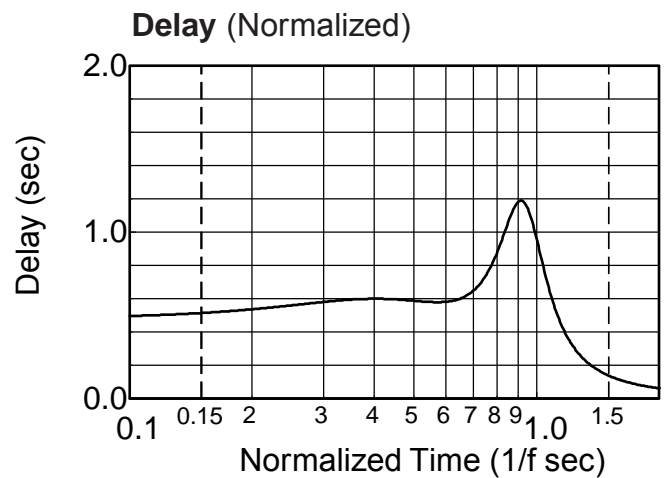
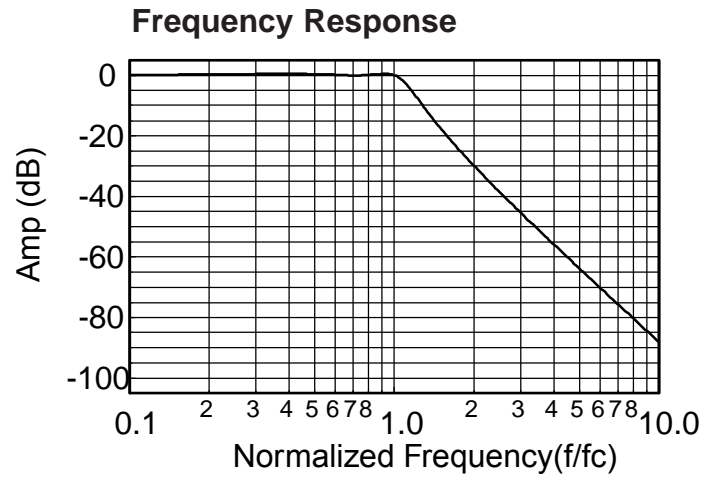

1. Normalized Group Delay:

The above delay data is normalized to a corner frequency of 1.0Hz. The actual delay is the normalized delay divided by the actual corner frequency (fc).

$$\text{Actual Delay} = \frac{\text{Normalized Delay}}{\text{Actual Corner Frequency (fc) in Hz}}$$



Theoretical Transfer Characteristics

f/fc (Hz)	Amp (dB)	Phase (deg)	Delay ¹ (sec)
0.10	-80.0	345	.418
0.20	-55.9	330	.423
0.30	-41.8	314	.433
0.40	-31.8	299	.449
0.50	-24.1	282	.474
0.60	-17.8	264	.511
0.70	-12.6	245	.558
0.80	-8.43	224	.604
0.85	-6.69	213	.619
0.90	-5.22	202	.622
0.95	-3.99	191	.612
1.00	-3.01	180	.588
1.20	-0.908	143	.427
1.40	-0.285	118	.289
1.60	-0.100	100	.204
1.80	-0.039	87.6	.152
2.00	-0.017	78.0	.119
2.50	-0.003	61.4	.072
3.00	-0.001	50.7	.049
4.00	0.00	37.8	.027
5.00	0.00	30.1	.017
6.00	0.00	25.1	.012
7.00	0.00	21.4	.009
8.00	0.00	18.8	.007
9.00	0.00	16.7	.005
10.0	0.00	15.0	.004

Frequency Response

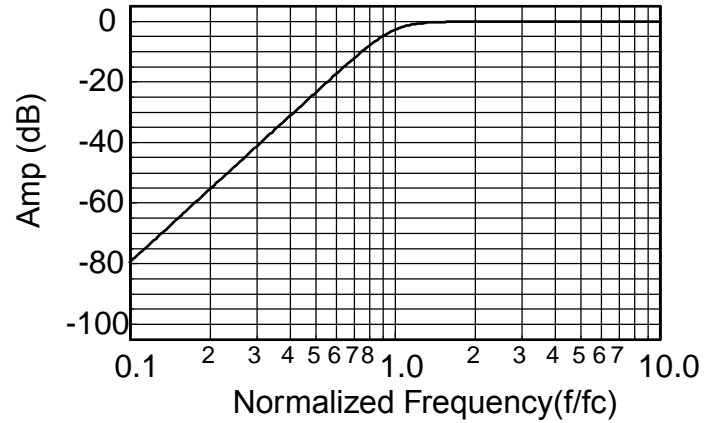

1. Normalized Group Delay:

The above delay data is normalized to a corner frequency of 1.0Hz. The actual delay is the normalized delay divided by the actual corner frequency (fc).

$$\text{Actual Delay} = \frac{\text{Normalized Delay}}{\text{Actual Corner Frequency (fc) in Hz}}$$



Appendix A

Theoretical Transfer Characteristics

f/fc (Hz)	Amp (dB)	Phase (deg)	Delay ¹ (sec)
0.10	-89.8	352	.212
0.20	-65.1	345	.218
0.30	-51.1	337	.228
0.40	-40.6	328	.245
0.50	-32.2	319	.272
0.60	-25.0	308	.314
0.70	-18.6	296	.383
0.80	-12.7	280	.500
0.90	-7.34	259	.686
1.00	-3.01	231	.873
1.20	.140	172	.633
1.50	.031	128	.275
1.70	.003	111	.197
2.00	.074	93.2	.138
2.50	.174	73.4	.088
3.00	.200	60.4	.060
4.00	.170	44.5	.033
5.00	.129	35.2	.020
6.00	.098	29.2	.014
7.00	.076	24.9	.010
8.00	.060	21.7	.008
9.00	.048	19.3	.006
10.0	.040	17.3	.005

Frequency Response

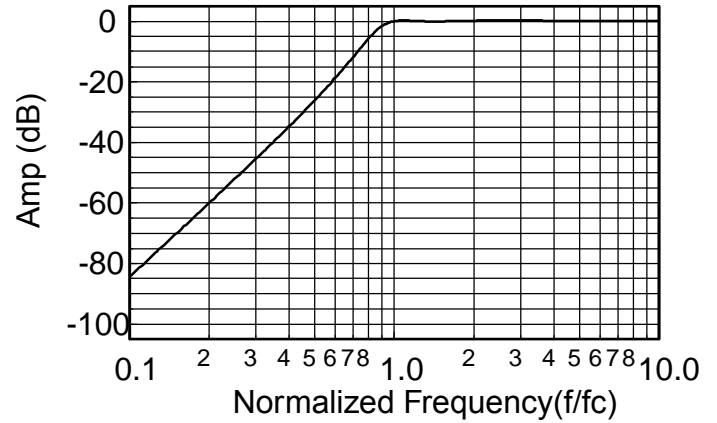

1. Normalized Group Delay:

The above delay data is normalized to a corner frequency of 1.0Hz. The actual delay is the normalized delay divided by the actual corner frequency (fc).

$$\text{Actual Delay} = \frac{\text{Normalized Delay}}{\text{Actual Corner Frequency (fc) in Hz}}$$



Appendix A

Theoretical Transfer Characteristics

f/fc (Hz)	Amp (dB)	Phase (deg)	Delay ¹ (sec)
0.10	-91.9	354	.174
0.20	-67.6	347	.179
0.30	-53.1	341	.188
0.40	-42.6	334	.203
0.50	-34.1	326	.226
0.60	-26.8	317	.263
0.70	-20.2	307	.326
0.80	-14.0	293	.440
0.90	-8.13	274	.651
1.00	-3.01	245	.946
1.20	.500	179	.693
1.50	.014	133	.271
1.70	.043	117	.199
2.00	.249	98.2	.146
2.50	.469	76.9	.095
3.00	.498	62.7	.065
4.00	.401	45.5	.035
5.00	.296	35.7	.021
6.00	.221	29.4	.014
7.00	.169	25.0	.010
8.00	.133	21.8	.008
9.00	.107	19.3	.006
10.0	.088	17.3	.005

Frequency Response

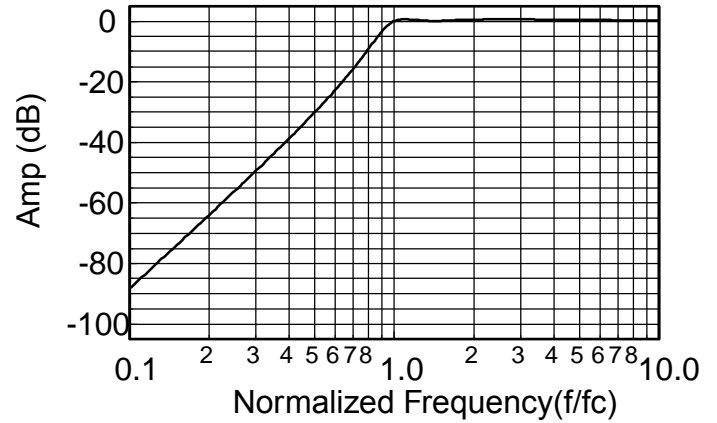

1. Normalized Group Delay:

The above delay data is normalized to a corner frequency of 1.0Hz. The actual delay is the normalized delay divided by the actual corner frequency (fc).

$$\text{Actual Delay} = \frac{\text{Normalized Delay}}{\text{Actual Corner Frequency (fc) in Hz}}$$