

54F/74F821 10-Bit D-Type Flip-Flop

General Description

The 'F821 is a 10-bit D-type flip-flop with TRI-STATE® true outputs arranged in a broadside pinout. The 'F821 is functionally and pin compatible with the AMD's Am29821.

Features

- TRI-STATE Outputs
- Direct replacement for AMD's Am29821

Commercial	Military	Package Number	Package Description
74F821SPC		N24C	24-Lead (0.300" Wide) Molded Dual-In-Line
	54F821SDM (Note 2)	J24F	24-Lead (0.300" Wide) Ceramic Dual-In-Line
74F821SC (Note 1)		M24B	24-Lead (0.300" Wide) Molded Small Outline, JEDEC
	54F821FM (Note 2)	W24C	24-Lead Cerpack
	54F821LM (Note 2)	E28A	24-Lead Ceramic Leadless Chip Carrier, Type C

Note 1: Devices also available in 13" reel. Use suffix = SCX.

Note 2: Military grade device with environmental and burn-in processing. Use suffix = SDMQB, FMQB and LMQB.

Logic Symbols

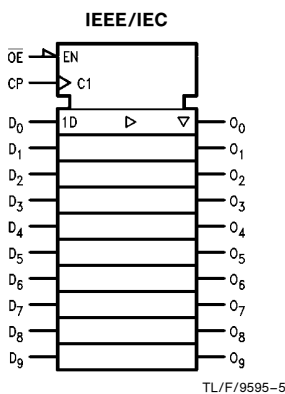
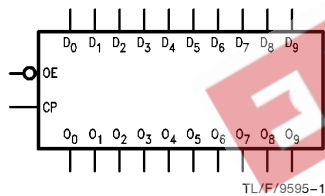

Pin Assignment for DIP, SOIC and Flatpak

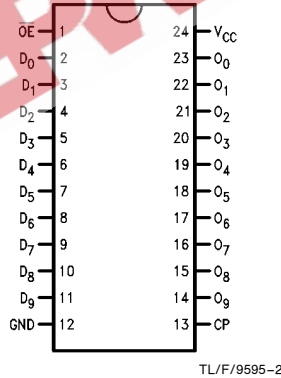

Connection Diagrams

Pin Assignment for LCC

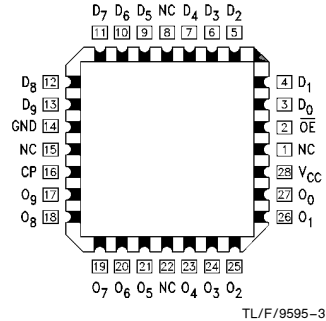

TRI-STATE® is a registered trademark of National Semiconductor Corporation.

Unit Loading/Fan Out

Pin Names	Description	54F/74F	
		U.L. HIGH/LOW	Input I_{IH}/I_{IL} Output I_{OH}/I_{OL}
D_0-D_9	Data Inputs	1.0/1.0	20 μ A/ -0.6 mA
\overline{OE}	Output Enable	1.0/1.0	20 μ A/ -0.6 mA
CP	TRI-STATE Input	1.0/1.0	20 μ A/ -0.6 mA
O_0-O_9	TRI-STATE Outputs	150/40 (33.3)	-3.0 mA/24 mA (20 mA)

Functional Description

The 'F821 consists of ten D-type edge-triggered flip-flops. This device has TRI-STATE true outputs for bus systems organized in a broadside pinning. The buffered Clock (CP) and buffered Output Enable (\overline{OE}) are common to all flip-flops. The flip-flops will store the state of their individual D inputs that meet the setup and hold times requirements on the LOW-to-HIGH CP transition. With the \overline{OE} LOW the content of the flip-flops are available at the outputs. When the \overline{OE} is HIGH, the outputs go to the high impedance state. Operation of the \overline{OE} input does not affect the state of the flip-flops.

Function Table

Inputs			Internal	Output	Function
\overline{OE}	CP	D	\overline{Q}	O	
H	H	X	NC	Z	Hold
H	L	X	NC	Z	Hold
H	\nearrow	L	H	Z	Load
H	\nearrow	H	L	Z	Load
L	\nearrow	L	H	L	Data Available
L	\nearrow	H	L	H	Data Available
L	H	X	NC	NC	No Change in Data
L	L	X	NC	NC	No Change in Data

L = LOW Voltage Level
H = HIGH Voltage Level
X = Immaterial
Z = High Impedance
 \nearrow = LOW-to-HIGH Transition
NC = No Change

Logic Diagram

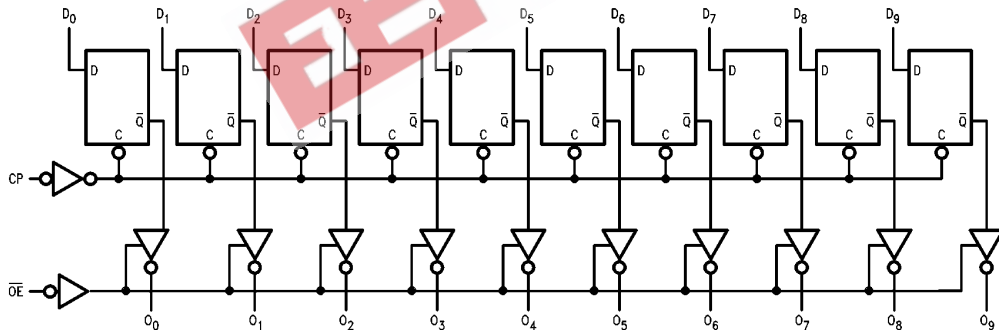

TL/F/9595-4

Please note that this diagram is provided only for the understanding of logic operations and should not be used to estimate propagation delays.

Absolute Maximum Ratings (Note 1)

If Military/Aerospace specified devices are required, please contact the National Semiconductor Sales Office/Distributors for availability and specifications.

Storage Temperature	-65°C to +150°C
Ambient Temperature under Bias	-55°C to +125°C
Junction Temperature under Bias	-55°C to +175°C
Plastic	-55°C to +150°C
V _{CC} Pin Potential to Ground Pin	-0.5V to +7.0V
Input Voltage (Note 2)	-0.5V to +7.0V
Input Current (Note 2)	-30 mA to +5.0 mA
Voltage Applied to Output in HIGH State (with V _{CC} = 0V)	
Standard Output	-0.5V to V _{CC}
TRI-STATE Output	-0.5V to +5.5V

Current Applied to Output in LOW State (Max) twice the rated I_{OL} (mA)

Note 1: Absolute maximum ratings are values beyond which the device may be damaged or have its useful life impaired. Functional operation under these conditions is not implied.

Note 2: Either voltage limit or current limit is sufficient to protect inputs.

Recommended Operating Conditions

Free Air Ambient Temperature	
Military	-55°C to +125°C
Commercial	0°C to +70°C
Supply Voltage	
Military	+4.5V to +5.5V
Commercial	+4.5V to +5.5V

DC Electrical Characteristics

Symbol	Parameter	54F/74F			Units	V _{CC}	Conditions
		Min	Typ	Max			
V _{IH}	Input HIGH Voltage	2.0			V		Recognized as a HIGH Signal
V _{IL}	Input LOW Voltage			0.8	V		Recognized as a LOW Signal
V _{CD}	Input Clamp Diode Voltage			-1.2	V	Min	I _{IN} = -18 mA
V _{OH}	Output HIGH Voltage	54F 10% V _{CC} 54F 10% V _{CC} 74F 10% V _{CC} 74F 10% V _{CC} 74F 5% V _{CC} 74F 5% V _{CC}	2.5 2.4 2.5 2.4 2.7 2.7		V	Min	I _{OH} = -1 mA I _{OH} = -3 mA I _{OH} = -1 mA I _{OH} = -3 mA I _{OH} = -1 mA I _{OH} = -3 mA
V _{OL}	Output LOW Voltage	54F 10% V _{CC} 74F 10% V _{CC}		0.5 0.5	V	Min	I _{OL} = 20 mA I _{OL} = 24 mA
I _{IH}	Input HIGH Current	54F 74F		20.0 5.0	μA	Max	V _{IN} = 2.7V
I _{BVI}	Input HIGH Current Breakdown Test	54F 74F		100 7.0	μA	Max	V _{IN} = 7.0V
I _{CEX}	Output HIGH Leakage Current	54F 74F		250 50	μA	Max	V _{OUT} = V _{CC}
V _{ID}	Input Leakage Test	74F	4.75		V	0.0	I _{ID} = 1.9 μA, All Other Pins Grounded
I _{OD}	Output Leakage Circuit Current	74F		3.75	μA	0.0	V _{IOD} = 150 mV All Other Pins Grounded
I _{IL}	Input LOW Current			-0.6	mA	Max	V _{IN} = 0.5V
I _{OZH}	Output Leakage Current			50	μA	Max	V _{OUT} = 2.7V
I _{OZL}	Output Leakage Current			-50	μA	Max	V _{OUT} = 0.5V
I _{OS}	Output Short-Circuit Current			-60	mA	Max	V _{OUT} = 0V
I _{CCZ}	Power Supply Current		78	100	mA	Max	V _O = HIGH Z

AC Electrical Characteristics

Symbol	Parameter	74F			54F		74F		Units
		T _A = +25°C V _{CC} = +5.0V C _L = 50 pF			T _A , V _{CC} = Mil C _L = 50 pF		T _A , V _{CC} = Com C _L = 50 pF		
		Min	Typ	Max	Min	Max	Min	Max	
f _{max}	Maximum Clock Frequency	100	150		60	10.5	70		MHz
t _{PLH}	Propagation Delay	2.0	6.4	9.5	2.0	10.5	2.0	10.5	ns
t _{PHL}	CP to O _n	2.0	6.2	9.5	2.0	10.5	2.0	10.5	
t _{pZH}	Output Enable Time	2.0	5.8	10.5	2.0	13.0	2.0	11.5	ns
t _{pZL}	\overline{OE} to O _n	2.0	6.3	10.5	2.0	13.0	2.0	11.5	
t _{PHZ}	Output Disable Time	1.5	3.4	7.0	1.0	7.5	1.5	7.5	ns
t _{PLZ}	\overline{OE} to O _n	1.5	3.5	7.0	1.0	7.5	1.5	7.5	

AC Operating Requirements

Symbol	Parameter	74F		54F		74F		Units
		T _A = +25°C V _{CC} = +5.0V		T _A , V _{CC} = Mil		T _A , V _{CC} = Com		
		Min	Max	Min	Max	Min	Max	
t _s (H)	Setup Time, HIGH or LOW	2.5		4.0		3.0		ns
t _s (L)	D _n to CP	2.5		4.0		3.0		
t _h (H)	Hold Time, HIGH or LOW	2.5		2.5		2.5		ns
t _h (L)	D _n to CP	2.5		2.5		2.5		
t _w (H)	CP Pulse Width	5.0		6.0		6.0		ns
t _w (L)	HIGH or LOW	5.0		6.0		6.0		

Ordering Information

The device number is used to form part of a simplified purchasing code where the package type and temperature range are defined as follows:

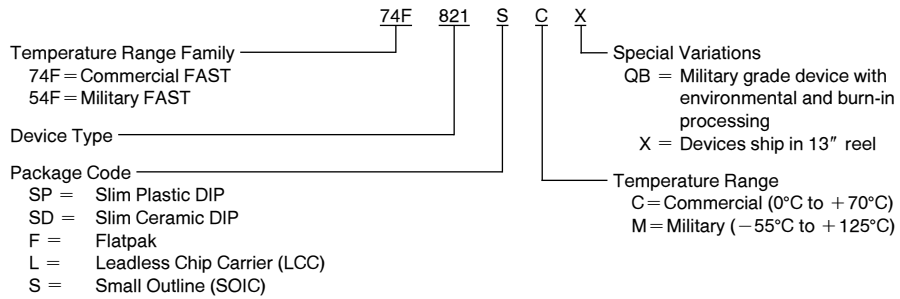

EEPW 电子產品世界
.com.cn

Physical Dimensions inches (millimeters) (Continued)

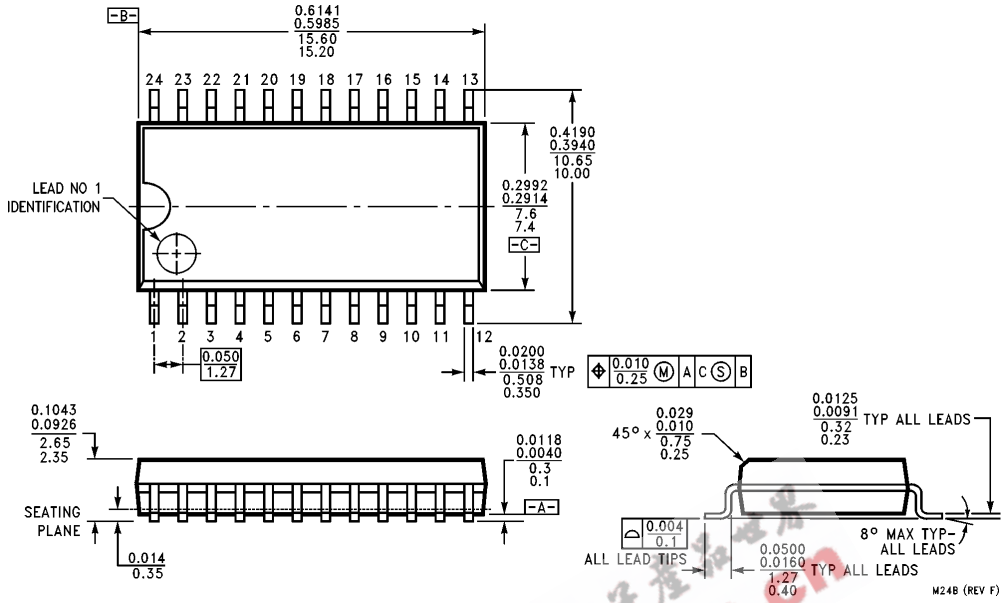

**24-Lead (0.300" Wide) Molded Small Outline Package, JEDEC (S)
NS Package Number M24B**

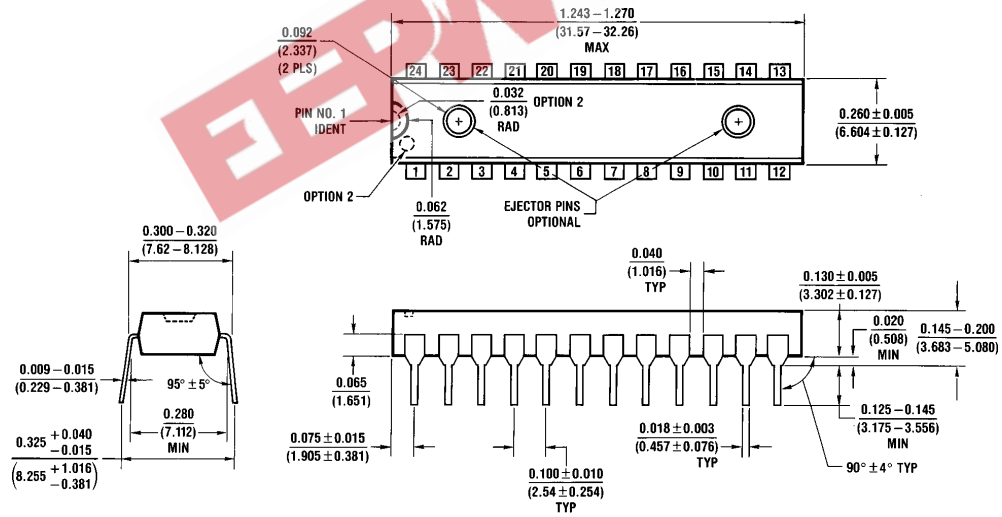

**24-Lead (0.300" Wide) Molded Dual-In-Line Package (SP)
NS Package Number N24C**

Physical Dimensions inches (millimeters) (Continued)

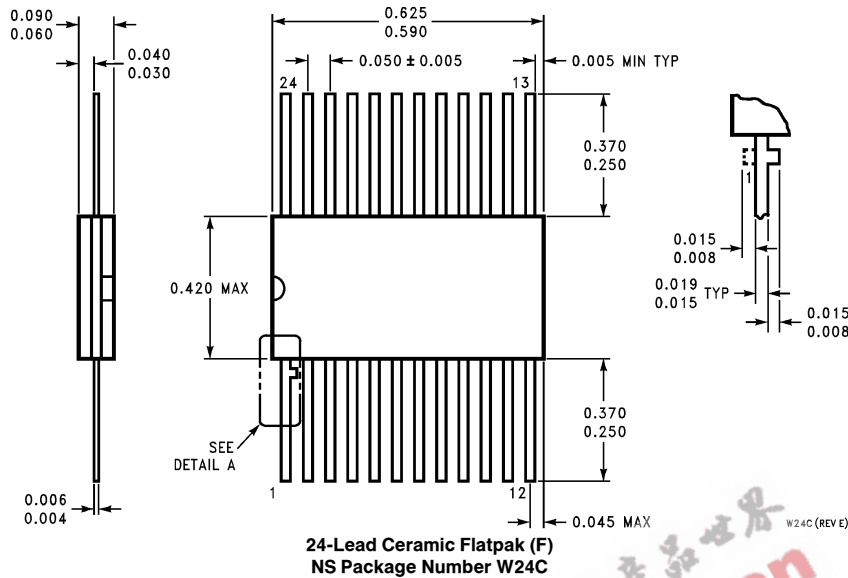

EEPW.com.cn 电子产品世界

LIFE SUPPORT POLICY

NATIONAL'S PRODUCTS ARE NOT AUTHORIZED FOR USE AS CRITICAL COMPONENTS IN LIFE SUPPORT DEVICES OR SYSTEMS WITHOUT THE EXPRESS WRITTEN APPROVAL OF THE PRESIDENT OF NATIONAL SEMICONDUCTOR CORPORATION. As used herein:

1. Life support devices or systems are devices or systems which, (a) are intended for surgical implant into the body, or (b) support or sustain life, and whose failure to perform, when properly used in accordance with instructions for use provided in the labeling, can be reasonably expected to result in a significant injury to the user.
2. A critical component is any component of a life support device or system whose failure to perform can be reasonably expected to cause the failure of the life support device or system, or to affect its safety or effectiveness.

 <p>National Semiconductor Corporation 2900 Semiconductor Drive P.O. Box 58090 Santa Clara, CA 95052-8090 Tel: 1 (800) 272-9959 TWX: (910) 339-9240</p>	<p>National Semiconductor GmbH Livry-Gargan-Str. 10 D-82256 Fürstenfeldbruck Germany Tel: (81-41) 35-0 Telex: 527649 Fax: (81-41) 35-1</p>	<p>National Semiconductor Japan Ltd. Sumitomo Chemical Engineering Center Bldg. 7F 1-7-1, Nakase, Mihama-Ku Chiba-City, Chiba Prefecture 261 Tel: (043) 299-2300 Fax: (043) 299-2500</p>	<p>National Semiconductor Hong Kong Ltd. 13th Floor, Straight Block, Ocean Centre, 5 Canton Rd. Tsimshatsui, Kowloon Hong Kong Tel: (852) 2737-1600 Fax: (852) 2736-9960</p>	<p>National Semiconductores Do Brazil Ltda. Rue Deputado Lacorda Franco 120-3A Sao Paulo-SP Brazil 05418-000 Tel: (55-11) 212-5066 Telex: 391-1131931 NSBR BR Fax: (55-11) 212-1181</p>	<p>National Semiconductor (Australia) Pty, Ltd. Building 16 Business Park Drive Monash Business Park Nottingham, Melbourne Victoria 3168 Australia Tel: (3) 558-9889 Fax: (3) 558-9898</p>
--	---	---	---	---	--

National does not assume any responsibility for use of any circuitry described, no circuit patent licenses are implied and National reserves the right at any time without notice to change said circuitry and specifications.