

# DATA SHEET

EEPW 电子产品世界  
.com.cn

## **74LVC2G17**

Dual non-inverting Schmitt-trigger  
with 5 V tolerant input

Product specification

2003 Aug 13

## Dual non-inverting Schmitt-trigger with 5 V tolerant input

## 74LVC2G17

### FEATURES

- Wide supply voltage range from 1.65 to 5.5 V
- 5 V tolerant input/output for interfacing with 5 V logic
- High noise immunity
- Complies with JEDEC standard:
  - JESD8-7 (1.65 to 1.95 V)
  - JESD8-5 (2.3 to 2.7 V)
  - JESD8B/JESD36 (2.7 to 3.6 V).
- ESD protection:
  - HBM EIA/JESD22-A114-A exceeds 2000 V
  - MM EIA/JESD22-A115-A exceeds 200 V.
- $\pm 24$  mA output drive ( $V_{CC} = 3.0$  V)
- CMOS low power consumption
- Latch-up performance exceeds 250 mA
- Direct interface with TTL levels
- SOT363 and SOT457 package
- Specified from  $-40$  to  $+125$  °C.

### APPLICATIONS

- Wave and pulse shapers for highly noisy environments.

### DESCRIPTION

The 74LVC2G17 is a high-performance, low-power, low-voltage, Si-gate CMOS device and superior to most advanced CMOS compatible TTL families.

Inputs can be driven from either 3.3 or 5 V devices. These feature allows the use of these devices as translators in a mixed 3.3 and 5 V environment.

This device is fully specified for partial power-down applications using  $I_{off}$ . The  $I_{off}$  circuitry disables the output, preventing the damaging back flow current through the device when it is powered down.

The 74LVC2G17 provides two non-inverting buffers with Schmitt-trigger action. It is capable of transforming slowly changing input signals into sharply defined, jitter-free output signals.

### QUICK REFERENCE DATA

GND = 0 V;  $T_{amb} = 25$  °C.

SYMBOL	PARAMETER	CONDITIONS	TYPICAL	UNIT
$t_{PHL}/t_{PLH}$	propagation delay inputs nA to output nY	$V_{CC} = 1.8$ V; $C_L = 30$ pF; $R_L = 1$ k $\Omega$	5.6	ns
		$V_{CC} = 2.5$ V; $C_L = 30$ pF; $R_L = 500$ $\Omega$	3.7	ns
		$V_{CC} = 2.7$ V; $C_L = 50$ pF; $R_L = 500$ $\Omega$	3.8	ns
		$V_{CC} = 3.3$ V; $C_L = 50$ pF; $R_L = 500$ $\Omega$	3.6	ns
		$V_{CC} = 5.0$ V; $C_L = 50$ pF; $R_L = 500$ $\Omega$	2.7	ns
$C_I$	input capacitance		3.5	pF
$C_{PD}$	power dissipation capacitance per buffer	$V_{CC} = 3.3$ V; notes 1 and 2	16.3	pF

### Notes

1.  $C_{PD}$  is used to determine the dynamic power dissipation ( $P_D$  in  $\mu$ W).

$$P_D = C_{PD} \times V_{CC}^2 \times f_i \times N + \sum (C_L \times V_{CC}^2 \times f_o) \text{ where:}$$

$f_i$  = input frequency in MHz;

$f_o$  = output frequency in MHz;

$C_L$  = output load capacitance in pF;

$V_{CC}$  = supply voltage in Volts;

$N$  = total load switching outputs;

$\sum (C_L \times V_{CC}^2 \times f_o)$  = sum of outputs.

2. The condition is  $V_I = \text{GND to } V_{CC}$ .

## Dual non-inverting Schmitt-trigger with 5 V tolerant input

74LVC2G17

### FUNCTION TABLE

See note 1.

INPUT		OUTPUT	
nA		nY	
L		L	
H		H	

### Note

1. H = HIGH voltage level;  
L = LOW voltage level.

### ORDERING INFORMATION

TYPE NUMBER	PACKAGES					
	TEMPERATURE RANGE	PINS	PACKAGE	MATERIAL	CODE	MARKING
74LVC2G17GW	-40 to +125 °C	6	SC-88	plastic	SOT363	VV
74LVC2G17GV	-40 to +125 °C	6	SC-74	plastic	SOT457	V17

### PINNING

PIN	SYMBOL	DESCRIPTION
1	1A	data input
2	GND	ground (0 V)
3	2A	data input
4	2Y	data output
5	V <sub>CC</sub>	supply voltage
6	1Y	data output

# Dual non-inverting Schmitt-trigger with 5 V tolerant input

## 74LVC2G17

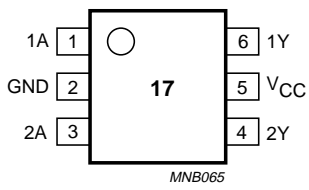

Fig.1 Pin configuration.

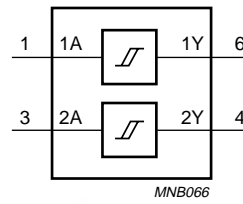

Fig.2 Logic symbol.

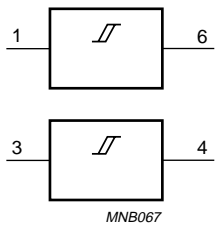

Fig.3 IEC logic symbol.

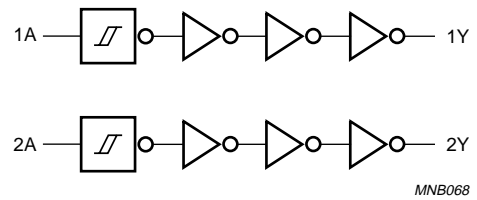

Fig.4 Logic diagram.

## Dual non-inverting Schmitt-trigger with 5 V tolerant input

74LVC2G17

### RECOMMENDED OPERATING CONDITIONS

SYMBOL	PARAMETER	CONDITIONS	MIN.	MAX.	UNIT
$V_{CC}$	supply voltage		1.65	5.5	V
$V_I$	input voltage		0	5.5	V
$V_O$	output voltage		0	$V_{CC}$	V
$T_{amb}$	operating ambient temperature		-40	+125	°C
$t_r, t_f$	input rise and fall times	$V_{CC} = 1.65$ to $2.7$ V	0	20	ns/V
		$V_{CC} = 2.7$ to $5.5$ V	0	10	ns/V

### LIMITING VALUES

In accordance with the Absolute Maximum Rating System (IEC 60134); voltages are referenced to GND (ground = 0 V).

SYMBOL	PARAMETER	CONDITIONS	MIN.	MAX.	UNIT
$V_{CC}$	supply voltage		-0.5	+6.5	V
$I_{IK}$	input diode current	$V_I < 0$	-	-50	mA
$V_I$	input voltage	note 1	-0.5	+6.5	V
$I_{OK}$	output diode current	$V_O > V_{CC}$ or $V_O < 0$	-	±50	mA
$V_O$	output voltage	active mode; notes 1 and 2	-0.5	$V_{CC} + 0.5$	V
		Power-down mode; notes 1 and 2	-0.5	+6.5	V
$I_O$	output source or sink current	$V_O = 0$ to $V_{CC}$	-	±50	mA
$I_{CC}, I_{GND}$	$V_{CC}$ or GND current		-	±100	mA
$T_{stg}$	storage temperature		-65	+150	°C
$P_D$	power dissipation	$T_{amb} = -40$ to $+125$ °C	-	300	mW

### Notes

1. The input and output voltage ratings may be exceeded if the input and output current ratings are observed.
2. When  $V_{CC} = 0$  V (Power-down mode), the output voltage can be 5.5 V in normal operation.

Dual non-inverting Schmitt-trigger with  
5 V tolerant input

74LVC2G17

**DC CHARACTERISTICS**

At recommended operating conditions; voltages are referenced to GND (ground = 0 V).

SYMBOL	PARAMETER	TEST CONDITIONS		MIN.	TYP. <sup>(1)</sup>	MAX.	UNIT
		OTHER	V <sub>CC</sub> (V)				
<b>T<sub>amb</sub> = -40 to +85 °C</b>							
V <sub>OL</sub>	LOW-level output voltage	V <sub>I</sub> = V <sub>IH</sub> or V <sub>IL</sub>	1.65 to 5.5	–	–	0.1	V
		I <sub>O</sub> = 100 μA	1.65	–	–	0.45	V
		I <sub>O</sub> = 4 mA	2.3	–	–	0.3	V
		I <sub>O</sub> = 8 mA	2.7	–	–	0.4	V
		I <sub>O</sub> = 12 mA	3.0	–	–	0.55	V
		I <sub>O</sub> = 24 mA	4.5	–	–	0.55	V
		I <sub>O</sub> = 32 mA					
V <sub>OH</sub>	HIGH-level output voltage	V <sub>I</sub> = V <sub>IH</sub> or V <sub>IL</sub>	1.65 to 5.5	V <sub>CC</sub> – 0.1	–	–	V
		I <sub>O</sub> = –100 μA	1.65	1.2	–	–	V
		I <sub>O</sub> = –4 mA	2.3	1.9	–	–	V
		I <sub>O</sub> = –8 mA	2.7	2.2	–	–	V
		I <sub>O</sub> = –12 mA	3.0	2.3	–	–	V
		I <sub>O</sub> = –24 mA	4.5	3.8	–	–	V
		I <sub>O</sub> = –32 mA					
I <sub>LI</sub>	input leakage current	V <sub>I</sub> = 5.5 V or GND	5.5	–	±0.1	±5	μA
I <sub>off</sub>	power OFF leakage current	V <sub>I</sub> or V <sub>O</sub> = 5.5 V	0	–	±0.1	±10	μA
I <sub>CC</sub>	quiescent supply current	V <sub>I</sub> = V <sub>CC</sub> or GND; I <sub>O</sub> = 0	5.5	–	0.1	10	μA
ΔI <sub>CC</sub>	additional quiescent supply current per pin	V <sub>I</sub> = V <sub>CC</sub> – 0.6 V; I <sub>O</sub> = 0	2.3 to 5.5	–	5	500	μA

Dual non-inverting Schmitt-trigger with  
5 V tolerant input

74LVC2G17

SYMBOL	PARAMETER	TEST CONDITIONS		MIN.	TYP. <sup>(1)</sup>	MAX.	UNIT
		OTHER	V <sub>CC</sub> (V)				
<b>T<sub>amb</sub> = -40 to +125 °C</b>							
V <sub>OL</sub>	LOW-level output voltage	V <sub>I</sub> = V <sub>IH</sub> or V <sub>IL</sub>	1.65 to 5.5	–	–	0.1	V
		I <sub>O</sub> = 100 μA	1.65	–	–	0.70	V
		I <sub>O</sub> = 4 mA	2.3	–	–	0.45	V
		I <sub>O</sub> = 8 mA	2.7	–	–	0.60	V
		I <sub>O</sub> = 24 mA	3.0	–	–	0.80	V
		I <sub>O</sub> = 32 mA	4.5	–	–	0.80	V
V <sub>OH</sub>	HIGH-level output voltage	V <sub>I</sub> = V <sub>IH</sub> or V <sub>IL</sub>	1.65 to 5.5	V <sub>CC</sub> – 0.1	–	–	V
		I <sub>O</sub> = -100 μA	1.65	0.95	–	–	V
		I <sub>O</sub> = -4 mA	2.3	1.7	–	–	V
		I <sub>O</sub> = -8 mA	2.7	1.9	–	–	V
		I <sub>O</sub> = -12 mA	3.0	2.0	–	–	V
		I <sub>O</sub> = -24 mA	4.5	3.4	–	–	V
I <sub>LI</sub>	input leakage current	V <sub>I</sub> = 5.5 V or GND	5.5	–	±0.1	±20	μA
I <sub>off</sub>	power OFF leakage current	V <sub>I</sub> or V <sub>O</sub> = 5.5 V	0	–	–	±20	μA
I <sub>CC</sub>	quiescent supply current	V <sub>I</sub> = V <sub>CC</sub> or GND; I <sub>O</sub> = 0	5.5	–	–	40	μA
ΔI <sub>CC</sub>	additional quiescent supply current per pin	V <sub>I</sub> = V <sub>CC</sub> – 0.6 V; I <sub>O</sub> = 0	2.3 to 5.5	–	–	5000	μA

**Note**

- All typical values are measured at V<sub>CC</sub> = 3.3 V and T<sub>amb</sub> = 25 °C.

Dual non-inverting Schmitt-trigger with  
5 V tolerant input

74LVC2G17

**TRANSFER CHARACTERISTICS**

Voltages are referenced to GND (ground = 0 V).

SYMBOL	PARAMETER	TEST CONDITIONS		MIN.	TYP. <sup>(1)</sup>	MAX.	UNIT
		WAVEFORMS	V <sub>CC</sub> (V)				
<b>T<sub>amb</sub> = -40 to +85 °C</b>							
V <sub>T+</sub>	positive-going threshold	see Figs 5 and 6	1.8	0.70	1.10	1.50	V
			2.3	1.00	1.40	1.80	V
			3.0	1.30	1.76	2.20	V
			4.5	1.90	2.47	3.10	V
			5.5	2.20	2.91	3.60	V
V <sub>T-</sub>	negative-going threshold	see Figs 5 and 6	1.8	0.25	0.61	0.90	V
			2.3	0.40	0.80	1.15	V
			3.0	0.60	1.04	1.50	V
			4.5	1.00	1.55	2.00	V
			5.5	1.20	1.86	2.30	V
V <sub>H</sub>	hysteresis (V <sub>T+</sub> - V <sub>T-</sub> )	see Figs 5, 6 and 7	1.8	0.15	0.49	1.00	V
			2.3	0.25	0.60	1.10	V
			3.0	0.40	0.73	1.20	V
			4.5	0.60	0.92	1.50	V
			5.5	0.70	1.02	1.70	V
<b>T<sub>amb</sub> = -40 to +125 °C</b>							
V <sub>T+</sub>	positive-going threshold	see Figs 5 and 6	1.8	0.70	–	1.70	V
			2.3	1.00	–	2.00	V
			3.0	1.30	–	2.40	V
			4.5	1.90	–	3.30	V
			5.5	2.20	–	3.80	V
V <sub>T-</sub>	negative-going threshold	see Figs 5 and 6	1.8	0.25	–	1.10	V
			2.3	0.40	–	1.35	V
			3.0	0.60	–	1.70	V
			4.5	1.00	–	2.20	V
			5.5	1.20	–	2.50	V
V <sub>H</sub>	hysteresis (V <sub>T+</sub> - V <sub>T-</sub> )	see Figs 5, 6 and 7	1.8	0.15	–	1.20	V
			2.3	0.25	–	1.30	V
			3.0	0.40	–	1.40	V
			4.5	0.60	–	1.70	V
			5.5	0.70	–	1.90	V

**Notes**

1. All typical values are measured at T<sub>amb</sub> = 25 °C.



Dual non-inverting Schmitt-trigger with 5 V tolerant input

74LVC2G17

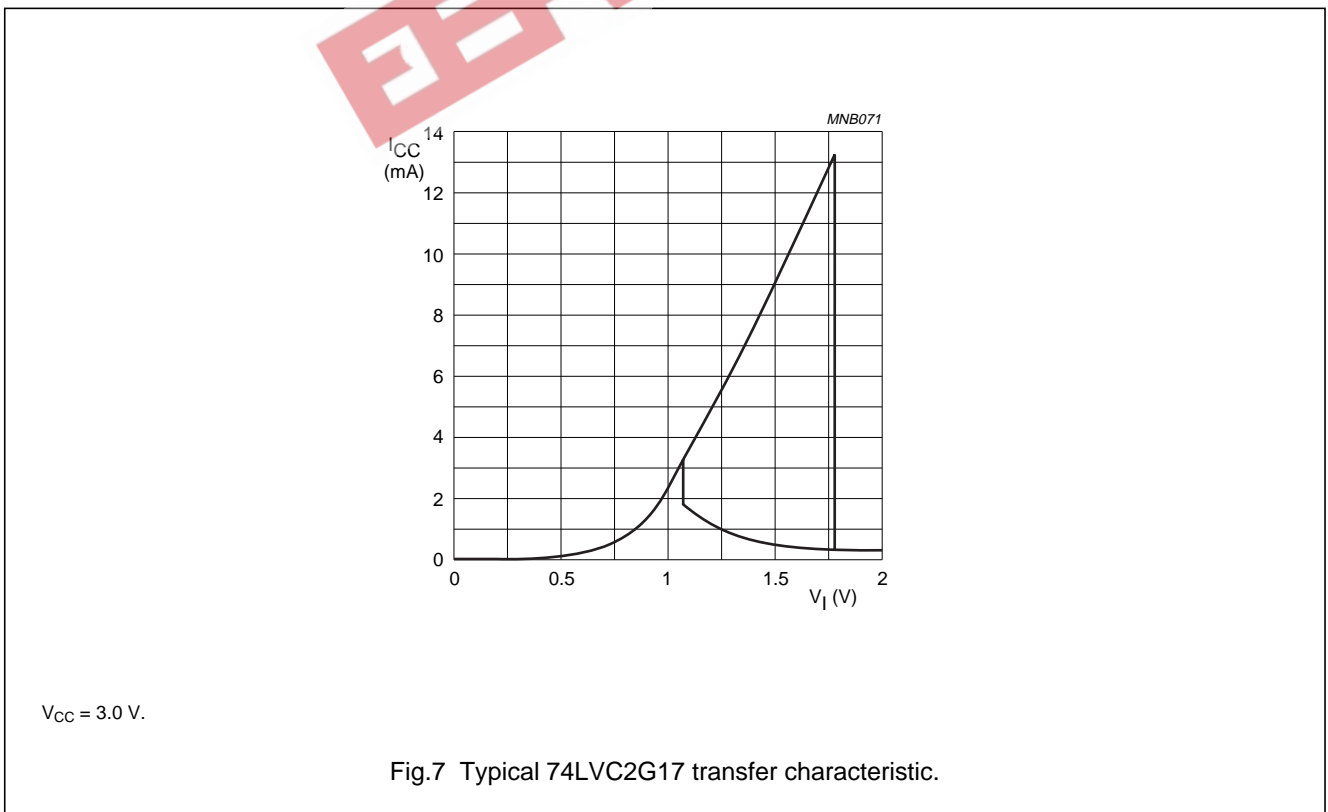
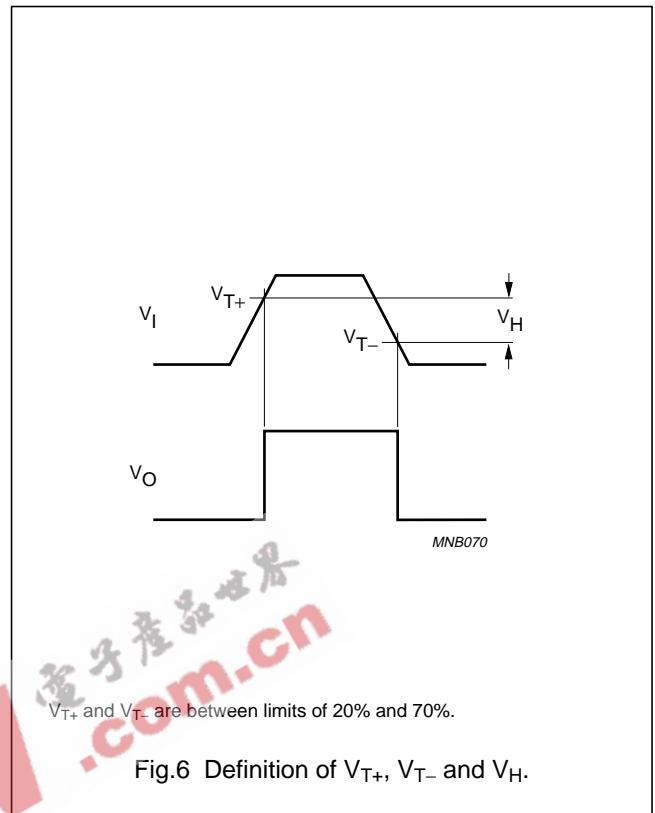
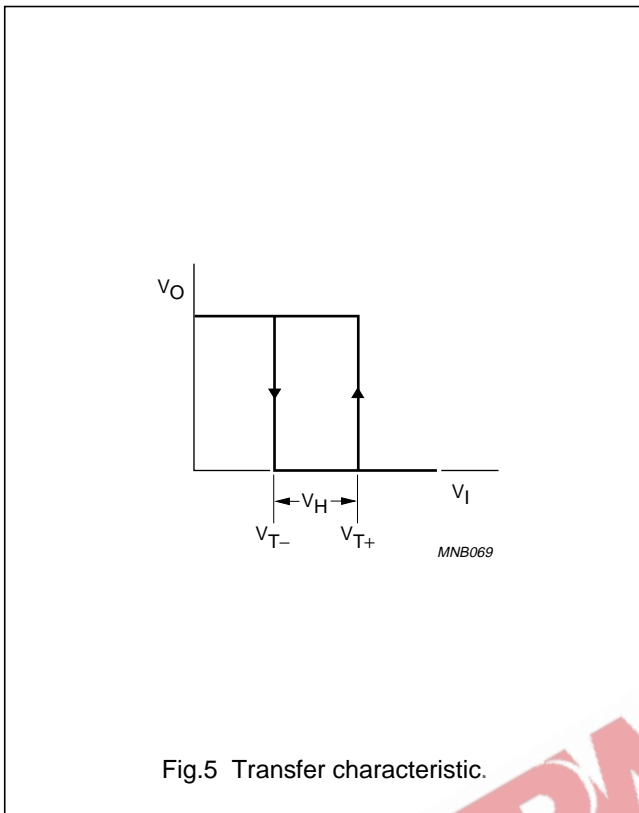

Dual non-inverting Schmitt-trigger with  
5 V tolerant input

74LVC2G17

## AC CHARACTERISTICS

GND = 0 V.

SYMBOL	PARAMETER	TEST CONDITIONS		MIN.	TYP. <sup>(1)</sup>	MAX.	UNIT
		WAVEFORMS	V <sub>CC</sub> (V)				
<b>T<sub>amb</sub> = -40 to +85 °C</b>							
t <sub>PHL</sub> /t <sub>PLH</sub>	propagation delay nA to nY	see Figs 8 and 9	1.65 to 1.95	1.5	5.6	10.5	ns
			2.3 to 2.7	1.0	3.7	6.5	ns
			2.7	1.0	3.8	6.5	ns
			3.0 to 3.6	1.0	3.6	5.7	ns
			4.5 to 5.5	1.0	2.7	4.3	ns
<b>T<sub>amb</sub> = -40 to +125 °C</b>							
t <sub>PHL</sub> /t <sub>PLH</sub>	propagation delay nA to nY	see Figs 8 and 9	1.65 to 1.95	1.5	–	13.1	ns
			2.3 to 2.7	1.0	–	8.5	ns
			2.7	1.0	–	8.5	ns
			3.0 to 3.6	1.0	–	7.1	ns
			4.5 to 5.5	1.0	–	5.4	ns

## Note

1. All typical values are measured at T<sub>amb</sub> = 25 °C.

# Dual non-inverting Schmitt-trigger with 5 V tolerant input

74LVC2G17

## AC WAVEFORMS

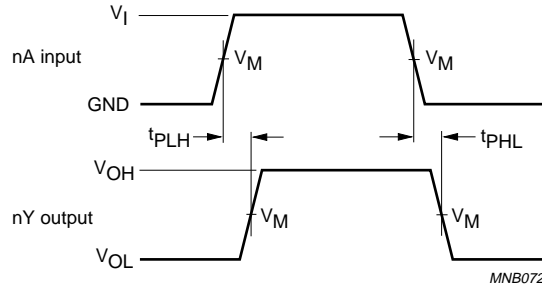

V <sub>CC</sub>	V <sub>M</sub>	INPUT	
		V <sub>I</sub>	t <sub>r</sub> = t <sub>f</sub>
1.65 to 1.95 V	0.5 × V <sub>CC</sub>	V <sub>CC</sub>	≤ 2.0 ns
2.3 to 2.7 V	0.5 × V <sub>CC</sub>	V <sub>CC</sub>	≤ 2.0 ns
2.7 V	1.5 V	2.7 V	≤ 2.5 ns
3.0 to 3.6 V	1.5 V	2.7 V	≤ 2.5 ns
4.5 to 5.5 V	0.5 × V <sub>CC</sub>	V <sub>CC</sub>	≤ 2.5 ns

V<sub>OL</sub> and V<sub>OH</sub> are typical output voltage drop that occur with the output load.

Fig.8 The input (nA) to output (nY) propagation delays and the output transition times.

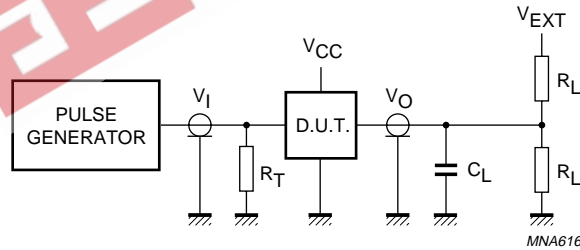

V <sub>CC</sub>	V <sub>I</sub>	C <sub>L</sub>	R <sub>L</sub>	V <sub>EXT</sub>		
				t <sub>PLH</sub> /t <sub>PHL</sub>	t <sub>PZH</sub> /t <sub>PHZ</sub>	t <sub>PZL</sub> /t <sub>PLZ</sub>
1.65 to 1.95 V	V <sub>CC</sub>	30 pF	1 kΩ	open	GND	2 × V <sub>CC</sub>
2.3 to 2.7 V	V <sub>CC</sub>	30 pF	500 Ω	open	GND	2 × V <sub>CC</sub>
2.7 V	2.7 V	50 pF	500 Ω	open	GND	6 V
3.0 to 3.6 V	2.7 V	50 pF	500 Ω	open	GND	6 V
4.5 to 5.5 V	V <sub>CC</sub>	50 pF	500 Ω	open	GND	2 × V <sub>CC</sub>

Definitions for test circuit:

R<sub>L</sub> = Load resistor.

C<sub>L</sub> = Load capacitance including jig and probe capacitance.

R<sub>T</sub> = Termination resistance should be equal to the output impedance Z<sub>o</sub> of the pulse generator.

Fig.9 Load circuitry for switching times.

# Dual non-inverting Schmitt-trigger with 5 V tolerant input

74LVC2G17

## APPLICATION INFORMATION

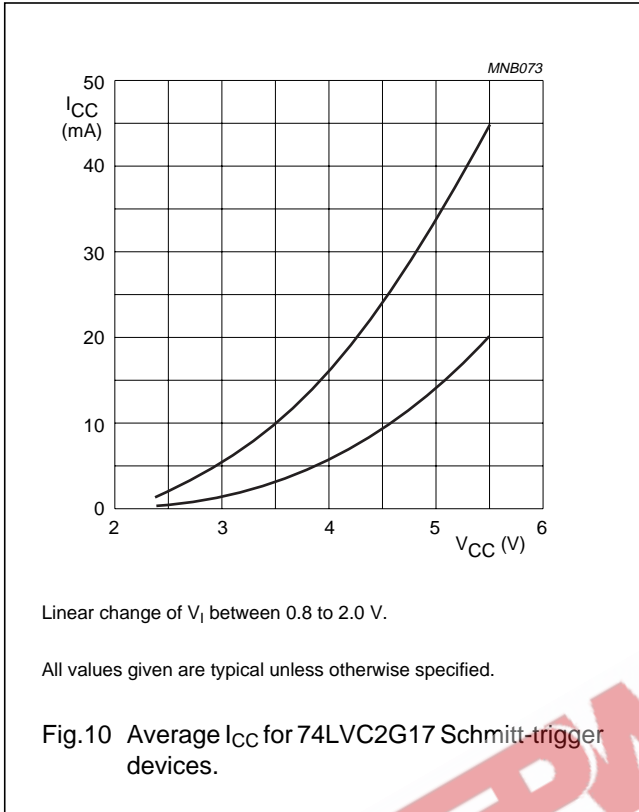

EPW.com.cn 电子产品世界

# Dual non-inverting Schmitt-trigger with 5 V tolerant input

74LVC2G17

## PACKAGE OUTLINES

Plastic surface mounted package; 6 leads

SOT363

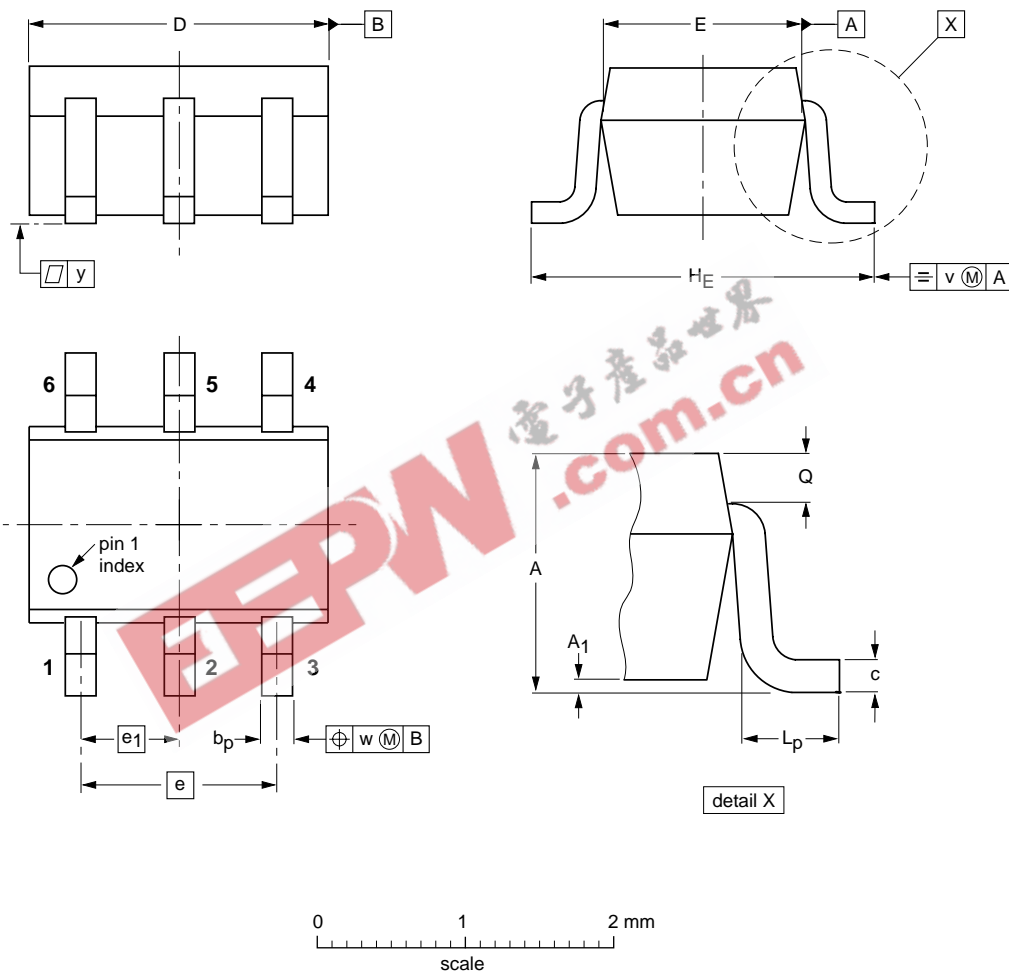

DIMENSIONS (mm are the original dimensions)

UNIT	A	A <sub>1</sub> max	b <sub>p</sub>	c	D	E	e	e <sub>1</sub>	H <sub>E</sub>	L <sub>p</sub>	Q	v	w	y
mm	1.1 0.8	0.1	0.30 0.20	0.25 0.10	2.2 1.8	1.35 1.15	1.3	0.65	2.2 2.0	0.45 0.15	0.25 0.15	0.2	0.2	0.1

OUTLINE VERSION	REFERENCES				EUROPEAN PROJECTION	ISSUE DATE
	IEC	JEDEC	EIAJ			
SOT363			SC-88			97-02-28

Dual non-inverting Schmitt-trigger with  
5 V tolerant input

74LVC2G17

Plastic surface mounted package; 6 leads

SOT457

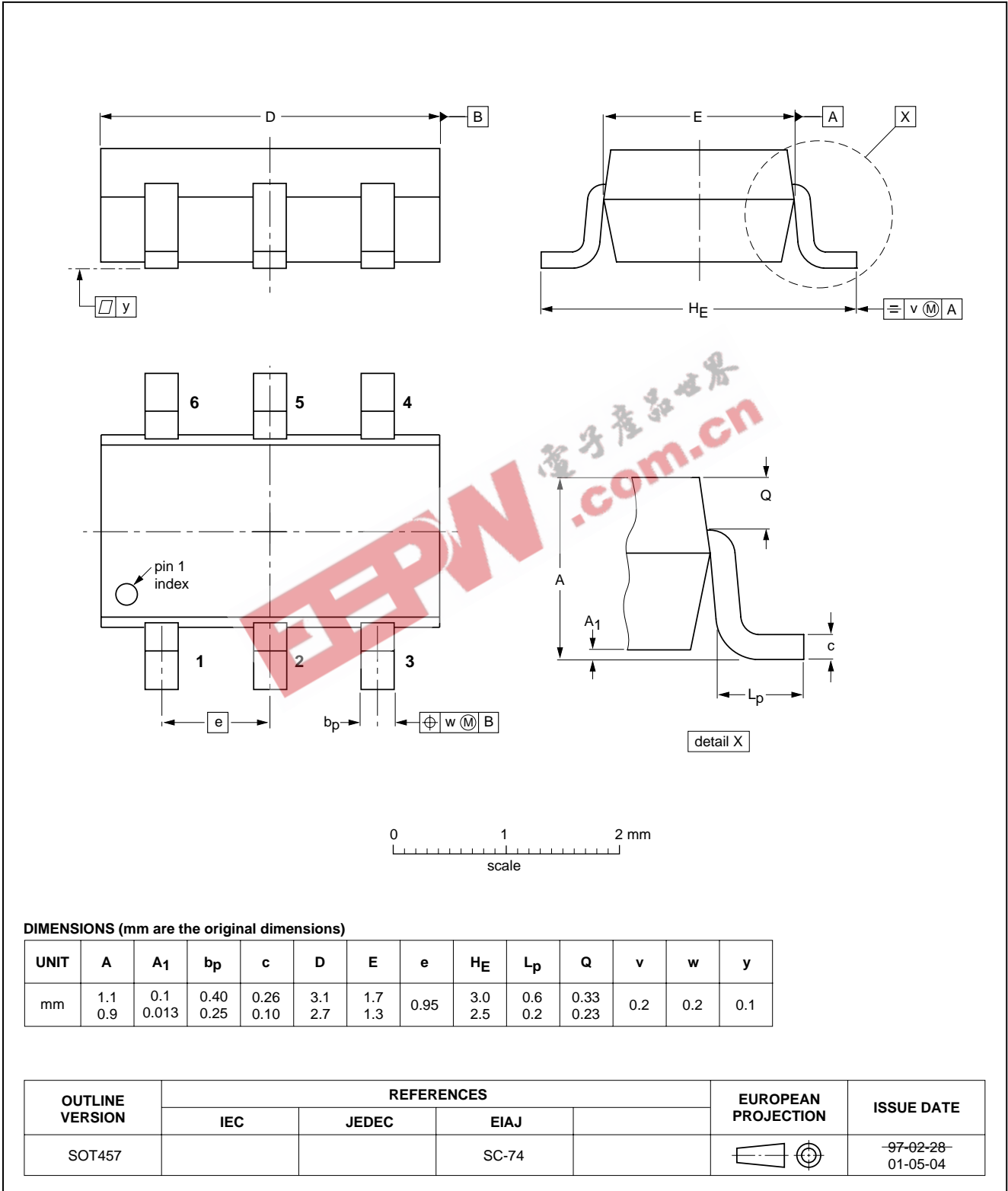

## Dual non-inverting Schmitt-trigger with 5 V tolerant input

74LVC2G17

### DATA SHEET STATUS

LEVEL	DATA SHEET STATUS <sup>(1)</sup>	PRODUCT STATUS <sup>(2)(3)</sup>	DEFINITION
I	Objective data	Development	This data sheet contains data from the objective specification for product development. Philips Semiconductors reserves the right to change the specification in any manner without notice.
II	Preliminary data	Qualification	This data sheet contains data from the preliminary specification. Supplementary data will be published at a later date. Philips Semiconductors reserves the right to change the specification without notice, in order to improve the design and supply the best possible product.
III	Product data	Production	This data sheet contains data from the product specification. Philips Semiconductors reserves the right to make changes at any time in order to improve the design, manufacturing and supply. Relevant changes will be communicated via a Customer Product/Process Change Notification (CPCN).

### Notes

1. Please consult the most recently issued data sheet before initiating or completing a design.
2. The product status of the device(s) described in this data sheet may have changed since this data sheet was published. The latest information is available on the Internet at URL <http://www.semiconductors.philips.com>.
3. For data sheets describing multiple type numbers, the highest-level product status determines the data sheet status.

### DEFINITIONS

**Short-form specification** — The data in a short-form specification is extracted from a full data sheet with the same type number and title. For detailed information see the relevant data sheet or data handbook.

**Limiting values definition** — Limiting values given are in accordance with the Absolute Maximum Rating System (IEC 60134). Stress above one or more of the limiting values may cause permanent damage to the device. These are stress ratings only and operation of the device at these or at any other conditions above those given in the Characteristics sections of the specification is not implied. Exposure to limiting values for extended periods may affect device reliability.

**Application information** — Applications that are described herein for any of these products are for illustrative purposes only. Philips Semiconductors make no representation or warranty that such applications will be suitable for the specified use without further testing or modification.

### DISCLAIMERS

**Life support applications** — These products are not designed for use in life support appliances, devices, or systems where malfunction of these products can reasonably be expected to result in personal injury. Philips Semiconductors customers using or selling these products for use in such applications do so at their own risk and agree to fully indemnify Philips Semiconductors for any damages resulting from such application.

**Right to make changes** — Philips Semiconductors reserves the right to make changes in the products - including circuits, standard cells, and/or software - described or contained herein in order to improve design and/or performance. When the product is in full production (status 'Production'), relevant changes will be communicated via a Customer Product/Process Change Notification (CPCN). Philips Semiconductors assumes no responsibility or liability for the use of any of these products, conveys no licence or title under any patent, copyright, or mask work right to these products, and makes no representations or warranties that these products are free from patent, copyright, or mask work right infringement, unless otherwise specified.

# ***Philips Semiconductors – a worldwide company***

## **Contact information**

For additional information please visit <http://www.semiconductors.philips.com>. Fax: +31 40 27 24825

For sales offices addresses send e-mail to: [sales.addresses@www.semiconductors.philips.com](mailto:sales.addresses@www.semiconductors.philips.com).

EEPW.com.cn 电子世界

© Koninklijke Philips Electronics N.V. 2003

SCA75

All rights are reserved. Reproduction in whole or in part is prohibited without the prior written consent of the copyright owner.

The information presented in this document does not form part of any quotation or contract, is believed to be accurate and reliable and may be changed without notice. No liability will be accepted by the publisher for any consequence of its use. Publication thereof does not convey nor imply any license under patent- or other industrial or intellectual property rights.

Printed in The Netherlands

613508/01/pp16

Date of release: 2003 Aug 13

Document order number: 9397 750 11688

*Let's make things better.*

**Philips  
Semiconductors**



**PHILIPS**