

FEATURES

- -55°C to 100°C
- 4 to 6.5, 9 to 15, or 20 to 32 VDC input
- Fully isolated
- Output regulated from input side
- 100 kHz typical switching frequency
- Topology – Push-Pull DC/DC Converter
- Up to 75% efficiency
- No minimum load
- Output capacitor suggested

DC/DC CONVERTERS 5, 12, OR 28 VOLT INPUT

DCH SERIES 3 WATT

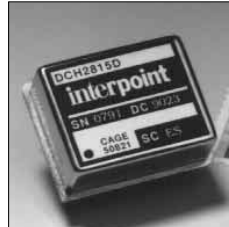

MODELS	
VDC OUTPUT	
SINGLES	DUALS
5	±12
12	±15
28	±28

Size (max.): 0.975 x 0.800 x 0.350 inches (24.77 x 20.32 x 8.89 mm)
See section B8, case A3, for dimensions.
Weight: 20 grams typical
Screening: Standard or ES. See Section C2 for screening options, see Section A5 for ordering information.

DESCRIPTION

The DCH Series™ offers isolated, unregulated DC/DC converters with up to 3 watts of output power in a low profile (0.350 max.) metal package. Single and dual output models are available with input voltages of 5, 12, or 28 VDC. DCH Series converters operate over a -55°C to +100°C temperature range.

DCH Series converters use a non-saturating core circuit operating at a frequency of approximately 100 kHz, which reduces reflected input ripple and minimizes EMI/RFI problems. For applications requiring MIL-STD-461C, CEO3, reflected input ripple levels, refer to Section B5 or contact your Interpoint representative for matching EMI filters.

Figure 1 shows a standard connection scheme for a dual output model. Users may also elect to use a dual output device to provide a single output at double the rated output voltage. The double voltage connection is achieved by leaving the normal output common pin (Pin 15) unconnected and using either the positive or negative Vout pin for the output common connection.

On all DCH Series models, a tantalum capacitor with a minimum value of 22 µF and an appropriate voltage rating should be connected between the output common and the output line(s) to minimize output ripple.

**FIGURE 1:
DUAL DCH CONVERTER
WITH EXTERNAL CAPACITORS**

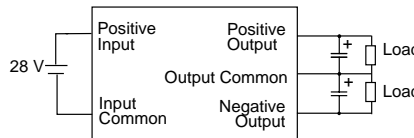

Typical Performance Curves: 25°C Tc , nominal Vin

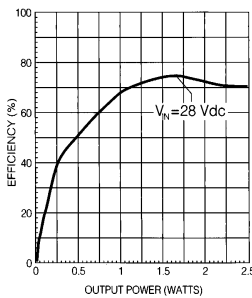

Efficiency
DCH2805S
FIGURE 2



Output Current vs Output Voltage
DCH2805S
FIGURE 3



Efficiency
DCH1215D
FIGURE 4



Output Current vs Output Voltage
DCH1215D
FIGURE 5

DCH SERIES 3 WATT

DC/DC CONVERTERS

ABSOLUTE MAXIMUM RATING

Output Power

- 3 watts

Lead Soldering Temperature (10 sec per lead)

- 300°C

Storage Temperature Range (Case)

- -55°C to +125°C

RECOMMENDED OPERATING CONDITION

Input Voltage Range (VDC)

- 5 volt input models 4.0 to 6.5
- 12 volt input models 9.0 to 15.0
- 28 volt input models 20.0 to 32.0

Case Operating Temperature (Tc)

- -55°C to +100°C full power

TYPICAL CHARACTERISTIC

Output Voltage Tolerance (Full Load)

- 5 volt output models ±0.25
- 12 volt output models ±0.4
- 15 volt output models ±0.5
- 28 volt output models ±0.6

Line Regulation

- Output is directly proportional to input voltage.

Output Voltage Temperature Coefficient

- 0.02%/°C maximum

Converter Frequency

- 100 kHz typical

Isolation

- 100 megohm minimum at 500 V

Electrical Characteristics: 25°C Tc, 28 VDC Vin, 100% load, unless otherwise specified.

MODEL NUMBER	INPUT VOLTAGE	OUTPUT VOLTAGE ¹	OUTPUT CURRENT	OUTPUT POWER	EFFICIENCY FULL LOAD	LOAD REGULATION	INPUT CURRENT ²	OUTPUT RIPPLE ²	
			Tc = -55°C	Tc = -55°C		50% TO		10% LOAD	MAX
			TO +100°C	TO +100°C		FULL LOAD			
NOMINAL VDC	NOMINAL VDC	MAX mA	MAX W	MIN %	TYP mV	MAX mA	MAX mVp-p		
DCH0505S	5	5	400	2.0	67	470	220	300	
DCH0512S	5	12	208	2.5	72	830	250	200	
DCH0512D	5	±12	±104	2.5	72	830	250	100	
DCH0515D	5	±15	±83	2.5	72	830	250	100	
DCH1205S	12	5	500	2.5	70	500	110	300	
DCH1212S	12	12	250	3.0	72	440	70	200	
DCH1228S	12	28	107	3.0	75	870	110	300	
DCH1212D	12	±12	±125	3.0	72	440	110	100	
DCH1215D	12	±15	±100	3.0	72	440	110	100	
DCH1228D	12	±28	±53	3.0	75	870	110	200	
DCH2805S	28	5	500	2.5	68	450	50	300	
DCH2812S	28	12	250	3.0	75	375	50	200	
DCH2812D	28	±12	±125	3.0	75	375	50	100	
DCH2815D	28	±15	±100	3.0	75	375	50	100	

Notes

1. Nominal output voltage is correct only for nominal input voltage. Output voltage changes in proportion to input voltage.
2. Output ripple results require the connection of a tantalum capacitor (22 µF minimum) across each output.

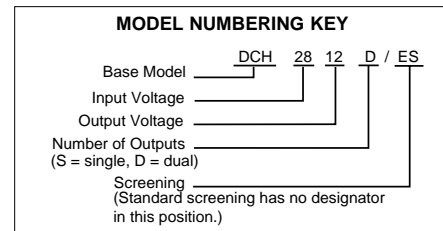
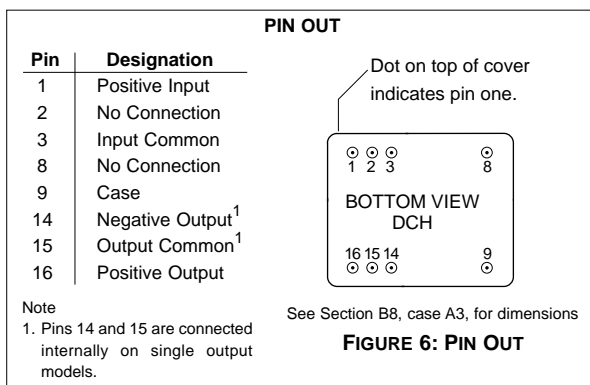

24600-001-DTS Rev A DQ# 1024

All technical information is believed to be accurate, but no responsibility is assumed for errors or omissions. Interpoint reserves the right to make changes in products or specifications without notice. DCH Series is a trademark of Interpoint. Copyright © 1991 - 1999 Interpoint. All rights reserved.

CASE A

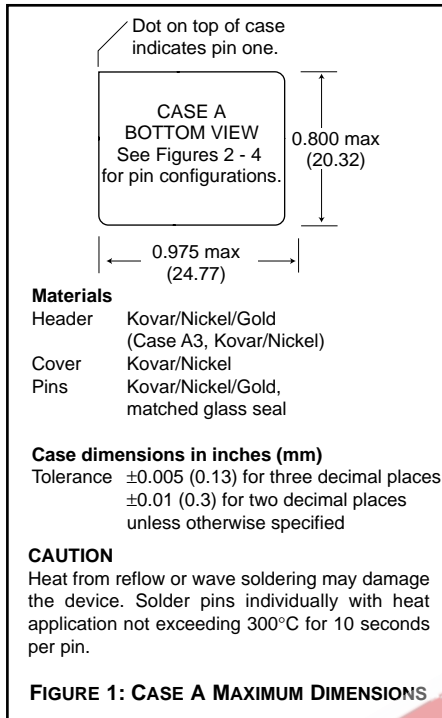

CASES

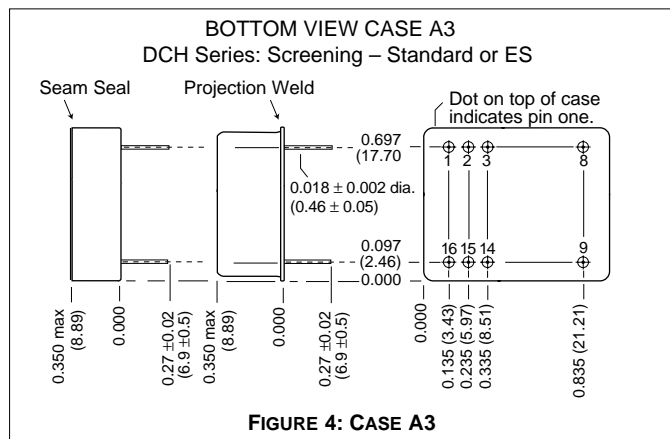
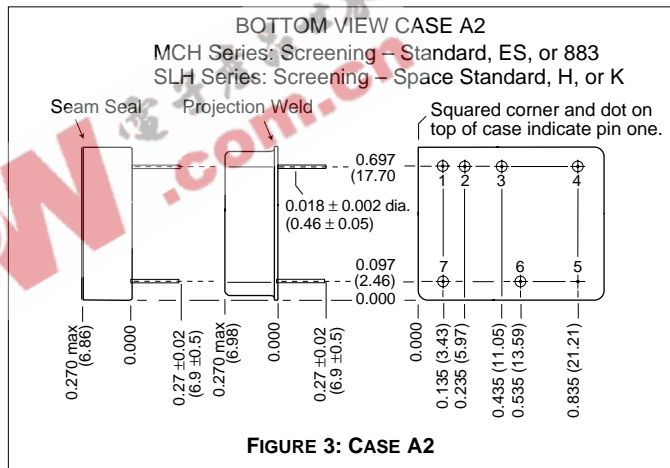
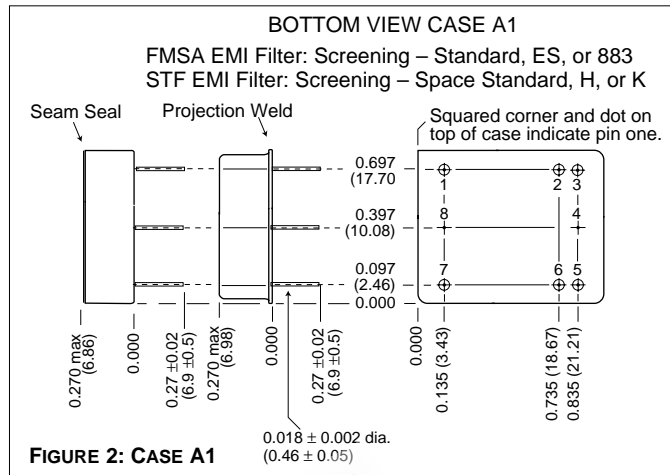

Note: Although every effort has been made to render the case drawings at actual size, variations in the printing process may cause some distortion. Please refer to the numerical dimensions for accuracy.

**QA SCREENING
85°C PRODUCTS**

85°C PRODUCTS

TEST (85°C Products excluding HR products)	STANDARD	/ES
PRE-CAP INSPECTION Method 2017	yes	yes
TEMPERATURE CYCLE (10 times) Method 1010, Cond. B, -55°C to 125°C	no	yes
CONSTANT ACCELERATION Method 2001, 500 g	no	yes
BURN-IN 96 hours at 70°C ambient (typical)	no	yes
FINAL ELECTRICAL TEST MIL-PRF-38534, Group A Subgroups 1 and 4: +25°C case	yes	yes
HERMETICITY TESTING Fine Leak, Method 1014, Cond. A	no	yes
Gross Leak, Method 1014, Cond. C	no	yes
Gross Leak, Dip (1 x 10 ⁻³)	yes	no
FINAL VISUAL INSPECTION Method 2009	yes	yes

Test methods are referenced to MIL-STD-883 as determined by MIL-PRF-38534.

Applies to the following products:

MFW Series
MTW Series
MHE/MLP Series
MHL Series
MRH Series
MTO Series
MSR Series
DCH Series
FM/FMA/FMB EMI Filters
MSF EMI Filter