

**FEATURES**

- -55°C to 100°C
- 4 to 6.5, 9 to 15, or 20 to 32 VDC input
- Fully isolated
- Output regulated from input side
- 100 kHz typical switching frequency
- Topology – Push-Pull DC/DC Converter
- Up to 75% efficiency
- No minimum load
- Output capacitor suggested

# DC/DC CONVERTERS 5, 12, OR 28 VOLT INPUT

## DCH SERIES 3 WATT



MODELS	
VDC OUTPUT	
SINGLES	DUALS
5	±12
12	±15
28	±28

Size (max.): 0.975 x 0.800 x 0.350 inches (24.77 x 20.32 x 8.89 mm)  
See section B8, case A3, for dimensions.  
Weight: 20 grams typical  
Screening: Standard or ES. See Section C2 for screening options, see Section A5 for ordering information.

**DESCRIPTION**

The DCH Series™ offers isolated, unregulated DC/DC converters with up to 3 watts of output power in a low profile (0.350 max.) metal package. Single and dual output models are available with input voltages of 5, 12, or 28 VDC. DCH Series converters operate over a -55°C to +100°C temperature range.

DCH Series converters use a non-saturating core circuit operating at a frequency of approximately 100 kHz, which reduces reflected input ripple and minimizes EMI/RFI problems. For applications requiring MIL-STD-461C, CEO3, reflected input ripple levels, refer to Section B5 or contact your Interpoint representative for matching EMI filters.

Figure 1 shows a standard connection scheme for a dual output model. Users may also elect to use a dual output device to provide a single output at double the rated output voltage. The double voltage connection is achieved by leaving the normal output common pin (Pin 15) unconnected and using either the positive or negative Vout pin for the output common connection.

On all DCH Series models, a tantalum capacitor with a minimum value of 22 µF and an appropriate voltage rating should be connected between the output common and the output line(s) to minimize output ripple.

**FIGURE 1:  
DUAL DCH CONVERTER  
WITH EXTERNAL CAPACITORS**

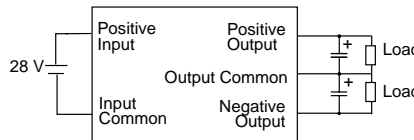

**Typical Performance Curves: 25°C Tc , nominal Vin**

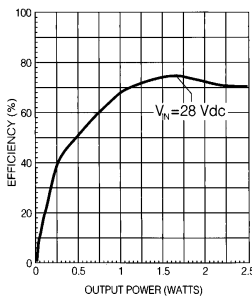

Efficiency  
DCH2805S  
**FIGURE 2**

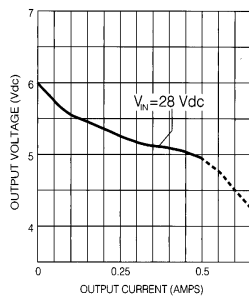

Output Current vs Output Voltage  
DCH2805S  
**FIGURE 3**

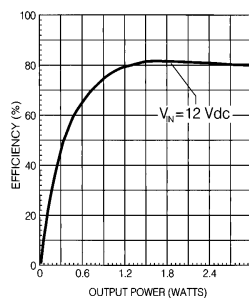

Efficiency  
DCH1215D  
**FIGURE 4**

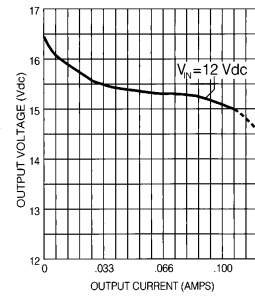

Output Current vs Output Voltage  
DCH1215D  
**FIGURE 5**



A CRANE CO. COMPANY

# DCH SERIES 3 WATT

# DC/DC CONVERTERS

**ABSOLUTE MAXIMUM RATING**  
**Output Power**  
 • 3 watts  
**Lead Soldering Temperature (10 sec per lead)**  
 • 300°C  
**Storage Temperature Range (Case)**  
 • -55°C to +125°C

**RECOMMENDED OPERATING CONDITION**  
**Input Voltage Range (VDC)**  
 • 5 volt input models 4.0 to 6.5  
 • 12 volt input models 9.0 to 15.0  
 • 28 volt input models 20.0 to 32.0  
**Case Operating Temperature (Tc)**  
 • -55°C to +100°C full power

**TYPICAL CHARACTERISTIC**  
**Output Voltage Tolerance (Full Load)**  
 • 5 volt output models ±0.25  
 • 12 volt output models ±0.4  
 • 15 volt output models ±0.5  
 • 28 volt output models ±0.6  
**Line Regulation**  
 • Output is directly proportional to input voltage.  
**Output Voltage Temperature Coefficient**  
 • 0.02%/°C maximum  
**Converter Frequency**  
 • 100 kHz typical  
**Isolation**  
 • 100 megohm minimum at 500 V

**Electrical Characteristics: 25°C Tc, 28 VDC Vin, 100% load, unless otherwise specified.**

MODEL NUMBER	INPUT VOLTAGE  NOMINAL VDC	OUTPUT VOLTAGE <sup>1</sup>  NOMINAL VDC	OUTPUT CURRENT	OUTPUT POWER	EFFICIENCY FULL LOAD	LOAD REGULATION	INPUT CURRENT <sup>2</sup> 10% LOAD MAX mA	OUTPUT RIPPLE <sup>2</sup>
			Tc = -55°C TO +100°C	Tc = -55°C TO +100°C		50% TO FULL LOAD		MAX
			MAX mA	MAX W		MIN %		TYP mV
DCH0505S	5	5	400	2.0	67	470	220	300
DCH0512S	5	12	208	2.5	72	830	250	200
DCH0512D	5	±12	±104	2.5	72	830	250	100
DCH0515D	5	±15	±83	2.5	72	830	250	100
DCH1205S	12	5	500	2.5	70	500	110	300
DCH1212S	12	12	250	3.0	72	440	70	200
DCH1228S	12	28	107	3.0	75	870	110	300
DCH1212D	12	±12	±125	3.0	72	440	110	100
DCH1215D	12	±15	±100	3.0	72	440	110	100
DCH1228D	12	±28	±53	3.0	75	870	110	200
DCH2805S	28	5	500	2.5	68	450	50	300
DCH2812S	28	12	250	3.0	75	375	50	200
DCH2812D	28	±12	±125	3.0	75	375	50	100
DCH2815D	28	±15	±100	3.0	75	375	50	100

**Notes**

- Nominal output voltage is correct only for nominal input voltage. Output voltage changes in proportion to input voltage.
- Output ripple results require the connection of a tantalum capacitor (22 µF minimum) across each output.

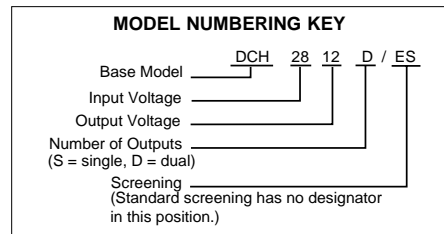
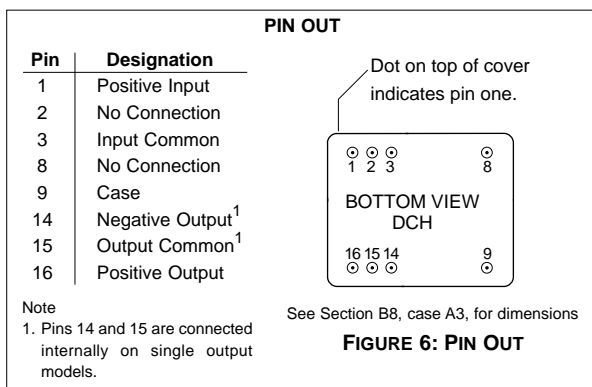

24600-001-DTS Rev A DQ# 1024

All technical information is believed to be accurate, but no responsibility is assumed for errors or omissions. Interpoint reserves the right to make changes in products or specifications without notice. DCH Series is a trademark of Interpoint. Copyright © 1991 - 1999 Interpoint. All rights reserved.

## CASE A

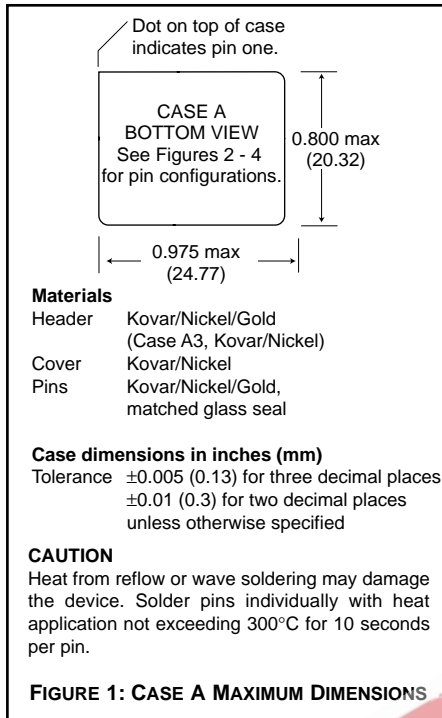

## CASES

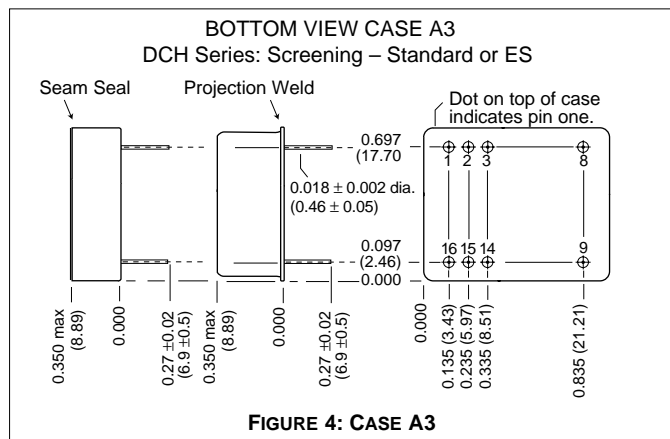
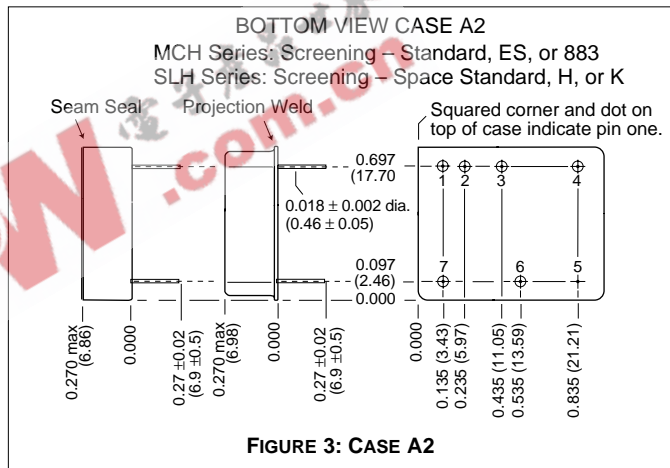
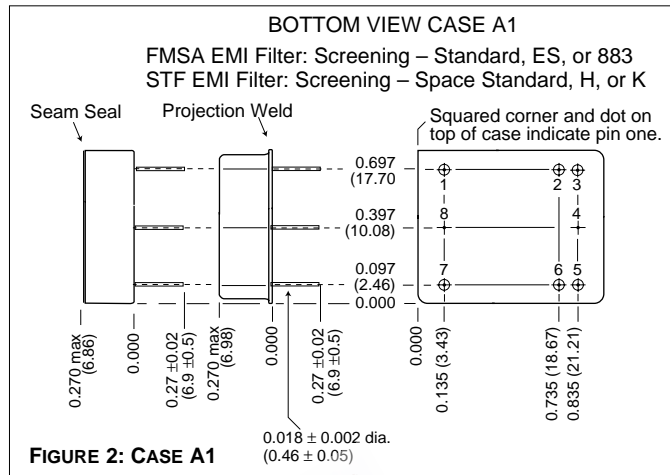

Note: Although every effort has been made to render the case drawings at actual size, variations in the printing process may cause some distortion. Please refer to the numerical dimensions for accuracy.

**QA SCREENING  
85°C PRODUCTS**

**85°C PRODUCTS**

<b>TEST (85°C Products excluding HR products)</b>	<b>STANDARD</b>	<b>/ES</b>
PRE-CAP INSPECTION Method 2017	yes	yes
TEMPERATURE CYCLE (10 times) Method 1010, Cond. B, -55°C to 125°C	no	yes
CONSTANT ACCELERATION Method 2001, 500 g	no	yes
BURN-IN 96 hours at 70°C ambient (typical)	no	yes
FINAL ELECTRICAL TEST MIL-PRF-38534, Group A Subgroups 1 and 4: +25°C case	yes	yes
HERMETICITY TESTING Fine Leak, Method 1014, Cond. A	no	yes
Gross Leak, Method 1014, Cond. C	no	yes
Gross Leak, Dip (1 x 10 <sup>-3</sup> )	yes	no
FINAL VISUAL INSPECTION Method 2009	yes	yes

Test methods are referenced to MIL-STD-883 as determined by MIL-PRF-38534.

Applies to the following products:

MFW Series  
MTW Series  
MHE/MLP Series  
MHL Series  
MRH Series  
MTO Series  
MSR Series  
DCH Series  
FM/FMA/FMB EMI Filters  
MSF EMI Filter