



600 mA/1000 mA, 2.5 MHz Buck-Boost DC-to-DC Converter

Preliminary Technical Data

ADP2503/ADP2504

FEATURES

- 1 mm height profile
- Compact PCB footprint
- Seamless transition between modes
- 38 μ A typical quiescent current
- 2.5 MHz operation enables 1 μ H inductor
- Input voltage: 2.3 V to 5.5 V
- Fixed output voltage: 2.8 V to 5.0 V
- 600 mA (ADP2503) and 1000 mA (ADP2504) output options
- Boost converter configuration with load disconnect
- Sync pin with three different modes:
 - Power save mode (PSM) for improved light load efficiency
 - Forced fixed frequency operation mode
 - Synchronization with external clock
- Internal compensation
- Soft start
- Enable/shutdown logic input
- Overtemperature protection
- Short-circuit protection
- Undervoltage lockout protection
- Small 10-lead 3 mm \times 3 mm LFCSP/QFN package

APPLICATIONS

- Wireless handsets
- Digital cameras/portable audio players
- Miniature hard disk power supplies
- USB powered devices

GENERAL DESCRIPTION

The ADP2503/ADP2504 are high efficiency, low quiescent current step-up/step-down dc-to-dc converters that can operate at input voltages above, below, or equal to the regulated output voltage. The power switches and synchronous rectifiers are internal to minimize external part count. At high load currents, the ADP2503/ADP2504 use a current-mode, fixed frequency PWM control scheme for optimal stability and transient response. To ensure the longest battery life in portable applications, the ADP2503/ADP2504 have an optional power save mode that reduces the switching frequency under light load conditions. For wireless and other low noise applications where variable frequency power save mode may cause interference, the logic control input sync forces fixed frequency PWM operation under all load conditions.

The ADP2503/ADP2504 can run from input voltages between 2.3 V and 5.5 V, allowing single lithium or lithium polymer cell, multiple alkaline or NiMH cells, PCMCIA, USB, and other standard power sources. The ADP2503/ADP2504 have fixed output options ranging from 2.8 V to 5 V. Compensation is internal to minimize the number of external components.

During logic-controlled shutdown, the input is disconnected from the output and draws less than 1 μ A from the input source. Operating as a boost converter, the ADP2503/ADP2504 feature a true load disconnect function that isolates the load from the power source. Other key features include under voltage lockout to prevent deep battery discharge and soft start to prevent input current overshoot at startup.

TYPICAL APPLICATION CIRCUIT

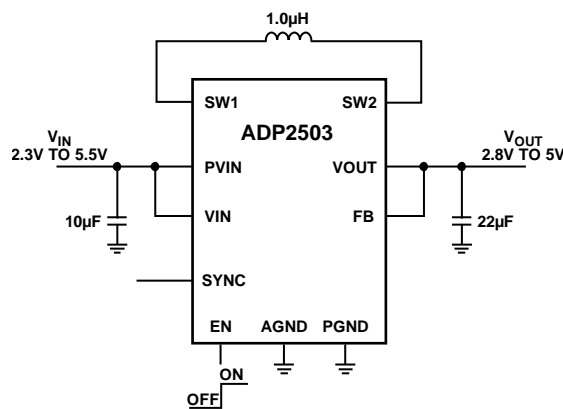

Figure 1. Application Circuit

Rev. PrB

Information furnished by Analog Devices is believed to be accurate and reliable. However, no responsibility is assumed by Analog Devices for its use, nor for any infringements of patents or other rights of third parties that may result from its use. Specifications subject to change without notice. No license is granted by implication or otherwise under any patent or patent rights of Analog Devices. Trademarks and registered trademarks are the property of their respective owners.

One Technology Way, P.O. Box 9106, Norwood, MA 02062-9106, U.S.A.
Tel: 781.329.4700
Fax: 781.461.3113
www.analog.com
©2008 Analog Devices, Inc. All rights reserved.

TABLE OF CONTENTS

Features	1	Reverse Current Limit	10
Applications.....	1	Power save Mode.....	10
General Description	1	Soft Start	10
Typical Application Circuit	1	Enable.....	11
Revision History	2	Undervoltage Lockout	11
Specifications.....	3	Thermal Shutdown	11
Absolute Maximum Ratings.....	4	Short Circuit Protection	11
Thermal Resistance	4	Applications Information	12
ESD Caution.....	4	Inductor Selection	12
Pin Configuration and Function Description	5	PCB Layout Guidelines.....	14
Typical Performance Characteristics	6	Outline Dimensions	15
Theory of Operation	10	Ordering Guide	15

REVISION HISTORY

8/08—Revision PrB

EEPW 电子产品世界
.com.cn

SPECIFICATIONS

$V_{IN} = 3.6\text{ V}$, $V_{OUT} = 3.3\text{ V}$, @ $T_A = T_J = -40^\circ\text{C}$ to $+125^\circ\text{C}$ for minimum/maximum specifications and $T_A = +25^\circ\text{C}$ for typical specifications, unless otherwise noted.¹

Table 1.

Parameters	Conditions	Min	Typ	Max	Unit
INPUT CHARACTERISTICS					
Input Voltage Range		2.3		5.5	V
Undervoltage Lockout Threshold	V_{IN} rising	2.2	2.25	2.3	V
Undervoltage Lockout Threshold	V_{IN} falling	2.13	2.18	2.23	V
OUTPUT CHARACTERISTICS					
Output Voltage Range		2.8		5.0	V
Feedback Voltage		0.495	0.5	0.55	V
Feedback Impedance			450		k Ω
Output Voltage Initial Accuracy (PWM Mode, No Load)	ADP2503/ADP2504 (PWM operation, no load)	-2		+2	%
Load and Line Regulation	$V_{IN} = 2.3\text{ V}$ to 3.6 V , $I_{LOAD} = 0\text{ mA}$ to 500 mA , forced PWM mode			0.5	%
	$V_{IN} = 2.3\text{ V}$ to 5.5 V , $I_{LOAD} = 0\text{ mA}$ to 500 mA , forced PWM mode			0.6	%
CURRENT CHARACTERISTICS					
Quiescent Current (V_{IN})	$I_{OUT} = 0\text{ mA}$, V mode = EN = $V_{IN} = 3.6\text{ V}$, device not switching		38	50	μA
Shutdown Current	$T_A = T_J = -40^\circ\text{C}$ to $+85^\circ\text{C}$		0.2	1	μA
SWITCH CHARACTERISTICS					
N-Channel Switches (LFCSP)	$V_{IN} = 3.6\text{ V}$		150		m Ω
P-Channel Switches (LFCSP)	$V_{IN} = V_{OUT} = 3.6\text{ V}$		150		m Ω
P-Channel Leakage	$T_J = -40^\circ\text{C}$ to $+85^\circ\text{C}$			1	μA
Switch Current Limit					A
ADP2504		1.3		2.0	A
ADP2503		1.0		1.4	A
Reverse Current Limit				1.1	A
OSCILLATOR AND STARTUP					
Oscillator Frequency	$V_{IN} = 2.3\text{ V}$ to 5.5 V	2.2	2.5	2.8	MHz
On Time PMOS1 (Buck Mode)	Minimum duty cycle = 30%	130			ns
On Time NMOS2 (Boost Mode)	Maximum duty cycle = 50% (x2)			200	ns
Sync Clock Frequency		2.2		2.8	MHz
Sync Clock Minimum Off Time		160			ns
Soft Start Period			200		μs
LOGIC LEVEL CHARACTERISTICS					
EN, SYNC Input High Threshold		1.2			V
EN, SYNC Input Low Threshold				0.4	V
EN, SYNC Leakage Current		-1	+0.1	+1	μA
THERMAL CHARACTERISTICS					
Thermal Shutdown Threshold			150		$^\circ\text{C}$
Thermal Shutdown Hysteresis			25		$^\circ\text{C}$

¹ All limits at temperature extremes are guaranteed via correlation using standard statistical quality control (SQC).

ABSOLUTE MAXIMUM RATINGS

Table 1.

Parameter	Rating
PVIN, VIN, SW1, SW2, VOUT, SYNC, EN, FB	-0.3 V to +6 V
PGND to AGND	-0.3 V to 0.3 V
Operating Ambient Temperature	-40°C to +85°C
Operating Junction Temperature	-40°C to +125°C
Storage Temperature	-65°C to +150°C
Lead Temperature	
Soldering (10 sec)	300°C
Vapor Phase (60 sec)	215°C
Infrared (15 sec)	220°C
ESD Human Body Model	±1000 V
ESD Charged Device Model	±500 V
ESD Machine Model	±100 V

Stresses above those listed under Absolute Maximum Ratings may cause permanent damage to the device. This is a stress rating only; functional operation of the device at these or any other conditions above those indicated in the operational section of this specification is not implied. Exposure to absolute maximum rating conditions for extended periods may affect device reliability.

Absolute maximum ratings apply individually only, not in combination. Unless otherwise specified, all other voltages are referenced to GND.

THERMAL RESISTANCE

θ_{JA} is specified for device soldered JEDEC2S2P PCB. For a typical printed circuit board of a handset, the total thermal resistance is higher. For correct operation up to 85°C ambient temperature the total thermal resistance must not exceed 100 K/W.

Table 2.

Package Type	θ_{JA}	Unit
10-Lead LFCSF (QFN)	84	°C/W

ESD CAUTION



ESD (electrostatic discharge) sensitive device. Charged devices and circuit boards can discharge without detection. Although this product features patented or proprietary protection circuitry, damage may occur on devices subjected to high energy ESD. Therefore, proper ESD precautions should be taken to avoid performance degradation or loss of functionality.

PIN CONFIGURATION AND FUNCTION DESCRIPTION

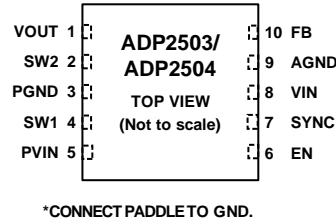

Figure 2. Pin Configuration

Table 3. Pin Function Descriptions

Pin No.	Mnemonic	Description
1	VOUT	The output of the ADP2503/ADP2504. Connect the output capacitor between VOUT and PGND.
2	SW2	Power Switch 2 Connection. This is the internal connection to the input PMOS and NMOS switches. Connect SW2 to the inductor with a short, wide track.
3	PGND	Power GND. Connect the input and output capacitors and PGND pin to a PGND plane.
4	SW1	Power Switch 1 Connection. This is the internal connection to the output PMOS and NMOS switches. Connect SW1 to the inductor with a short, wide track.
5	PVIN	Power Input. This the input to the buck-boost power switches. Place a 10 μ F capacitor between PVIN and PGND as close as possible to the ADP2503/ADP2504.
6	EN	Enable. Drive EN high to turn on the ADP2503/ADP2504. Bring EN low to put the part into shutdown mode.
7	SYNC	The SYNC pin permits the ADP2503/ADP2504 to operate in three different modes. Normal operation: with SYNC driven low, the ADP2503/ADP2504 operates at 2.5 MHz PWM mode for heavy and medium loads, and moves to power save mode (PSM) mode for light loads. Forced PWM operation: with SYNC driven high, the ADP2503/ADP2504 operates at fixed 2.5 MHz PWM mode for all load conditions. SYNC mode: to synchronize the ADP2503/ADP2504 switching to an external signal, drive this pin with a clock between 2.2 MHz and 2.8 MHz. The SYNC signal must have on and off times greater than 160 ns.
8	VIN	Analog Power Supply. This is the supply for the ADP2503/ADP2504 internal circuitry.
9	AGND	Analog Ground.
10	FB	Output Feedback. This is an input to the internal error amplifier.
EP	Paddle	Connect the paddle to PGND.

TYPICAL PERFORMANCE CHARACTERISTICS

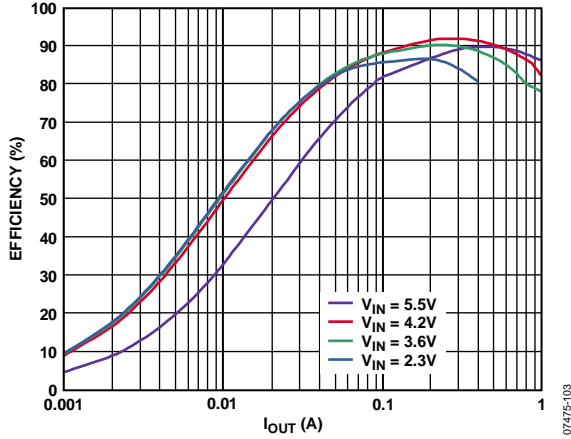

Figure 3. Efficiency vs. Output Current, PWM Mode ($V_{OUT} = 5.0\text{ V}$)

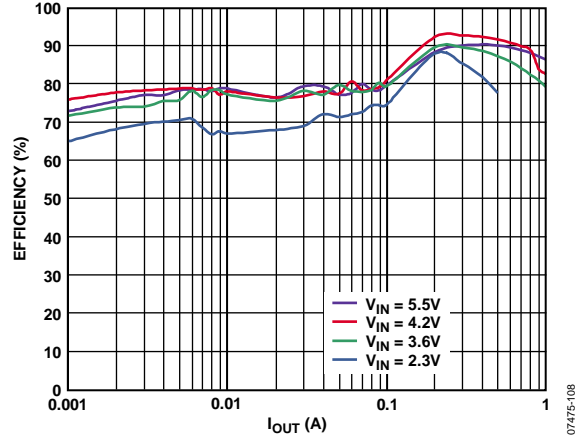

Figure 6. Efficiency vs. Output Current, PSM and PWM Mode ($V_{OUT} = 3.3\text{ V}$)

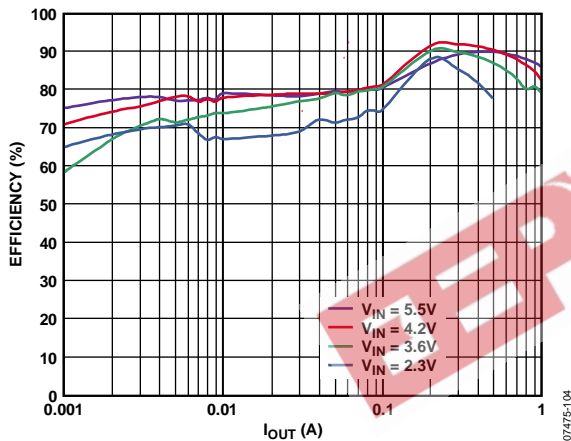

Figure 4. Efficiency vs. Output Current, PSM and PWM Mode ($V_{OUT} = 5.0\text{ V}$)

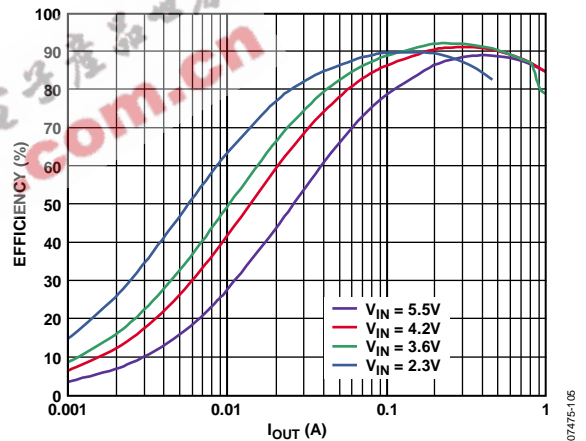

Figure 7. Efficiency vs. Output Current, PWM Mode ($V_{OUT} = 2.8\text{ V}$)

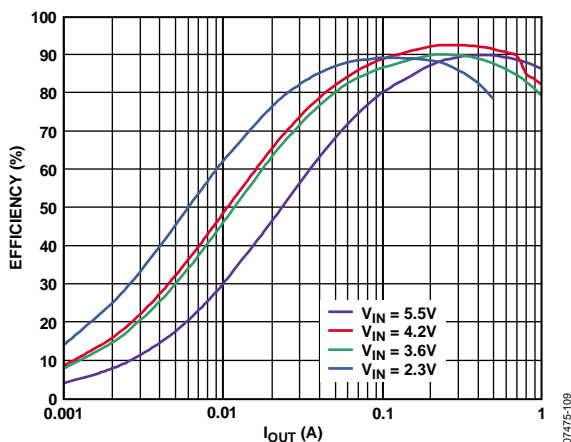

Figure 5. Efficiency vs. Output Current, PWM Mode ($V_{OUT} = 3.3\text{ V}$)

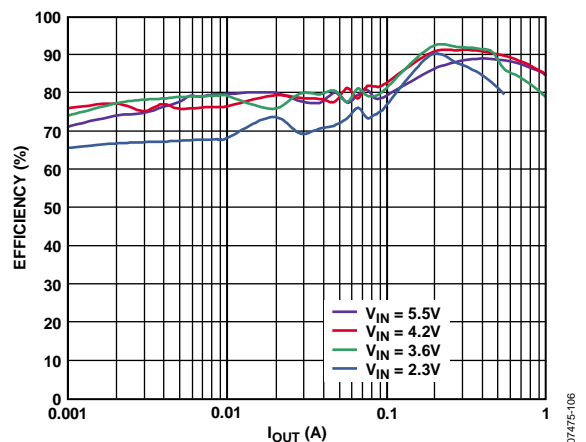

Figure 8. Efficiency vs. Output Current, PSM and PWM Mode ($V_{OUT} = 2.8\text{ V}$)

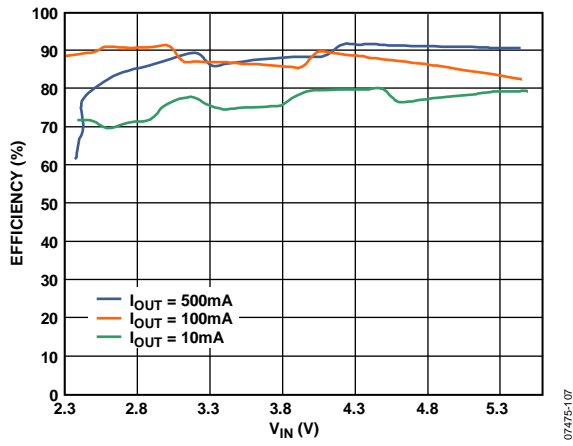

Figure 9. Efficiency vs. Input Voltage ($V_{OUT} = 3.3\text{ V}$)

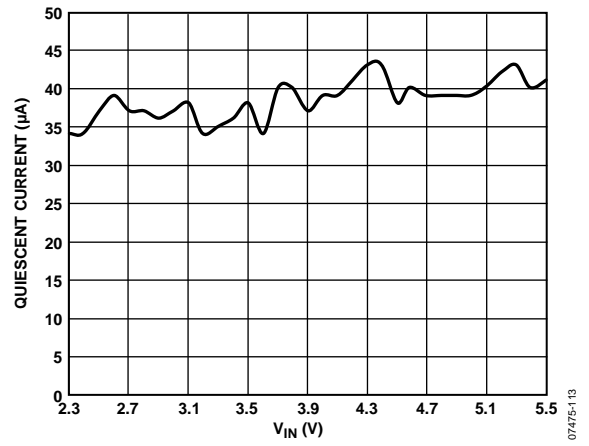

Figure 12. Quiescent Current vs. Input Voltage ($V_{OUT} = 3.3\text{ V}$)

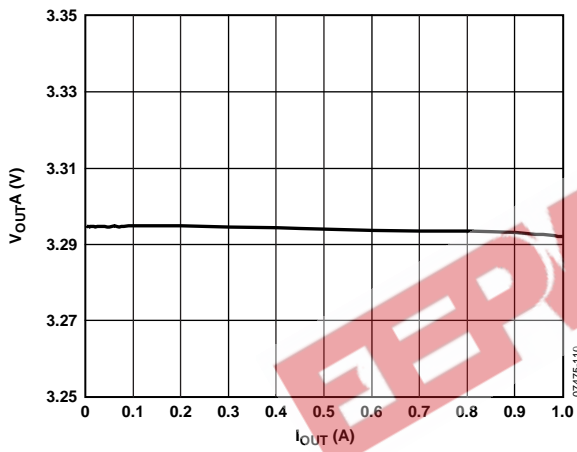

Figure 10. Load Regulation ($V_{IN} = 3.6\text{ V}$, $V_{OUT} = 3.3\text{ V}$)

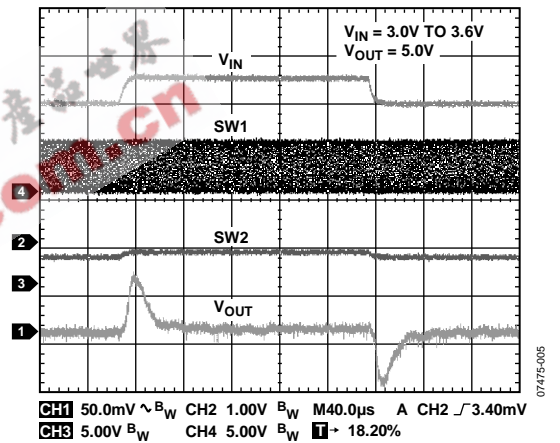

Figure 13. Line Transient, PWM Mode ($V_{IN} = 3.0\text{ V to } 3.6\text{ V}$, $V_{OUT} = 5.0\text{ V}$)

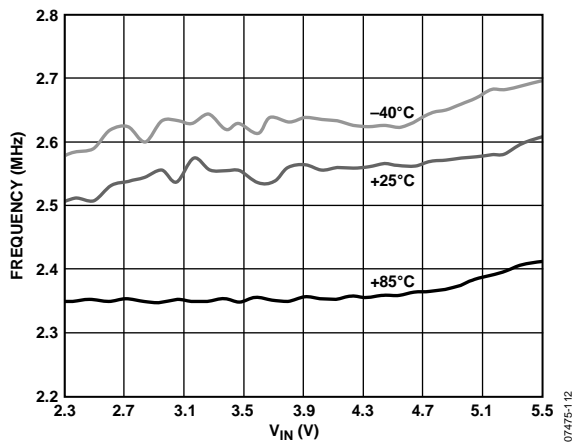

Figure 11. Frequency vs. Input Voltage Over Temperature ($V_{OUT} = 3.3\text{ V}$)

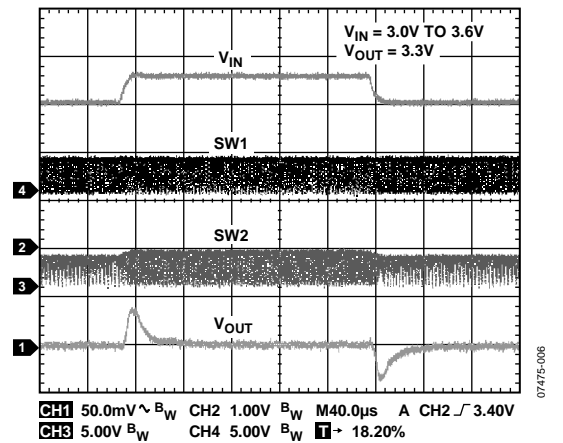

Figure 14. Line Transient, PWM Mode ($V_{IN} = 3.0\text{ V to } 3.6\text{ V}$, $V_{OUT} = 3.3\text{ V}$)

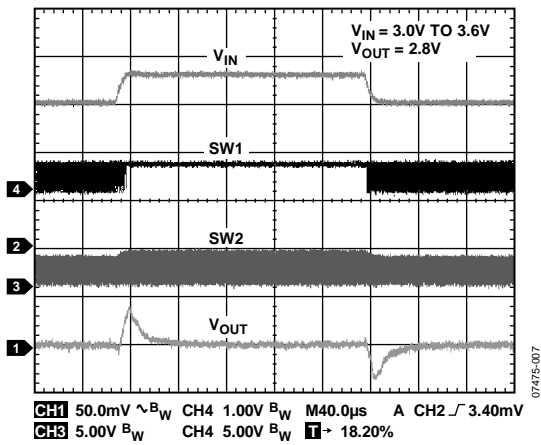

Figure 15. Line Transient, PWM Mode ($V_{IN} = 3.0\text{ V}$ to 3.6 V , $V_{OUT} = 2.8\text{ V}$)

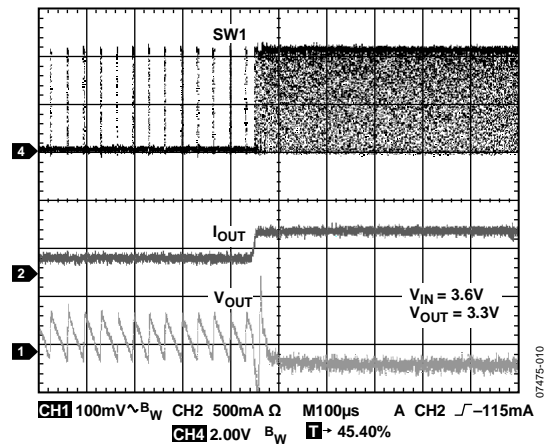

Figure 18. Mode Change by Load Transients, Load Rise ($V_{OUT} = 3.3\text{ V}$)

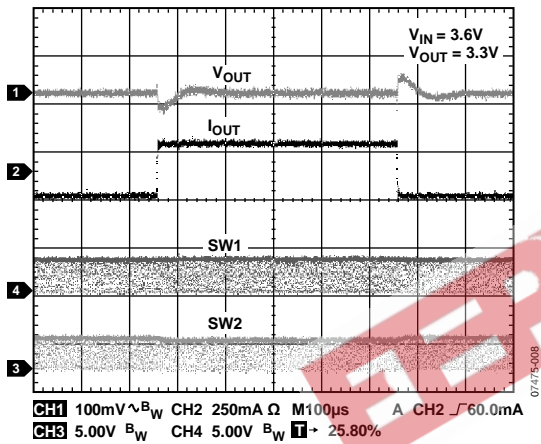

Figure 16. Load Transient ($V_{IN} = 3.6\text{ V}$, $V_{OUT} = 3.3\text{ V}$, $I_{OUT} = 100\text{ mA}$ to 350 mA)

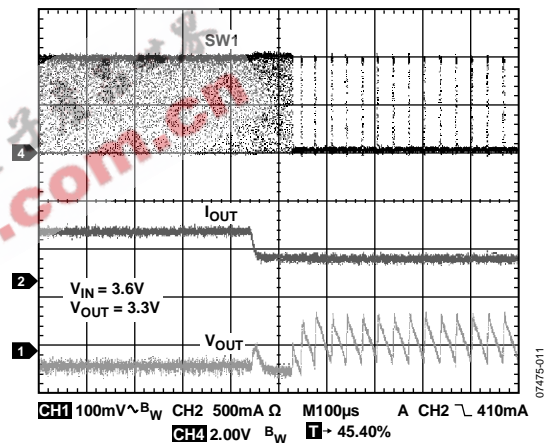

Figure 19. Mode Change by Load Transients, Load Fall ($V_{OUT} = 3.3\text{ V}$)

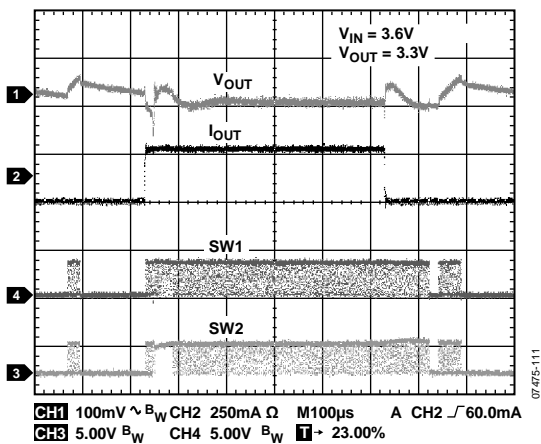

Figure 17. Load Transient ($V_{IN} = 3.6\text{ V}$, $V_{OUT} = 3.3\text{ V}$, $I_{OUT} = 10\text{ mA}$ to 300 mA)

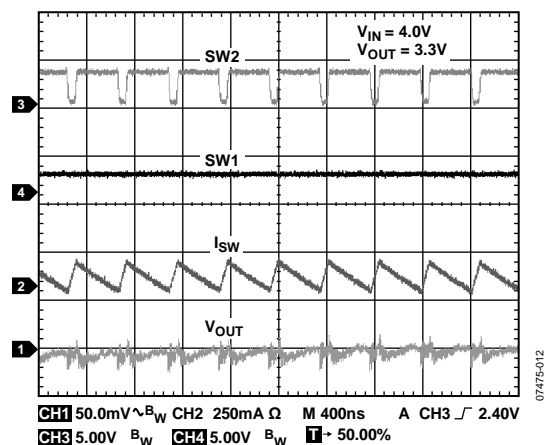

Figure 20. Typical PWM Switching Waveform, Buck Operation ($V_{OUT} = 3.3\text{ V}$)

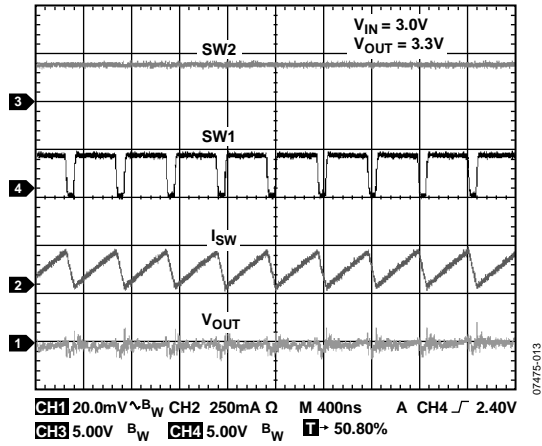

Figure 21. Typical PWM Switching Waveform, Boost Operation ($V_{OUT} = 3.3\text{ V}$)

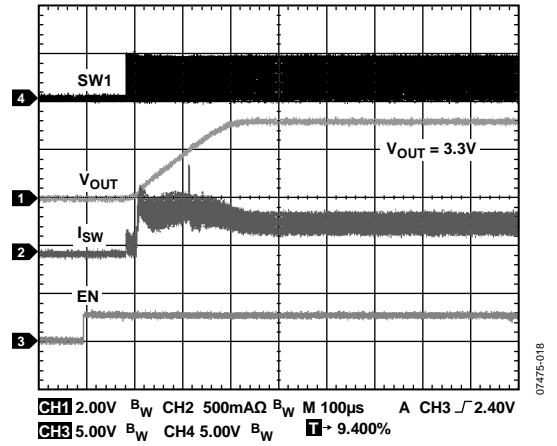

Figure 24. Startup into PWM Mode ($V_{OUT} = 3.3\text{ V}$, $I_{OUT} = 300\text{ mA}$)

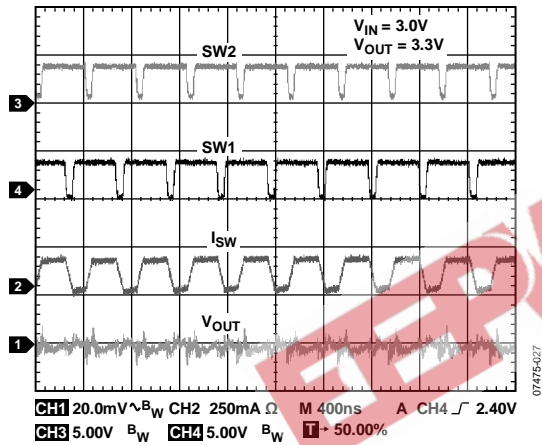

Figure 22. Typical PWM Switching Waveform, Buck-Boost Operation ($V_{OUT} = 3.3\text{ V}$)

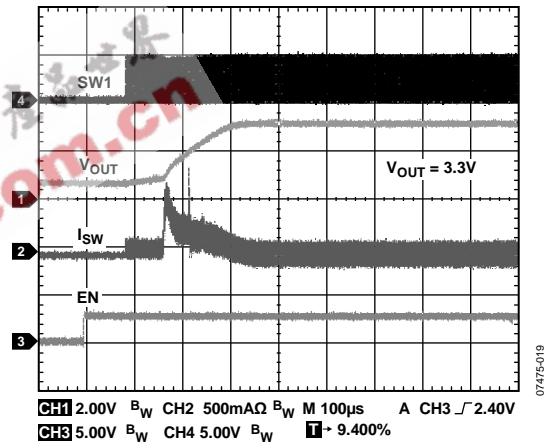

Figure 25. Startup into PWM Mode ($V_{OUT} = 3.3\text{ V}$, $I_{OUT} = 10\text{ mA}$)

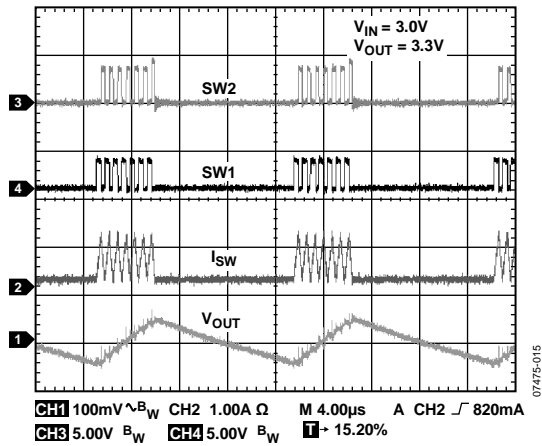

Figure 23. Typical PSM Switching Waveform, Buck-Boost Operation ($V_{OUT} = 3.3\text{ V}$)

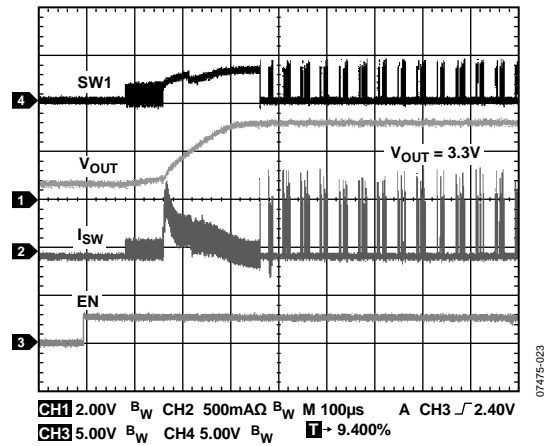

Figure 26. Startup into PSM Mode ($V_{OUT} = 3.3\text{ V}$, $I_{OUT} = 10\text{ mA}$)

THEORY OF OPERATION

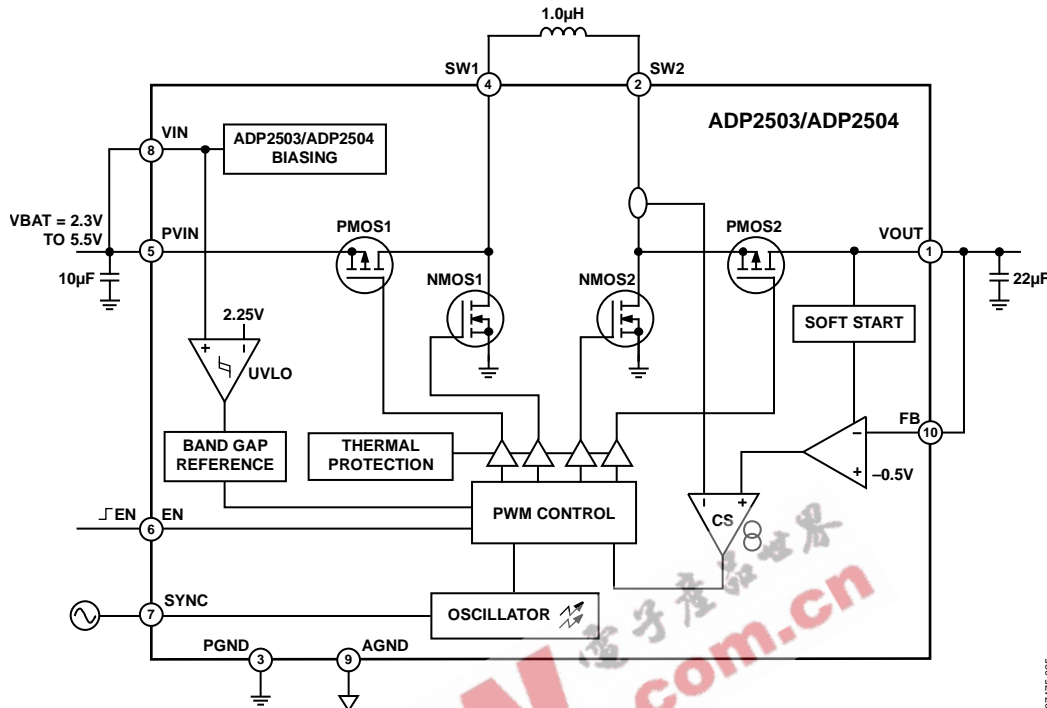

Figure 27. ADP2503/ADP2504 Block Diagram

The ADP2503/ADP2504 are synchronous average current-mode switching buck-boost regulators designed to maintain a fixed output voltage V_{OUT} from an input supply V_{IN} that can be above, equal to, or below V_{OUT} . When V_{IN} is significantly greater than V_{OUT} , the device is in buck mode: PMOS2 is always active, NMOS2 is always off and the switches PMOS1, NMOS1 constitute a buck converter. When V_{IN} is significantly lower than V_{OUT} , the device is in boost mode: PMOS1 is always active, NMOS1 is always off and the switches NMOS2, PMOS2 constitute a boost converter. When V_{IN} is in the range $[V_{OUT} - 10\%; V_{OUT} + 10\%]$, the ADP2503/ADP2504 automatically enter the buck-boost mode. In buck-boost mode, the two operations buck (PMOS1 and NMOS1 switching in antiphase) and boost (NMOS2 and PMOS2 switching in antiphase) take place at each period of the clock. This is aimed at maintaining the regulation and keeping a minimal current ripple in the inductor to guarantee good transient performances.

REVERSE CURRENT LIMIT

In case of a short circuit on V_{OUT} to a value greater than expected, the inductor current becomes negative (reverse current). The negative peak value is limited to 1.1 A by deactivating the switch PMOS2.

POWER SAVE MODE

When the SYNC pin is low, the ADP2503/ADP2504 can operate in power save mode (PSM). In this mode, when the load current becomes lower than 75 mA nominally at $V_{IN} = 3.6$ V, the controller pulls up V_{OUT} and then halts the switching regime until V_{OUT} goes back to a restart value. Then V_{OUT} is pulled up again for a new cycle. This minimizes the switching losses at light load. When the load rises above 150 mA, the ADP2503/ADP2504 revert back to fixed PWM mode. This results in about 75 mA of hysteresis between PSM and fixed PWM, preventing oscillations between these two modes.

SOFT START

When the ADP2503/ADP2504 are started, V_{OUT} is ramped from 0 V to its final programmed value in 200 μ s (typ). This limits the inrush current to less than 600 mA for a nominal output capacitor of 20 μ F. Because the V_{OUT} start-up slope is constant, the inrush current becomes larger if the output capacitor is made larger.

ENABLE

The device starts operation with soft start when the EN pin is brought high. Pulling the EN pin low forces the device into shutdown, with a typical shutdown current of 0.2 μ A.

In this mode, the PMOS power switches are turned off, the NMOS power switches are turned on, and the control circuitry is not enabled. For proper operation, the EN pin must be terminated and must not be left floating.

UNDERVOLTAGE LOCKOUT

The undervoltage lockout circuit prevents the device from operating incorrectly at low input voltages. It prevents the converter from turning on the power switches under undefined conditions and therefore, prevents deep discharge of the battery supply. V_{IN} must be greater than 2.25 V to enable the converter. During operation, if V_{IN} drops below 2.18 V, the ADP2503/ADP2504 are disabled until the supply exceeds the UVLO rising threshold.

THERMAL SHUTDOWN

When the junction temperature, T_J , exceeds 150°C typical, the device goes into thermal shutdown. In this mode, the power switches are turned off. The device resumes operation when the junction temperature again falls below 125°C typical.

SHORT CIRCUIT PROTECTION

When the nominal inductor peak current value of 1.5 A is reached, the ADP2503/ADP2504 first switch off the NMOS2 transistor if it was active. If the current thereafter continues to increase by an extra amount of 200 mA, the PMOS1 transistor is also switched off. This operation is reversible when the short circuit stops. It allows the inductor current ripple to be minimized close to 1.5 A and, thus, the controller to restore V_{OUT} even if a high load current is maintained after the short circuit.

EEPW 电子產品世界
.com.cn

APPLICATIONS INFORMATION

INDUCTOR SELECTION

The high 2.5 MHz switching frequency of the ADP2503/ADP2504 allows for minimal output voltage ripple, while minimizing inductor size and cost. Careful inductor selection also optimizes efficiency and reduces electromagnetic interference (EMI). The selection of the inductor value determines the inductor current ripple and loop dynamics.

$$\Delta I_{L, peak} (Buck) = \frac{V_{OUT} \times (V_{IN} - V_{OUT})}{V_{IN} \times f_{OSC} \times L}$$

$$\Delta I_{L, peak} (Boost) = \frac{(V_{OUT} - V_{IN})}{V_{OUT}} \times \frac{V_{IN}}{f_{OSC} \times L}$$

where f_{OSC} is the switching frequency (typically 2.5 MHz), and L is the inductor value in henries.

A larger inductor value reduces the current ripple (and therefore peak inductor current), but is physically larger in size with increased dc resistance. Inductor values between 1 μ H and 1.5 μ H are usually suggested. The maximum inductor value to ensure stability is 2.0 μ H. For increased efficiency with the ADP2504, it is suggested a 1.5 μ H inductor be used.

The inductor peak current is at the maximum in boost mode. To determine the actual maximum inductor current in boost mode, the input dc current should be estimated.

$$I_{IN(MAX)} = I_{LOAD(MAX)} \times \left(\frac{V_{OUT}}{V_{IN}} \right) \times \frac{1}{\eta}$$

where η is efficiency (assume $\eta \approx 0.85$ to 0.90).

The saturation current rating of the inductor must be at least $I_{IN(MAX)} + \Delta I_{LOAD}/2$.

Ceramic multilayer inductors can be used with lower current designs for a reduced overall solution size and dc resistance (DCR). These are available in low profile packages. Care must be taken as these derate quickly as the inductor value is increased especially at higher operating temperatures.

Ferrite core inductors have good core loss characteristics as well as reasonable dc resistance. A shielded ferrite inductor reduces the EMI generated by the inductor.

Table 5. Recommended Output Capacitors

Vendor	Value	Part No.	Dimensions L x W x H (mm)
Murata	2 x 10 μ F, 6.3 V	GRM188R60J106ME47	1.6 x 0.8 x 0.8 (2)
TDK	2 x 10 μ F, 6.3 V	C1608JB0J106K	1.6 x 0.8 x 0.8 (2)
Murata	22 μ F, 6.3 V	GRM21BR60J226ME39	2 x 1.25 x 1.25
TDK	22 μ F, 6.3 V	C2012X5R0J226M	2 x 1.25 x 1.25
TDK	22 μ F, 10 V	C3216X5R1A226K	2 x 1.25 x 1.25
Murata	10 μ F, 10 V	GRM21BR71A106KE51L	2 x 1.25 x 1.25 (2)

Table 4. Sample of Recommended Inductors

Vendor	Value (μ H)	Part No.	DCR (m Ω)	I _{SAT} (A)	Dimensions L x W x H (mm)
Toko	1.2	DE2810C	55	1.7	2.8 x 2.8 x 1.0
Toko	1.5	DE2810C	60	1.5	2.8 x 2.8 x 1.0
Toko	1	MDT2520-CN	100	1.8	2.5 x 2 x 1.2
Murata	1	LQM2HP-G0	55	1.6	2.5 x 2 x 1
Murata	1.5	LQM2HP-G0	70	1.5	2.5 x 2 x 1
TDK	1.0	CPL2512T	90	1.5	2.5 x 1.5 x 1.2
TDK	1.5	CPL2512T	120	1.2	2.5 x 1.5 x 1.2
Coilcraft	1.0	LPS3010	85	1.7	3.0 x 3.0 x 0.9
Coilcraft	1.5	LPS3010	120	1.3	3.0 x 3.0 x 0.9

Output Capacitor Selection

The output capacitor selection determines the output voltage ripple, transient response and the loop dynamics of the ADP2503/ADP2504. The output voltage ripple for a given output capacitor is given by

$$\Delta V_{OUT, peak} (Buck) = \frac{V_{OUT} \times (V_{IN} - V_{OUT})}{V_{IN} \times 8 \times L \times (f_{OSC})^2 \times C_{OUT}}$$

$$\Delta V_{OUT, peak} (Boost) = \frac{I_{LOAD} \times (V_{OUT} - V_{IN})}{C_{OUT} \times V_{OUT} \times f_{OSC}}$$

If the ADP2503/ADP2504 are operating in buck mode, the worst-case voltage ripple occurs for the highest input voltage, V_{IN} . If the ADP2503/ADP2504 are operating in boost mode, the worst-case voltage ripple occurs for the lowest input voltage, V_{IN} .

The maximum voltage overshoot, or undershoot is inversely proportional to the value of the output capacitor. To ensure stability and excellent transient response, it is recommended to use a minimum of 22 μ F X5R 6.3 V or 2 x 10 μ F X5R 6.3 V capacitors at the output. The effective capacitance (includes temperature, dc bias effects) needed for stability is 14 μ F.

Input Capacitor Selection

The ADP2503/ADP2504 require an input capacitor to filter noise on the VIN pin, and provide the transient currents while maintaining constant input and output voltage. A 10 μF X5R/X7R ceramic capacitor rated for 6.3 V is the minimum recommended input capacitor. Increased input capacitance reduces the amplitude of the switching frequency ripple on the battery. Because of the dc bias characteristics of ceramic capacitors, a 0603, 6.3 V X5R/X7R, 10 μF ceramic capacitor is preferable.

Table 6. Recommended Input Capacitors

Vendor	Value	Part No.	Dimensions L x W x H (mm)
Murata	10 μF , 6.3 V	GRM188R60J106ME47	1.6 x 0.8 x 0.8
TDK	10 μF , 6.3 V	C1608JB0J106K	1.6 x 0.8 x 0.8

EEPW 电子产品世界
.com.cn

PCB LAYOUT GUIDELINES

Poor layout can affect ADP2503/ADP2504 performance, causing electromagnetic interference (EMI) and electromagnetic compatibility (EMC) performance, ground bounce, and voltage losses. Poor layout can also affect regulation and stability. A good layout is implemented using the following rules:

- Place the inductor, input capacitor, and output capacitor close to the IC using short tracks. These components carry high switching frequencies and large tracks act like antennas.
- Route the output voltage path away from the inductor and SW node to minimize noise and magnetic interference.
- Maximize the size of ground metal on the component side to help with thermal dissipation.
- Use a ground plane with several vias connecting to the component side ground to further reduce noise interference on sensitive circuit nodes.

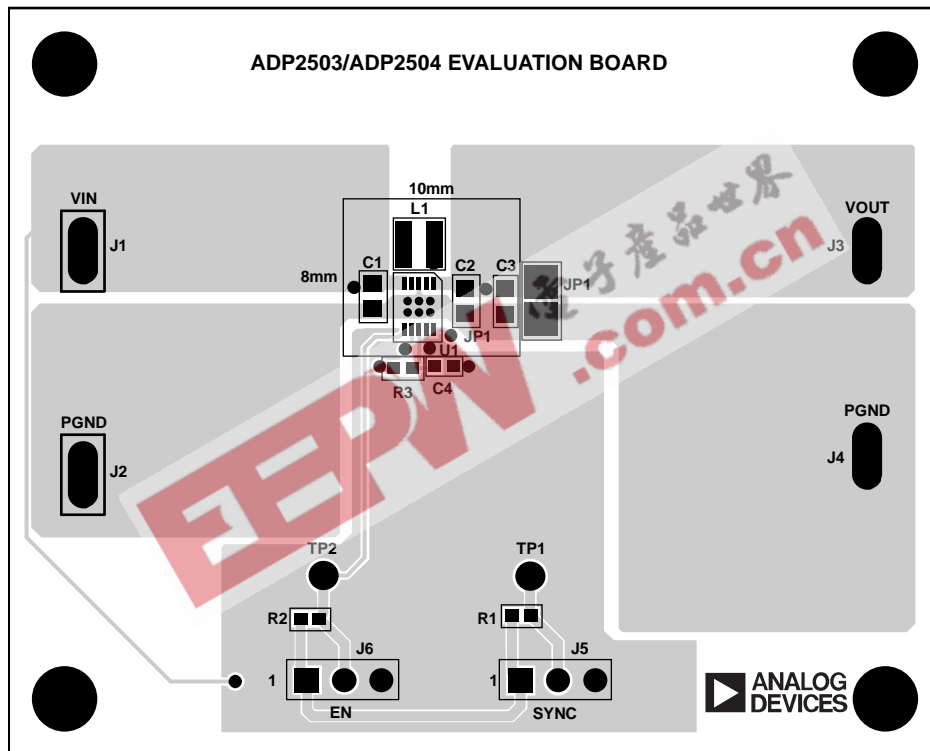

Figure 28. ADP2503/ADP2504 Evaluation Board

OUTLINE DIMENSIONS

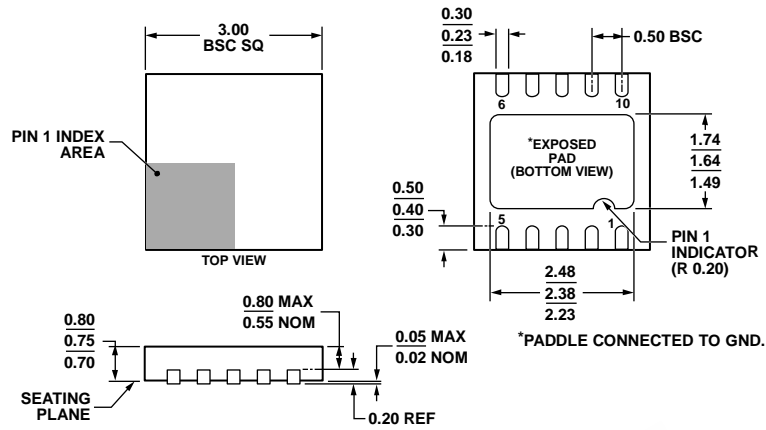

Figure 298. 10-Lead Lead Frame Chip Scale Package [LFCSP_WD]
 3 mm × 3 mm Body, Very Very Thin, Dual Lead
 (CP-10-9)
 Dimensions shown in millimeters

060408-B

ORDERING GUIDE

Model	Voltage	Maximum Current	Temperature Range	Package Description	Package Option	Branding
ADP2503ACPZ-2.8-R7 ¹	2.8 V	0.6 A	-40°C to +85°C	10-Lead Lead Frame Chip Scale Package [LFCSP_WD]	CP-10-9	L9Y
ADP2503ACPZ-3.3-R7 ¹	3.3 V	0.6 A	-40°C to +85°C	10-Lead Lead Frame Chip Scale Package [LFCSP_WD]	CP-10-9	L9Z
ADP2503ACPZ-3.5-R7 ¹	3.5 V	0.6 A	-40°C to +85°C	10-Lead Lead Frame Chip Scale Package [LFCSP_WD]	CP-10-9	LAP
ADP2503ACPZ-4.2-R7 ¹	4.2 V	0.6 A	-40°C to +85°C	10-Lead Lead Frame Chip Scale Package [LFCSP_WD]	CP-10-9	LA0
ADP2503ACPZ-4.5-R7 ¹	4.5 V	0.6 A	-40°C to +85°C	10-Lead Lead Frame Chip Scale Package [LFCSP_WD]	CP-10-9	LA1
ADP2503ACPZ-5.0-R7 ¹	5.0 V	0.6 A	-40°C to +85°C	10-Lead Lead Frame Chip Scale Package [LFCSP_WD]	CP-10-9	LA2
ADP2504ACPZ-2.8-R7 ¹	2.8 V	1 A	-40°C to +85°C	10-Lead Lead Frame Chip Scale Package [LFCSP_WD]	CP-10-9	L9T
ADP2504ACPZ-3.3-R7 ¹	3.3 V	1 A	-40°C to +85°C	10-Lead Lead Frame Chip Scale Package [LFCSP_WD]	CP-10-9	L85
ADP2504ACPZ-3.5-R7 ¹	3.5 V	1 A	-40°C to +85°C	10-Lead Lead Frame Chip Scale Package [LFCSP_WD]	CP-10-9	LAN
ADP2504ACPZ-4.2-R7 ¹	4.2 V	1 A	-40°C to +85°C	10-Lead Lead Frame Chip Scale Package [LFCSP_WD]	CP-10-9	L9U
ADP2504ACPZ-4.5-R7 ¹	4.5 V	1 A	-40°C to +85°C	10-Lead Lead Frame Chip Scale Package [LFCSP_WD]	CP-10-9	L9V
ADP2504ACPZ-5.0-R7 ¹	5.0 V	1 A	-40°C to +85°C	10-Lead Lead Frame Chip Scale Package [LFCSP_WD]	CP-10-9	L9W

¹ Z = RoHS Compliant Part.

NOTES

EEPW 电子产品世界
.com.cn