



5.4W DC-DC CONVERTERS

DAC2800S SERIES

4707 Dey Road Liverpool, N.Y. 13088

(315) 701-6751

FEATURES:

- Wave Solderable Package
- All Ceramic Capacitors
- Surface Mount Magnetics
- MIL STD 461C CR03 (DC-DC Converters)
- 80 Volt Input Transient Tolerant
- Wide Supply Range - 11V to 50V
- High Isolation - 500V
- High Power Density - 15 W/in³
- Output Voltage Adjustment - Standard
- Remote Shutdown
- Operates to 11V Input at 5W
- Available with 12V or 15V Outputs
- See DHC2800S Series for 3.3V and 5.0V Versions
- Available Soon to DSCC SMD 5962-93093, 5962-94631, 5962-93094 and 5962-94630
- Replaces Interpoint MSA2812S, MSA2815S and IR ASA2812S, ASA2815S

MIL-PRF-38534 CERTIFIED

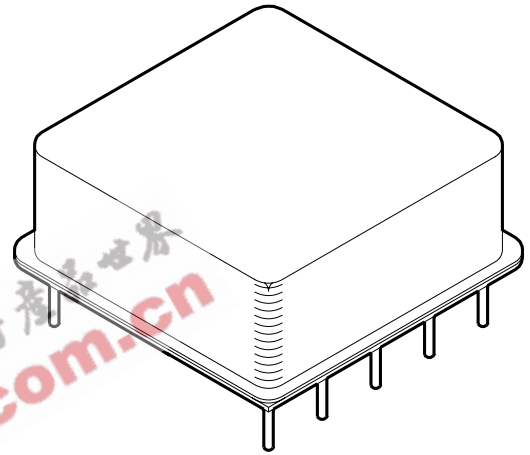

DESCRIPTION:

The DAC2812S and DAC2815S DC-DC converters are higher output voltage companion devices to MSK's DHC types. The DAC's provide the ruggedness, reliability and features required to meet the advanced design challenges of today's hi-rel market. This has been accomplished while retaining a power density of 15 W/in³ and 375 mW/gram of power/package performance. The use of advanced substrate and reflow soldering techniques during construction results in a rugged, cost-effective and completely solderable package.

The DAC2800S hybrid converter series utilizes all ceramic capacitors, surface mount magnetics, and ultrasonically bonded wires to provide reliable operation at all operating temperatures.

The DAC2800S series standard features include output fault monitoring and/or turn on voltage point programming via the shutdown pin. All three functions may be implemented simultaneously with a minimum of external components. An output voltage adjustment / load compensation pin which adjusts outputs simultaneously is also standard.

Fault tolerant design protects these converters from most external circuit faults. The + output and output adjust pins will withstand +25 V while the shutdown pin will withstand +50 V, protecting the converters from a variety of system or board faults; e.g. solder bridges etc. Unique load fault protection circuitry allows this converter to pull up loads having difficult static load line characteristics and allows short term load excursions significantly beyond ratings in most applications.

A transformer isolated flyback converter topology operating at a switching frequency of 400 kHz allows operation over a wide input voltage range. Internal filtering of outputs eliminates the need for external capacitors in many applications.

The 8-pin package is hermetically sealed and isolated from the internal circuits. Heat sinking is recommended for full power operation at elevated ambient temperatures.

EQUIVALENT SCHEMATIC

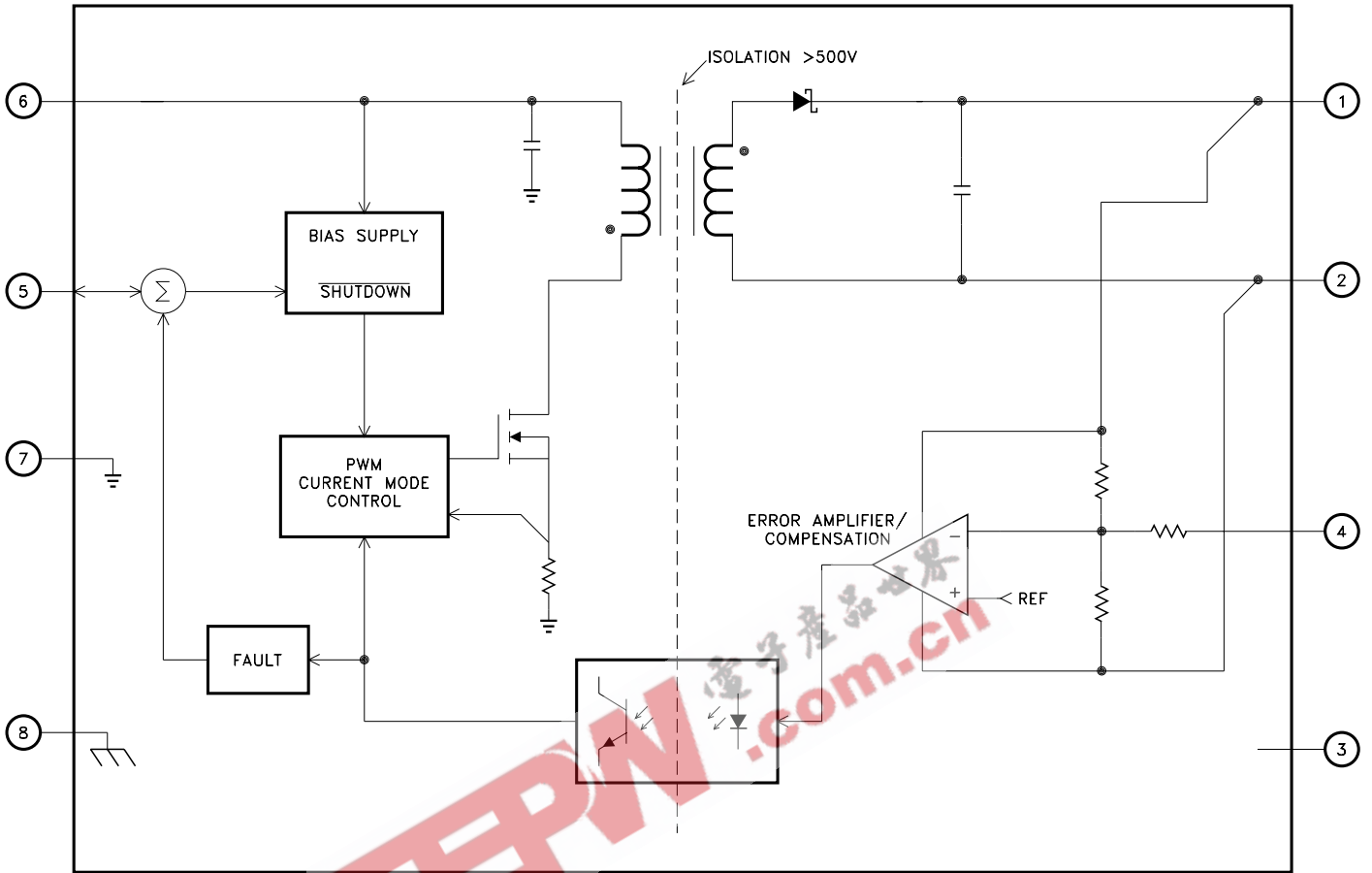

TYPICAL APPLICATIONS

- Isolated Step Down Power Supply
- Microprocessor Power Source
- Low Voltage Subsystem Power Source

PIN-OUT INFORMATION

1 + Output	8 Case
2 -Output	7 -Input
3 NC	6 +Input
4 Adjust/Comp	
5 Shutdown Plus	

ABSOLUTE MAXIMUM RATINGS

V_{IN}	Input Voltage (pin 7 to pin 6)	+50V
V_{INT}	Input Transient (pin 7 to pin 6 @ 50ms)	80V
I_{OUT}	Output Current	
	DAC2812S	450mA
	DAC2815S	360mA
T_C	Case Temperature Range	
	DAC2800S H/E	-55°C to +125°C
	DAC2800S	-40°C to +85°C

T_{ST}	Storage Temperature Range	-65°C to +150°C
T_{LD}	Lead Temperature Range	
	(10 Seconds)	300°C
P_D	Power Dissipation	See Efficiency Curve
T_J	Junction Temperature	150°C
θ_{JC}	Thermal Resistance	
	(Switches)	5.0°C/W

NOTE: Continuous operation at or above the absolute maximum ratings may adversely effect the performance and/or life of the device.

ELECTRICAL SPECIFICATIONS

DAC2812S

Parameter	Test Conditions ①	Group A Subgroup	DAC2812S H/E			DAC2812S			Units
			Min.	Typ.	Max.	Min.	Typ.	Max.	
Output Voltage		1	11.9	12.0	12.1	11.85	12.0	12.15	VDC
		2,3	11.76	-	12.24	-	-	-	VDC
Output Current ②	11V ≤ VIN ≤ 50V	1	417	-	-	417	-	-	mA
		2,3	417	-	-	-	-	-	mA
	16V ≤ VIN ≤ 40V	1	450	-	-	450	-	-	mA
		2,3	450	-	-	-	-	-	mA
Output Voltage Ripple	BW = 10KHz to 2MHz	1	-	15	60	-	15	60	mVrms
		2,3	-	-	100	-	-	-	mVrms
Input Current Ripple ②	BW = 10KHz to 2MHz LIN = 2μH	1	-	76	125	-	76	125	mAp-p
		2,3	-	-	200	-	-	-	mAp-p
Line Regulation	VIN = 16, 28 and 40 VDC IOUT = 0, 208 and 417mA	1	-	±5	±25	-	±5	±30	mV
		2,3	-	-	±50	-	-	-	mV
Load Regulation	VIN = 16, 28 and 40 VDC IOUT = 0, 208 and 417mA	1	-	±5	±25	-	±5	±30	mV
		2,3	-	-	±50	-	-	-	mV
Efficiency		1	62	67	-	62	67	-	%
		2,3	60	-	-	-	-	-	%
Step Load Response	IOUT = 208mA to/from 417mA Transition Time = 30μS	4	-	±350	±500	-	±350	±500	mV
		5,6	-	-	±700	-	-	-	mV
Step Load Recovery	IOUT = 208mA to/from 417mA Transition Time = 30μS	4	-	80	200	-	80	200	μS
		5,6	-	-	200	-	-	-	μS
Step Line Response ②	VIN = 16V to/from 40V Transition Time = 30μS	4	-	±200	±500	-	±200	±500	mV
		5,6	-	-	±500	-	-	-	mV
Step Line Recovery ②	VIN = 16V to/from 40V Transition Time = 30μS	4	-	90	200	-	90	200	μS
		5,6	-	-	200	-	-	-	μS
Start Up Overshoot		4	-	0	200	-	0	200	mV
		5,6	-	-	200	-	-	-	mV
Start Up Delay		4	-	40	60	-	40	60	mS
		5,6	-	-	60	-	-	-	mS
Shutdown Delay ②		4	-	250	500	-	250	500	μS
		5,6	-	-	500	-	-	-	μS
Shutdown Recovery ②		-	-	40	60	-	40	60	mS
Input Voltage Range ②	POUT = 5.4W MAX.	1,2,3	16	-	40	16	-	40	V
	POUT = 5W MAX.	1,2,3	11	-	50	11	-	50	V
Quiescent Current	Enabled, IOUT = 0mA	1,2,3	-	35	50	-	35	50	mA
	Disabled IOUT = 0mA	1,2,3	-	1.25	2.5	-	1.25	2.5	mA
Capacitive Load ②	No Effect on DC Performance	1,2,3	-	-	300	-	-	300	μF
Isolation	Input to output or any pin to case @ 500V	1	100	-	-	100	-	-	MΩ
Short Circuit Current Limit ⑦		1	0.50	1.1	1.8	0.50	1.1	1.8	A
Switching Frequency		4	375	400	425	375	400	425	KHz
VOUT Adjustment Range	RPOT = 50KΩ	1	±10	-	-	±10	-	-	%

NOTES:

- ① +VIN = 28V, IOUT = 417mA, TA = TC = 25°C unless otherwise specified.
- ② Guaranteed by design but not tested. Typical parameters are representative of actual device performance but are for reference only.
- ③ Industrial grade and "E" suffix devices shall be tested to subgroups 1 and 4 unless otherwise specified.
- ④ Military grade devices ("H" suffix) shall be 100% tested to subgroups 1, 2, 3 and 4.
- ⑤ Subgroups 5 and 6 testing available upon request.
- ⑥ Subgroup 1, 4 TA = TC = +25°C
2, 5 TA = TC = +125°C
3, 6 TA = TC = -55°C
- ⑦ Device has internal shutdown feature that pulses the output with a low duty cycle during faults.
- ⑧ Consult DSCC SMD for electrical parameters for devices purchased as such.

ELECTRICAL SPECIFICATIONS

DAC2815S

Parameter	Test Conditions ①	Group A Subgroup	DAC2815S H/E			DAC2815S			Units
			Min.	Typ.	Max.	Min.	Typ.	Max.	
Output Voltage		1	14.90	15.00	15.10	14.85	12.0	15.15	VDC
		2,3	14.70	15.00	15.30	-	-	-	VDC
Output Current ②	11V ≤ VIN ≤ 50V	1	333	-	-	333	-	-	mA
		2,3	333	-	-	-	-	-	mA
	16V ≤ VIN ≤ 40V	1	360	-	-	360	-	-	mA
		2,3	360	-	-	-	-	-	mA
Output Voltage Ripple	BW = 10KHz to 2MHz	1	-	15	60	-	15	60	mVrms
		2,3	-	-	100	-	-	-	mVrms
Input Current Ripple ②	BW = 10KHz to 2MHz LIN = 2μH	1	-	76	125	-	76	125	mA _{p-p}
		2,3	-	-	200	-	-	-	mA _{p-p}
Line Regulation	VIN = 16,28 and 40VDC IOUT = 0,167 and 333mA	1	-	±5	±25	-	±5	±30	mV
		2,3	-	-	±50	-	-	-	mV
Load Regulation	VIN = 16,28 and 40VDC IOUT = 0,167 and 333mA	1	-	±5	±25	-	±5	±30	mV
		2,3	-	-	±50	-	-	-	mV
Efficiency		1	63	68	-	63	68	-	%
		2,3	61	-	-	-	-	-	%
Step Load Response	IOUT = 167mA to/from 333mA Transition Time = 30μS	4	-	±400	±600	-	±400	±600	mV
		5,6	-	-	±750	-	-	-	mV
Step Load Recovery	IOUT = 167mA to/from 333mA Transition Time = 30μS	4	-	100	200	-	100	200	μS
		5,6	-	-	200	-	-	-	μS
Step Line Response ②	VIN = 16V to/from 40V Transition Time = 30μS	4	-	±200	±500	-	±200	±500	mV
		5,6	-	-	±500	-	-	-	mV
Step Line Recovery ②	VIN = 16V to/from 40V Transition Time = 30μS	4	-	90	200	-	90	200	μS
		5,6	-	-	200	-	-	-	μS
Start Up Overshoot		4	-	0	200	-	0	200	mV
		5,6	-	0	200	-	-	-	mV
Start Up Delay		4	-	40	60	-	40	60	mS
		5,6	-	-	60	-	-	-	mS
Shutdown Delay ②		4	-	250	500	-	250	500	μS
		5,6	-	-	500	-	-	-	μS
Shutdown Recovery ②		-	-	40	60	-	40	60	mS
Input Voltage Range ②	POUT = 5.4W MAX.	1,2,3	16	-	40	16	-	40	V
	POUT = 5W MAX.	1,2,3	11	-	50	11	-	50	V
Quiescent Current	Enabled, IOUT = 0mA	1,2,3	-	35	50	-	35	50	mA
	Disabled IOUT = 0mA	1,2,3	-	1.25	2.5	-	1.25	2.5	mA
Capacitive Load ②	No Effect on DC Performance	1,2,3	-	-	300	-	-	300	μF
Isolation	Input to output or any pin to case @ 500V	1	100	-	-	100	-	-	MΩ
Short Circuit Current Limit ⑦		1	0.40	0.95	1.5	0.40	0.95	1.5	A
Switching Frequency		4	375	400	425	375	400	425	KHz
VOUT Adjustment Range	RPOT = 50KΩ	1	±10	-	-	±10	-	-	%

NOTES:

- ① +VIN = 28V, IOUT = 333mA, TA = TC = 25°C unless otherwise specified.
- ② Guaranteed by design but not tested. Typical parameters are representative of actual device performance but are for reference only.
- ③ Industrial grade and "E" suffix devices shall be tested to subgroups 1 and 4 unless otherwise specified.
- ④ Military grade devices ("H" suffix) shall be 100% tested to subgroups 1, 2, 3 and 4.
- ⑤ Subgroups 5 and 6 testing available upon request.
- ⑥ Subgroup 1, 4 TA = TC = +25°C
2, 5 TA = TC = +125°C
3, 6 TA = TC = -55°C
- ⑦ Device has internal shutdown feature that pulses the output with a low duty cycle during faults.
- ⑧ Consult DSCC SMD for electrical parameters for devices purchased as such.

APPLICATION NOTES

POWER SUPPLIES

The output voltage of the DAC2812S and DAC2815S may be adjusted from 90% to 110% of nominal value by the use of a 150KΩ potentiometer as shown. Adjustment beyond this range is possible however certain characteristics of the converter such as but not limited to input voltage range, efficiency, ripple and temperature performance will change. Characterization by the user is recommended in such applications.

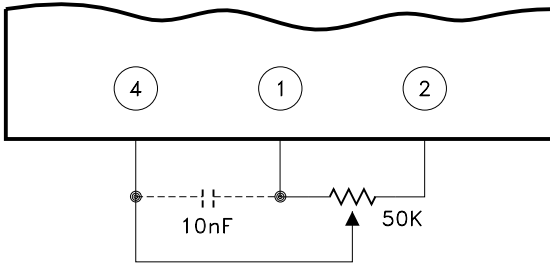

Adjust/comp (pin 4) may be driven by external circuitry referenced to pin 2 (-output) if desired. Grounding pin 4 causes voltage to increase (25% typically) while driving pin 4 above 1.3V causes output voltage to decrease. Pin 4 may be driven negative without damage, however the resultant increase in converter output voltage should be considered. Pin 4 may be driven through 10KΩ or more if connection of the comp function is also required.

The comp function of pin 4 allows load transient response to be tailored to suit specific application requirements. This feature may be utilized by connecting a 10 or less nF capacitor between pins 4 and 1.

Note: The DAC2812S and DAC2815S use pin 4 while the DHC2803S and DHC2805S use pin 3.

SHUTDOWN PLUS

Pin 5 is used for remote shutdown, output fault detection, and/or setting the input voltage point at which the converter will turn on as shown in the typical application diagram. No connection to pin 5 is necessary for normal operation of the converter. Pin 5 is referenced to the pin 7 (-input).

Shutdown may be implemented by simply connecting pin 5 to an open collector logic output or switch rated at 2.5mA, 25Vdc or higher.

Input voltage turn on point is programmed with a single resistor from pin 5 to 7. An input turn on/off hysteresis (typically 3.5% of V_{in}) will be observed. This should be considered when making or verifying set point adjustment. The value of the setpoint resistor may be determined by the following:

$$R = \frac{210 \cdot 10^3}{E_{TO} - 9.5} \quad (\pm 10\% \text{ accuracy at } 25^\circ\text{C})$$

Set point temperature coefficient is typically +400ppm/°C.

Output fault monitoring is accomplished by observing pin 5 with a high impedance monitoring circuit. Pin 5 voltage drops from over 10V to below 1V when a load fault causes the converters fault protection circuitry to activate. It will remain low for at least 100mS and return high. If the load fault is still present pin 5 will return low and the cycle will repeat. A resistor >400KΩ from pin 5 to 7 provides pull down for pin 5 if there is no input setpoint programming resistor already in place.

LOAD FAULT RESPONSE

The MSK families of DC-DC converters share load fault philosophies. Load fault conditions include short-circuit and severe overload conditions. The DAC2800S converter series responds to load faults by turning off all power conversion circuits for 250mS and then attempting to restart for 10mS (typical). The net "on" duty factor during a fault is very low resulting in low converter dissipation and immunity from overheating at 125°C. Current beyond rated can flow into the load at startup time. This allows the converter to bring up capacitive and other difficult load types more reliably than competing converters.

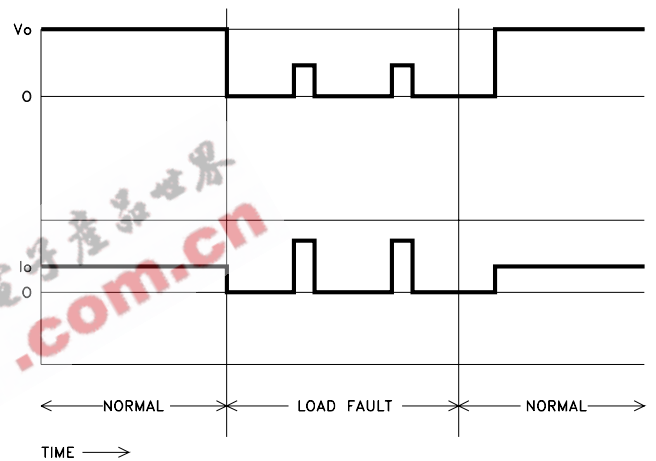

TYPICAL APPLICATION CIRCUIT

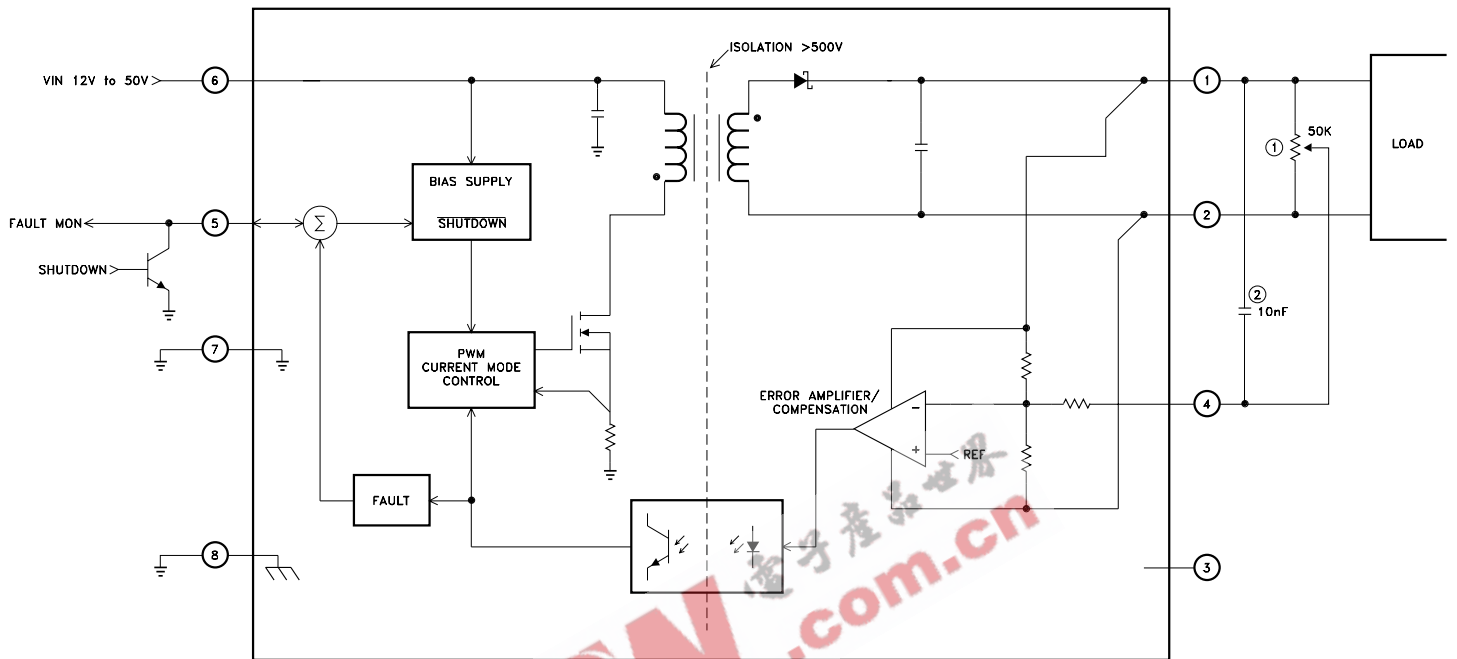

NOTES:

1. OPTIONAL OUTPUT ADJUSTMENT RESISTOR. SEE PARAGRAPH TITLED POWER SUPPLIES.
2. OPTIONAL COMPENSATION CAPACITOR. SEE PARAGRAPH TITLED POWER SUPPLIES.

TYPICAL PERFORMANCE CURVES

DAC2812S

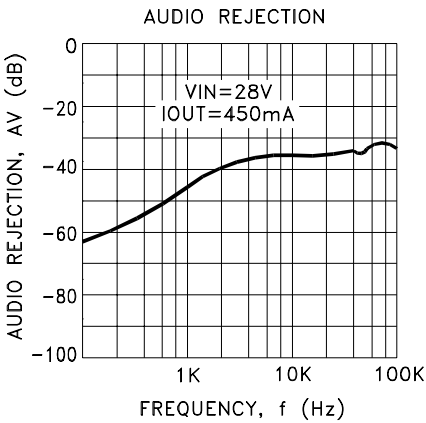
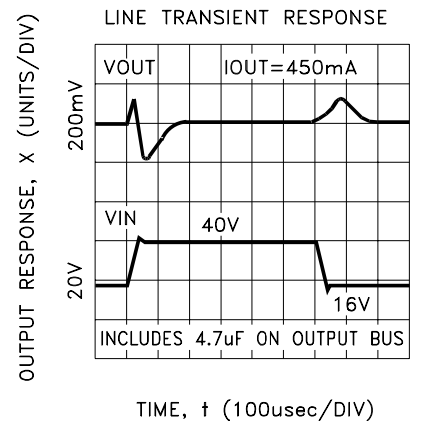
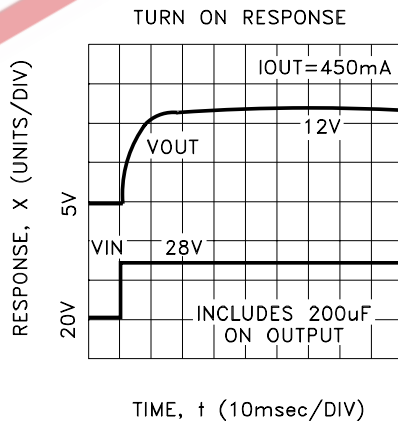
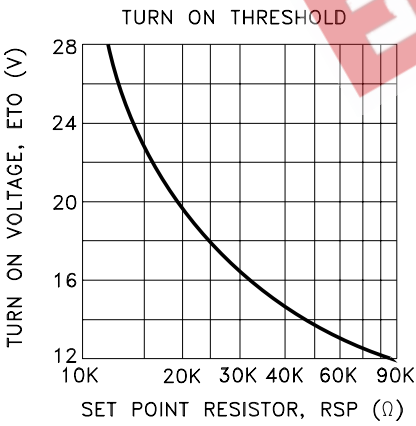
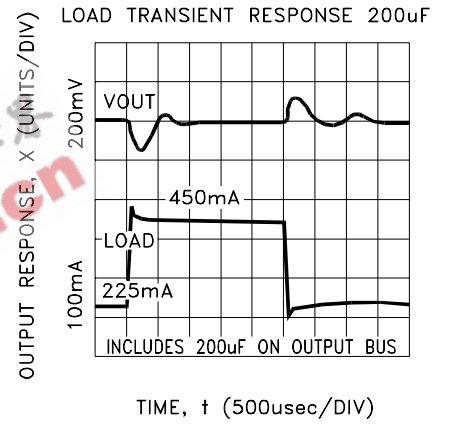
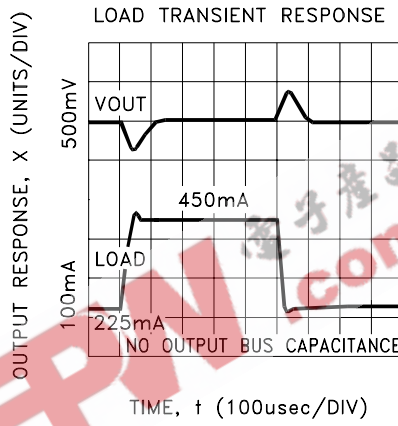
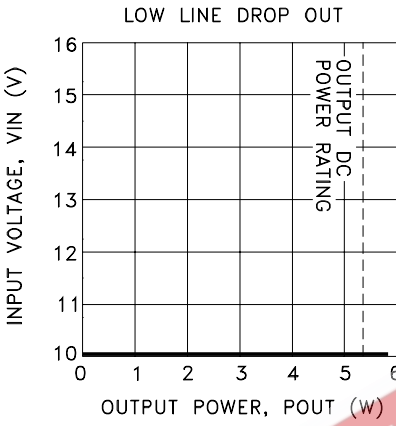
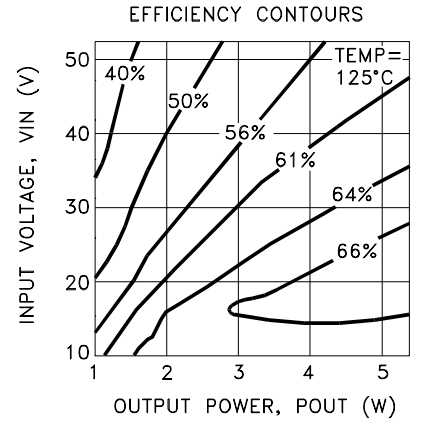
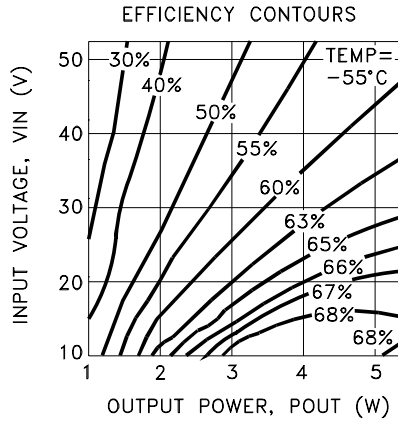
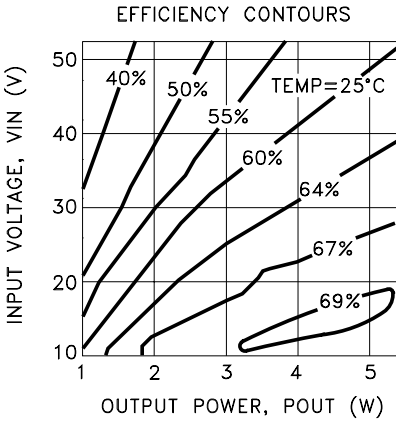

TYPICAL PERFORMANCE CURVES

DAC2815S

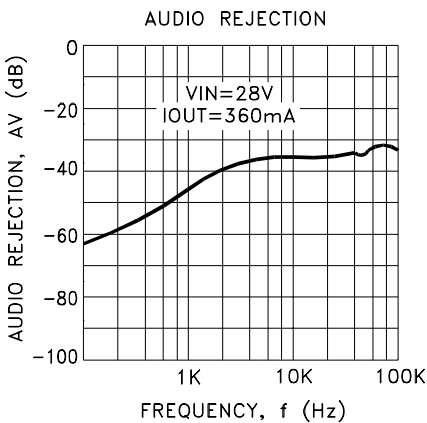
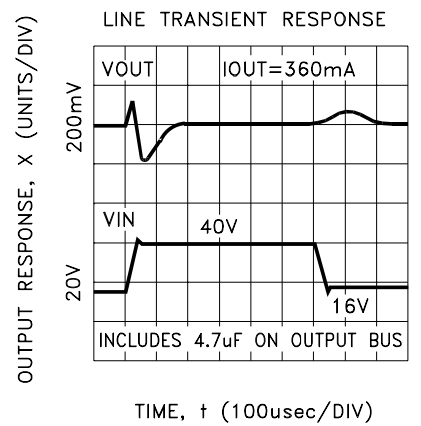
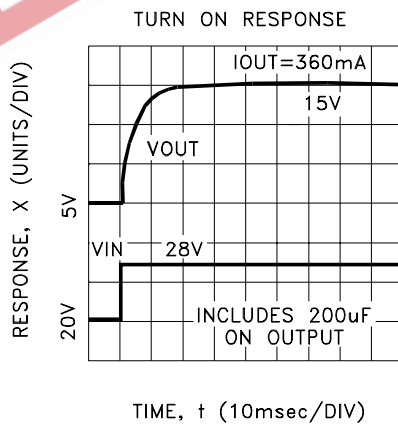
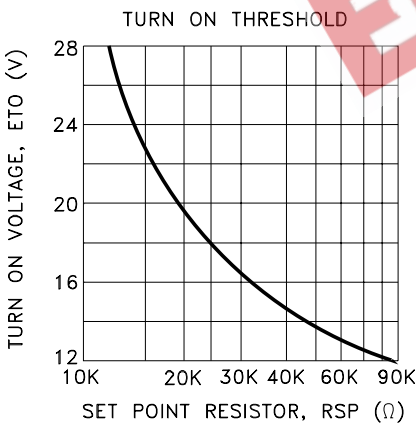
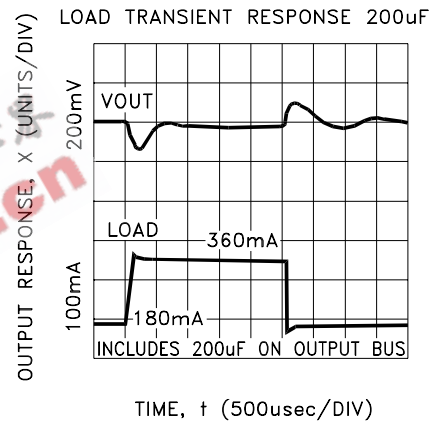
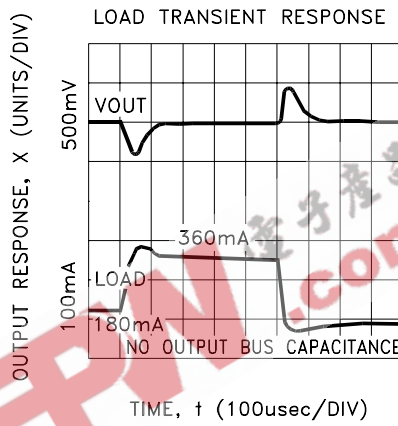
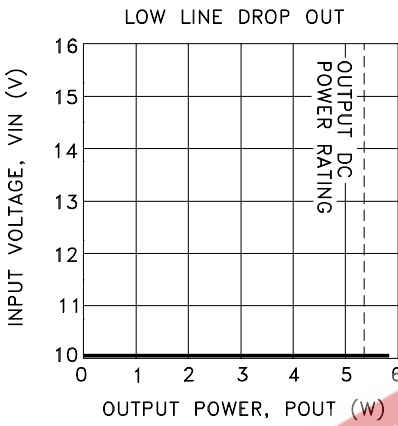
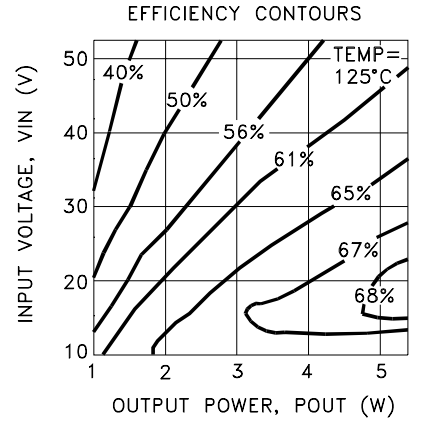
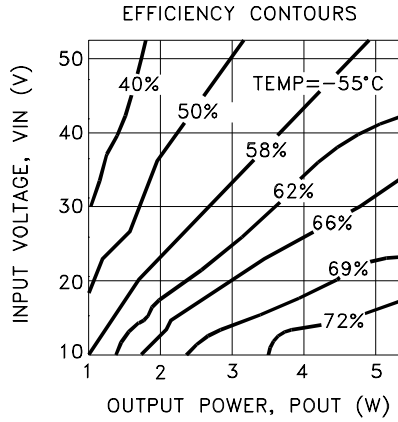
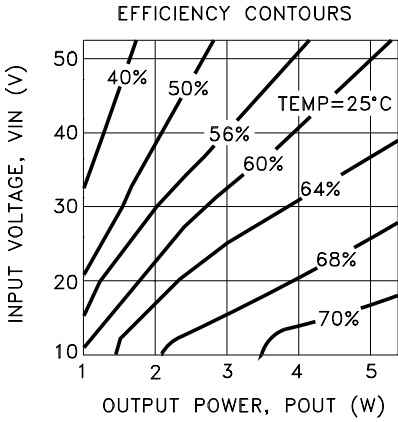

MECHANICAL SPECIFICATIONS

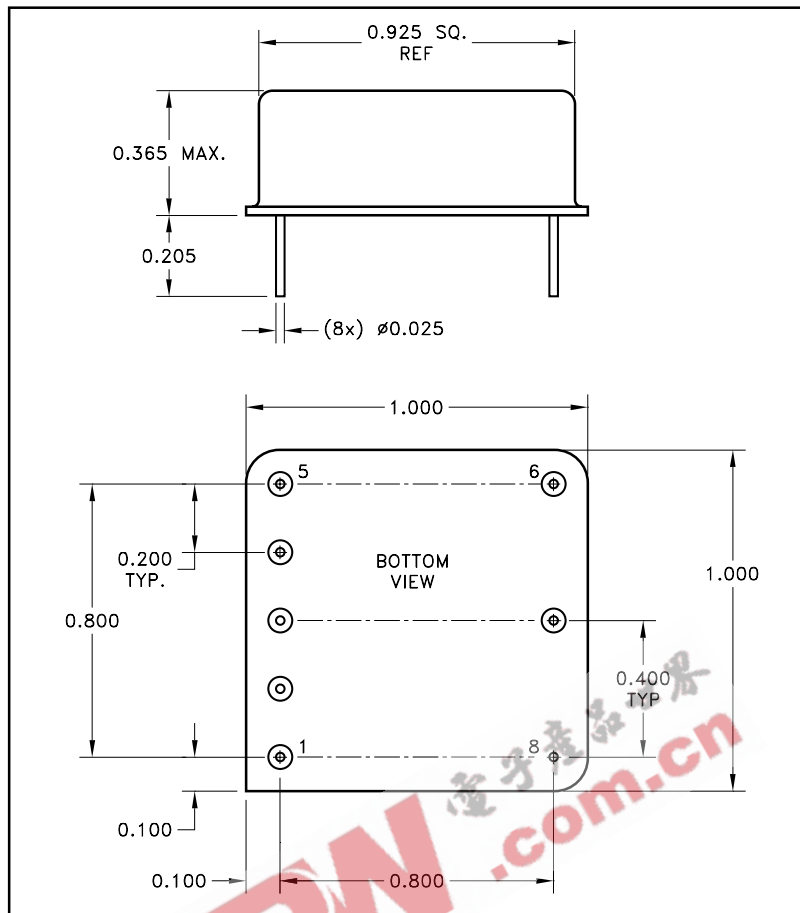

NOTE: ALL DIMENSIONS ARE ± 0.010 INCHES UNLESS OTHERWISE LABELED.
ESD Triangle indicates Pin 1.

ORDERING INFORMATION

Part Number	Screening Level	Output Voltage
DAC2812S	Industrial	12V
DAC2812SE	Extended Reliability	
DAC2812SH	MIL-PRF-38534 Class H	
5962-93093	DSCC-SMD	
5962-94631	DSCC-SMD	
DAC2815S	Industrial	15V
DAC2815SE	Extended Reliability	
DAC2815SH	MIL-PRF-38534 Class H	
5962-93094	DSCC-SMD	
5962-94630	DSCC-SMD	

M.S. Kennedy Corp.
4707 Dey Road, Liverpool, New York 13088
Phone (315) 701-6751
FAX (315) 701-6572
www.mskennedy.com

The information contained herein is believed to be accurate at the time of printing. MSK reserves the right to make changes to its products or specifications without notice, however, and assumes no liability for the use of its products. Please visit our website for the most recent revision of this datasheet.