

Solid-state Relay G3NE

Compact, Low-cost, SSR Switching 5 to 20 A

- Wide load voltage range: 75 to 264 VAC. Both 100-V and 200-V loads can be handled with the same model.
- Dedicated, compact aluminum PCB and power elements used.
- Built-in varistor effectively absorbs external surges.
- Quick-connect #110 input terminals and #250 output connections.
- UL, CSA, and IEC/EN (TÜV) approval obtained for “-US” models.



Ordering Information

List of Models

Isolation	Zero cross function	Indicator	Rated output load	Rated input voltage	Model
Phototriac	Yes	No	5 A at 100 to 240 VAC	5, 12, 24 VDC	G3NE-205T G3NE-205T-US G3NE-205T-2-US
			10 A at 100 to 240 VAC		G3NE-210T G3NE-210T-US G3NE-210T-2-US
			20 A at 100 to 240 VAC		G3NE-220T G3NE-220T-US G3NE-220T-2-US
	No		5 A at 100 to 240 VAC		G3NE-205TL G3NE-205TL-US G3NE-205TL-2-US
			10 A at 100 to 240 VAC		G3NE-210TL G3NE-210TL-US G3NE-210TL-2-US
			20 A at 100 to 240 VAC		G3NE-220TL G3NE-220TL-US G3NE-220TL-2-US

Note: When ordering, specify the input voltage.

Accessories (Order Separately)

Heat Sinks

The following heat sinks are thin and can be DIN-track mounted. See *Dimensions* for details.

Model	Applicable SSR
Y92B-N50	G3NE-205T(L)(-2)(-US)/-210T(L)(-2)(-US)
Y92B-N100	G3NE-220T(L)(-2)(-US)

Specifications

Ratings

Input

Rated voltage	Operating voltage	Voltage level		Input impedance	
		Must operate	Must release	With zero cross function	Without zero cross function
5 VDC	4 to 6 VDC	4 VDC max.	1 VDC min.	250 Ω±20%	300 Ω±20%
12 VDC	9.6 to 14.4 VDC	9.6 VDC max.		600 Ω±20%	800 Ω±20%
24 VDC	19.2 to 28.8 VDC	19.2 VDC max.		1.6 kΩ±20%	

Note: Each model has 5-VDC, 12-VDC, and 24-VDC input versions.

Output

Model	Applicable load				
	Rated load voltage	Load voltage range	Load current (See note 1.)		Inrush current
			With heat sink	Without heat sink	
G3NE-205T(L)-(-2)(US)	100 to 240 VAC	75 to 264 VAC	0.1 to 5 A	0.1 to 5 A	60 A (60 Hz, 1 cycle)
G3NE-210T(L)-(-2)(US)			0.1 to 10 A (See note 2.)	0.1 to 5 A	150 A (60 Hz, 1 cycle)
G3NE-220T(L)-(-2)(US)			0.1 to 20 A (See note 2.)	0.1 to 5 A	220 A (60 Hz, 1 cycle)

Note: 1. The load current varies depending on the ambient temperature. Refer to *Load Current vs. Ambient Temperature* under *Engineering Data* for details.

2. These values apply when using a dedicated radiator or a radiation plate of specified size.

■ Characteristics

Item	G3NE-2□□T(-2)(US)	G3NE-2□□TL(-2)(US)
Operate time	1/2 of load power source cycle + 1 ms max.	1 ms max.
Release time	1/2 of load power source cycle + 1 ms max.	
Output ON voltage drop	1.6 V (RMS) max.	
Leakage current	2 mA max. (at 100 VAC) 5 mA max. (at 200 VAC)	
Insulation resistance	100 MΩ min. (at 500 VDC)	
Dielectric strength	2,000 VAC, 50/60 Hz for 1 min	
Vibration resistance	Destruction: 10 to 55 to 10 Hz, 0.75-mm single amplitude (1.5-mm double amplitude)	
Shock resistance	Destruction: 1,000 m/s ²	
Ambient temperature	Operating: -30°C to 80°C (with no icing or condensation) Storage: -30°C to 100°C (with no icing or condensation)	
Ambient humidity	Operating: 45% to 85%	
Approved standards (only for -US models)	UL508 File No. E64562/CSA C22.2 (No.0, No.14) File No. LR35535 TÜV R9051064 (VDE0435) (EN60950)	
Weight	Approx. 37 g	

Engineering Data

Load Current vs. Ambient Temperature

G3NE-205T(L)-(-2)(US)

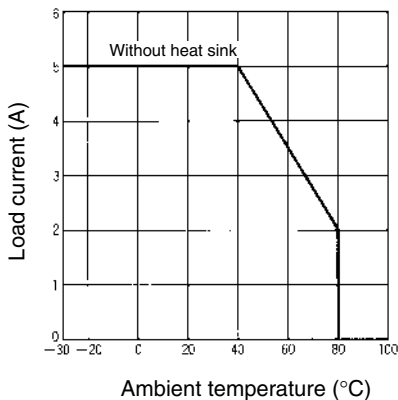

G3NE-210T(L)-(-2)(US)

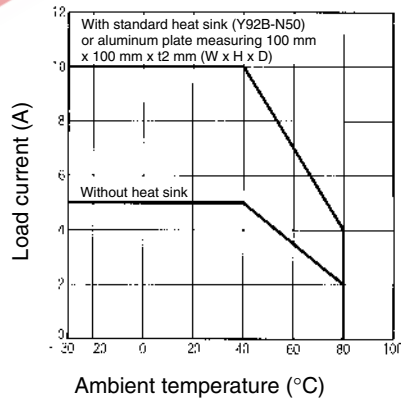

G3NE-220T(L)-(-2)(US)

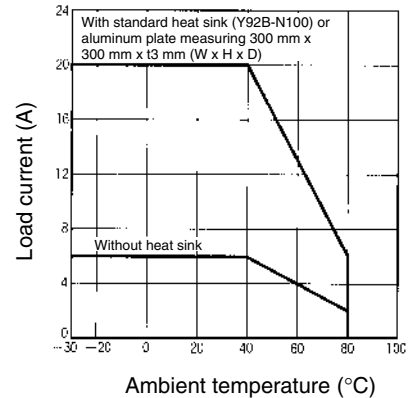

Inrush Current Resistivity: Non-repetitive

Note: Keep the inrush current to half the rated value if it occurs repetitively.

G3NE-205T(L)-(-2)(US)

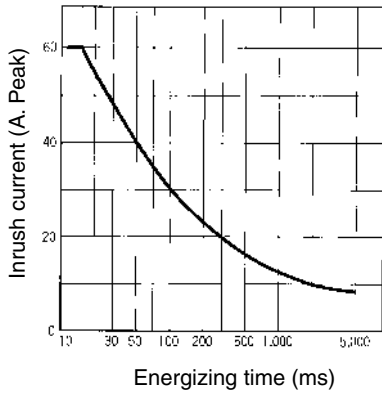

G3NE-210T(L)-(-2)(US)

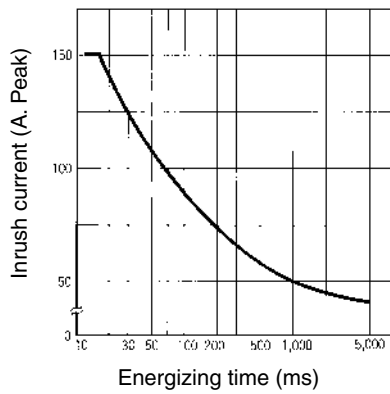

G3NE-220T(L)-(-2)(US)

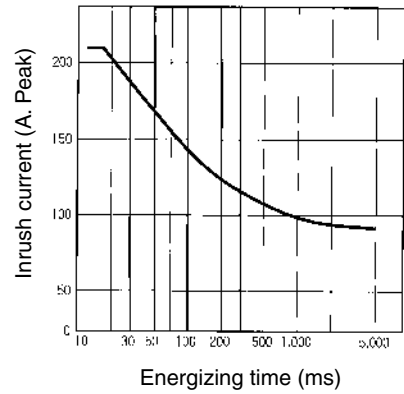

Dimensions

Note: All units are in millimeters unless otherwise indicated.

G3NE-205T(L)/210T(L)/220T(L)-(-2)(US)

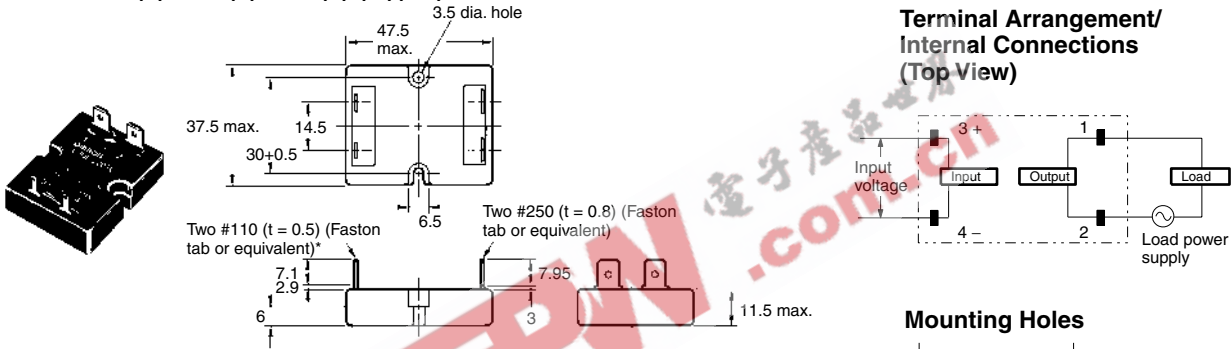

* G3NE-2□□T(L)-2-US: Two, #187 (t=0.5) (Faston tab or equivalent)

Heat Sink
Y92B-N50

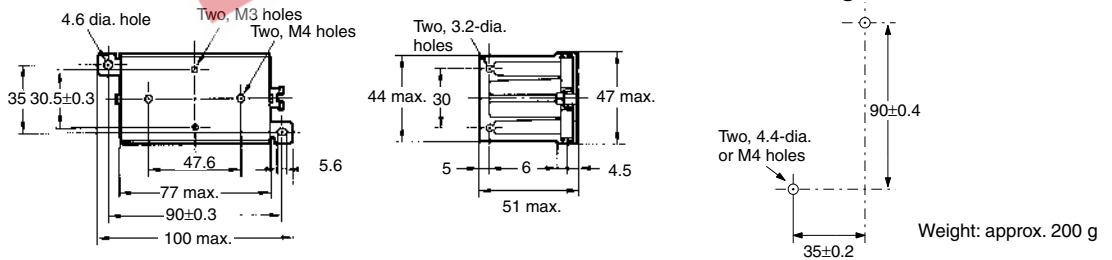

Y92B-N100

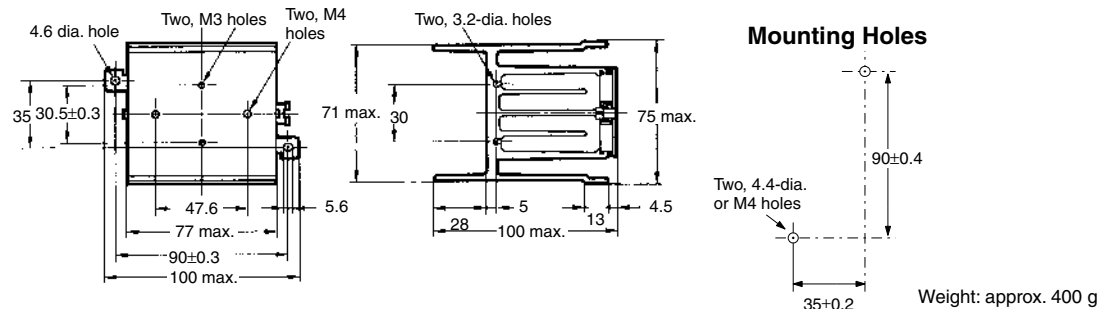

Precautions

Refer to the *Technical Information for SSRs* (Cat. No. J137) for general precautions.

■ Correct Use

Do not apply excessive force to the terminals. Exercise care when pulling or inserting the terminal clips for the Quick Connector (QC).

When attaching a heat sink to the G3NE, in order to facilitate heat dissipation, apply heat conductive grease on the heat sink. Tighten the mounting screws of the heat sink with a torque of 0.59 to 0.98 N·m.

EEPW 电子产品世界
.com.cn

ALL DIMENSIONS SHOWN ARE IN MILLIMETERS.

To convert millimeters into inches, multiply by 0.03937. To convert grams into ounces, multiply by 0.03527.

Cat. No. K062-E1-03

In the interest of product improvement, specifications are subject to change without notice.