



SERIES
FCB-205

Tyco Electronics Mid-Range Military/Aerospace Relays

5 AMPERES, DPDT

- HERMETICALLY SEALED
- ALL WELDED CONSTRUCTION
- BALANCED FORCE
- PERMANENT MAGNET DRIVE
- CONTACTS RATED LOW LEVEL
- TO 5 AMPS 28 VDC AND 115/200 VAC
400 Hz , 3 PHASE.
- WEIGHT .54 OUNCES MAX. (15.4 GRAMS)

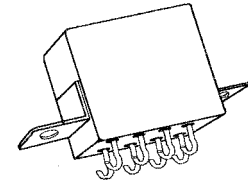
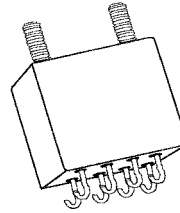
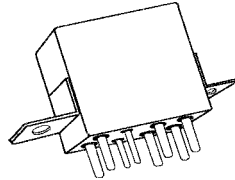

The Series FCB-205 relay is a polarized single-side stable design, where the flux from a permanent magnet provides the armature holding force in the deactivated state, and its flux path is switched and combined with the coil flux in the operated state. This results in appreciably increased contact pressure in both states over that of a spring return nonpolar design. We also manufacture other forms of the FCB relay:

- FCB-405:** 5 AMP 4PDT RELAY
- FCB-310:** 10 AMP 3PDT RELAY

CONTACT RATING-AMPERES

Ratings Are Continuous Duty

TYPE OF LOAD	LIFE (MIN.) CYCLES X 10 ³	28 VDC	115VAC 400Hz	115/200VAC 400 Hz, 3 ϕ
Resistive	100	5	5	5
Inductive	20	3	5	5
Motor	100	2	3	3
Lamp	100	1	1	1
* 60 Hz LOADS RATED FOR 10,000 OPERATIONS				

Low Level Switching Capability: With contacts operating a load of 10 to 50 microamperes at 10 to 50 millivolts, the contact resistance miss detection level shall be 100 ohms max. Cycling rate is 1 to 12 per second, for 100,000 operations.

OVERLOAD CURRENT 20 AMPS DC, 30AMPS 400Hz
RUPTURE CURRENT 25 AMPS DC, 40 AMPS 400Hz
CONTACT MAKE BOUNCE 1.0 MILLISECOND MAX. AT NOMINAL VOLTAGE
MAX. CONTACT DROP AT 5 AMPS: INITIAL 0.100 VOLTS.
END OF LIFE 0.125 VOLTS



Tyco Electronics Mid-Range Military/Aerospace Relays

5 AMPERES, DPDT

COIL DATA

COIL CODE	NOMINAL VOLTAGES	FREQ. Hz	DC RES. (B)	OVER TEMPERATURE RANGE		
				PICKUP OR BELOW VOLTS	DROPOUT OR ABOVE VOLTS	MUST HOLD VOLTAGE (C)
1	6	DC	31 Ω	4.5	0.3	2.5
2	12	DC	125 Ω	9.0	0.75	4.5
3	28	DC	500 Ω	18.0	1.5	7.0
4 (A)	28	DC	500 Ω	18.0	1.5	7.0
5	48	DC	1600 Ω	36.0	2.5	14.0

- A. CODE 4 COILS HAVE BACK EMF SUPPRESSION TO 42 VOLTS MAX.
 B. DC COIL RESISTANCE ± 10% AT 25°C;
 C. RELAY WILL STAY IN PICKUP STATE DOWN TO MUST HOLD VOLTAGES SHOWN.
 D. MAX. OVERVOLTAGE: 6 & 12 VDC COILS 120% OF NOMINAL; ALL OTHERS 110% OF NOMINAL.

NOTE: Only DC Coil Models are QPL Approved.

GENERAL SPECIFICATIONS

TEMPERATURE RATING:		-70°C TO + 125°C
ALTITUDE:		300,000 FEET
SHOCK:*	Z, Y, & X ENCLOSURES	200 g FOR 6 mS
	W & M ENCLOSURES (STUD MTG.)	100 g FOR 6 mS
	T ENCLOSURE (SOCKET MOUNTED IN TRACK)	50 g FOR 11 mS
VIBRATION, SINUSOIDAL:*	Z, Y, & X ENCLOSURES	0.12 DA 10 TO 70 Hz 30 g 70-3000Hz
	W & M ENCLOSURES	0.12 DA 10 TO 57 Hz 20 g 57-3000Hz
	T ENCLOSURE IN TRACK	0.06DA 10 TO 57 Hz 10 g 57 TO 500 Hz 20 g 500 TO 3000 Hz
VIBRATION, RANDOM: *	Z, Y & X ENCLOSURES	0.4 g ² /Hz 50-2000Hz
	T, W & M ENCLOSURES	0.2 g ² /Hz 50-2000Hz
DIELECTRIC STRENGTH AT SEA LEVEL:	ALL CIRCUITS TO GROUND AND CIRCUIT TO CIRCUIT.	1000 V rms
	COIL TO GROUND	1000 V rms
DIELECTRIC STRENGTH AT 80,000 FEET:		250 V rms
INSULATION RESISTANCE:	INITIAL (500 VDC)	100 MΩ MINIMUM
	AFTER LIFE OR ENVIRONMENTAL TESTS	50 MΩ MINIMUM
OPERATE TIME AT NOMINAL VOLTAGE:		4 ms OR LESS
RELEASE TIME AT NOMINAL VOLTAGE:		4 ms OR LESS

* Max. contact opening under vibration or shock 10 microseconds



Tyco Electronics Mid-Range Military/Aerospace Relays

5 AMPERES, DPDT

Below are shown the standard terminal types and the enclosures available. Specify the assembly as indicated under How To Order. Dimensions are shown in inches $\pm .010$ and (Millimeters $\pm .25$).

TERMINALS

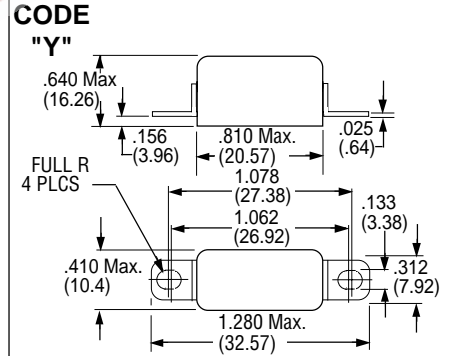
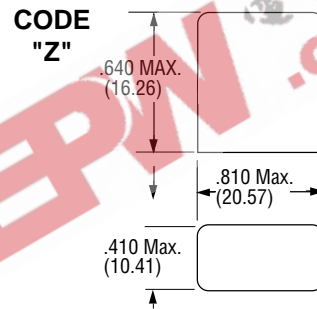
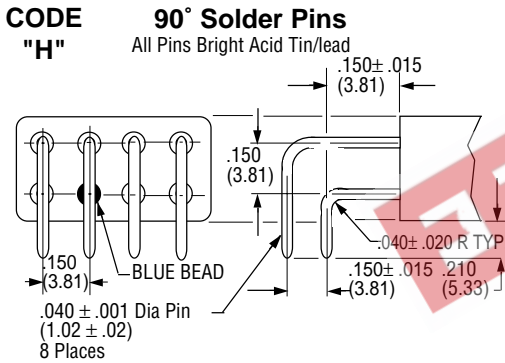
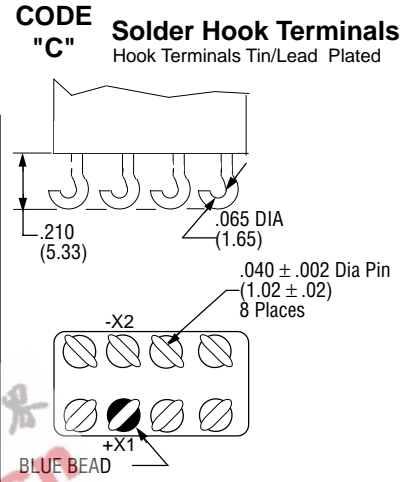
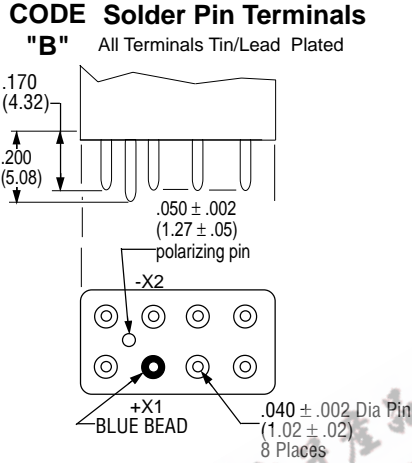
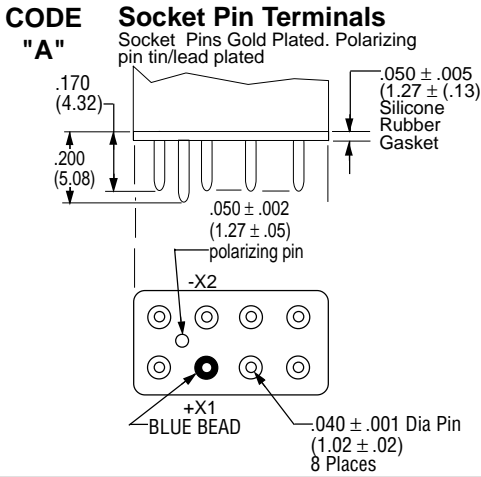

ENCLOSURES

All Enclosures have Cupro-Nickel Cans bright acid tin/lead plated after assembly to terminal headers.

Dimensions: Inches $\pm .010$ (mm $\pm .25$)

Enclosure "T" is for use with track mounted sockets and requires socket pin terminals, but no gasket. The gasket is included in the socket assembly.

CODE

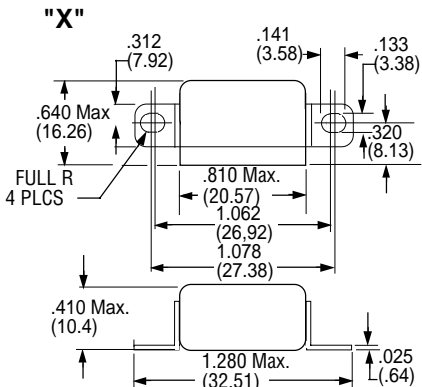

CODE

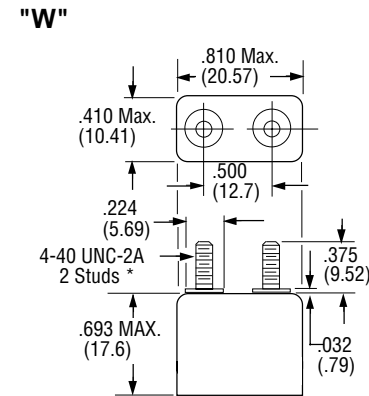

*Metric threads available, To specify use \square in place of \square

CODE

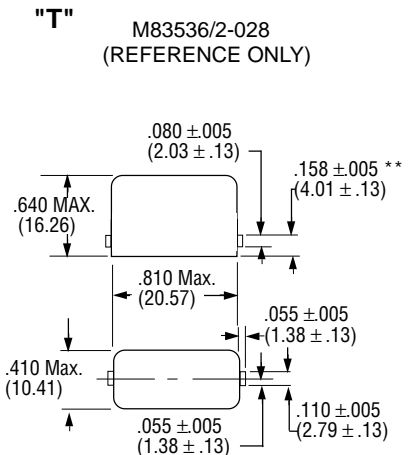

NOTE: FOR USE WITH TRACK MOUNT PER MIL-R-6106/23
** MEASURED FROM SURFACE OF HEADER



Tyco Electronics Mid-Range Military/Aerospace Relays

5 AMPERES, DPDT

TERMINAL WIRING

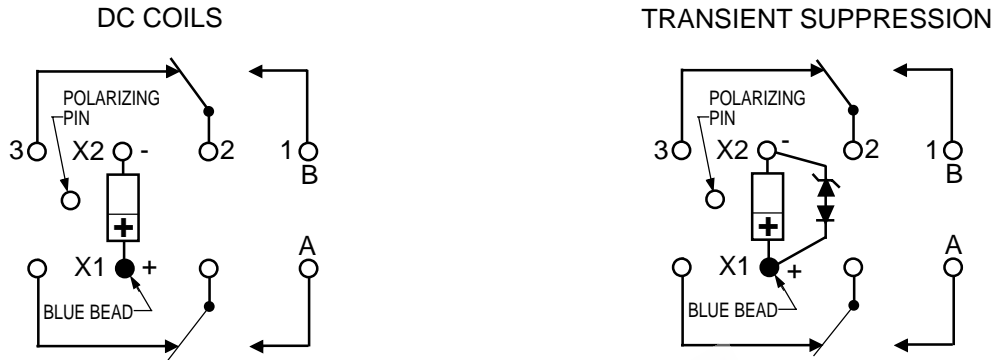

NOTE: Polarity must be observed with DC coil supply. Relay is polarized with a permanent magnet and will not operate or be damaged by reverse polarity.

Diodes used in transient suppression and in AC rectifier circuits have peak inverse voltage rating of 600 VDC minimum. Zener diodes have a minimum rating of 1 watt.

Terminal designations are for reference only and do not appear on the header.

TERMINAL LAYOUT

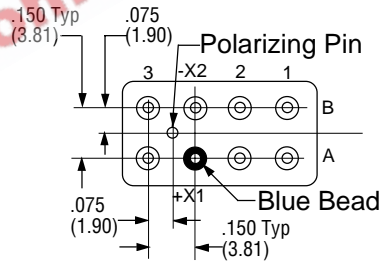

HOW TO ORDER

(EXAMPLE) _____ **FCB-205- A Y 4**

RELAY TYPE _____

TERMINALS (Socket Pins) _____

ENCLOSURE (With Flanges) _____

COIL (28 VDC With Transient Suppression). _____

NOTE: Only DC coil models are QPL Approved