

LM236-2.5, LM336-2.5, LM336B-2.5 2.5-V INTEGRATED REFERENCE CIRCUITS

SLVS063E – NOVEMBER 1988 – REVISED OCTOBER 2003

- Low Temperature Coefficient
- Wide Operating Current . . . 400 μ A to 10 mA
- 0.27- Ω Dynamic Impedance
- \pm 1% Tolerance Available
- Specified Temperature Stability
- Easily Trimmed for Minimum Temperature Drift
- Fast Turnon

D PACKAGE
(TOP VIEW)

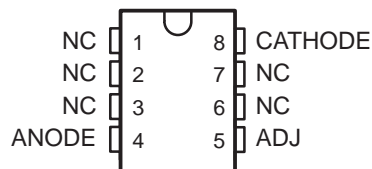

NC – No internal connection

LM336-2.5, LM336B-2.5 . . . LP PACKAGE
(TOP VIEW)



description/ordering information

The LM236-2.5, LM336-2.5, and LM336B-2.5 integrated circuits are precision 2.5-V shunt regulator diodes. These reference circuits operate as low-temperature-coefficient 2.5-V Zener diodes with a 0.2- Ω dynamic impedance. A third terminal provided on the circuit allows the reference voltage and temperature coefficient to be trimmed easily.

The series is useful as precision 2.5-V low-voltage references (V_Z) for digital voltmeters, power supplies, or operational-amplifier circuitry. The 2.5-V voltage reference makes it convenient to obtain a stable reference from 5-V logic supplies. Devices in this series operate as shunt regulators, and can be used as either positive or negative voltage references.

The LM236-2.5 is characterized for operation from -25°C to 85°C . The LM336-2.5 and LM336B-2.5 are characterized for operation from 0°C to 70°C .

ORDERING INFORMATION

T_A	PACKAGE†		ORDERABLE PART NUMBER	TOP-SIDE MARKING
0°C to 70°C	SOIC (D)	Tube of 75	LM336D-2-5	336-25
		Reel of 2500	LM336DR-2-5	
		Tube of 75	LM336BD-2-5	336B25
		Reel of 2500	LM336BDR-2-5	
	TO-226 / TO-92 (LP)	Bulk of 1000	LM336LP-2-5	336-25
		Reel of 2000	LM336LPR-2-5	
		Bulk of 1000	LM336BLP-2-5	336B25
		Reel of 2000	LM336BLPR-2-5	
-25°C to 85°C	SOIC (D)	Tube of 75	LM236D-2-5	236-25
		Reel of 2500	LM236DR-2-5	

† Package drawings, standard packing quantities, thermal data, symbolization, and PCB design guidelines are available at www.ti.com/sc/package.



Please be aware that an important notice concerning availability, standard warranty, and use in critical applications of Texas Instruments semiconductor products and disclaimers thereto appears at the end of this data sheet.

PRODUCTION DATA information is current as of publication date. Products conform to specifications per the terms of Texas Instruments standard warranty. Production processing does not necessarily include testing of all parameters.

 **TEXAS
INSTRUMENTS**

POST OFFICE BOX 655303 • DALLAS, TEXAS 75265

Copyright © 2003, Texas Instruments Incorporated

LM236-2.5, LM336-2.5, LM336B-2.5 2.5-V INTEGRATED REFERENCE CIRCUITS

SLVS063E – NOVEMBER 1988 – REVISED OCTOBER 2003

symbol

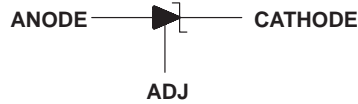

schematic diagram

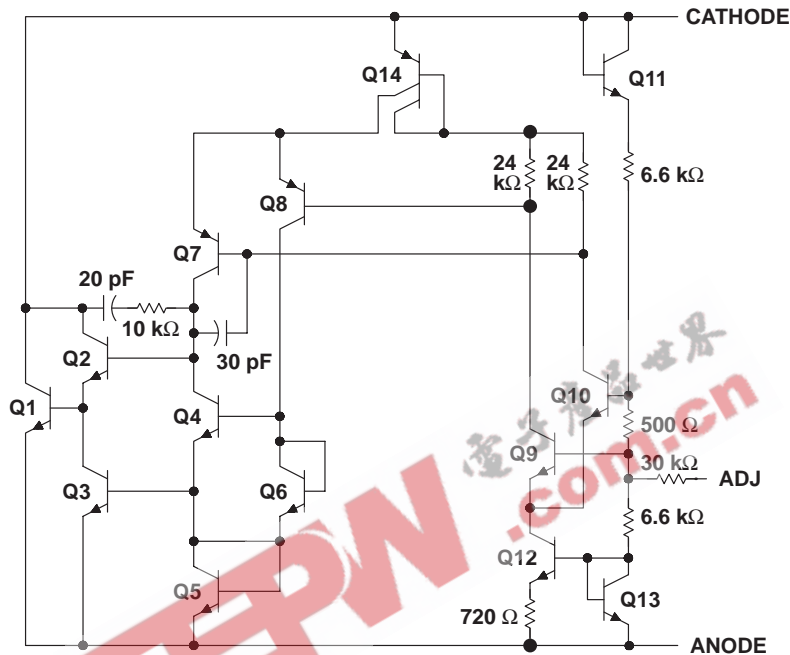

NOTE A: All component values are nominal.

absolute maximum ratings over operating free-air temperature range (unless otherwise noted)†

Reverse current, I_R	20 mA
Forward current, I_F	10 mA
Package thermal impedance, θ_{JA} (see Notes 1 and 2): D package	97°C/W
LP package	140°C/W
Operating virtual junction temperature, T_J	150°C
Storage temperature range, T_{stg}	-65°C to 150°C

† Stresses beyond those listed under "absolute maximum ratings" may cause permanent damage to the device. These are stress ratings only, and functional operation of the device at these or any other conditions beyond those indicated under "recommended operating conditions" is not implied. Exposure to absolute-maximum-rated conditions for extended periods may affect device reliability.

NOTES: 1. Maximum power dissipation is a function of $T_J(\max)$, θ_{JA} , and T_A . The maximum allowable power dissipation at any allowable ambient temperature is $P_D = (T_J(\max) - T_A)/\theta_{JA}$. Operating at the absolute maximum T_J of 150°C can impact reliability.
2. The package thermal impedance is calculated in accordance with JESD 51-7.

recommended operating conditions

		MIN	MAX	UNIT	
T_A	Operating free-air temperature	LM236-2.5	-25	85	°C
		LM336-2.5, LM336B-2.5	0	70	

LM236-2.5, LM336-2.5, LM336B-2.5 2.5-V INTEGRATED REFERENCE CIRCUITS

SLVS063E – NOVEMBER 1988 – REVISED OCTOBER 2003

electrical characteristics at specified free-air temperature (unless otherwise noted)

PARAMETER	TEST CONDITIONS	T _A †	LM236-2.5			LM336-2.5			UNIT		
			MIN	TYP	MAX	MIN	TYP	MAX			
V _Z	Reference voltage	I _Z = 1 mA	LM236, LM336	25°C	2.44	2.49	2.54	2.39	2.49	2.59	V
			LM336B					2.44	2.49	2.54	
ΔV _Z (ΔT)	Change in reference voltage with temperature	V _Z adjusted to 2.490 V, I _Z = 1 mA		Full range		3.5	9		1.8	6	mV
ΔV _Z (ΔI)	Change in reference voltage with current	I _Z = 400 μA to 10 mA		25°C		2.6	6		2.6	10	mV
				Full range		3	10		3	12	
ΔV _Z (Δt)	Long-term change in reference voltage	I _Z = 1 mA		25°C		20			20		ppm/khr
z _Z	Reference impedance	I _Z = 1 mA, f = 1 kHz		25°C		0.2	0.6		0.2	1	W
				Full range		0.4	1		0.4	1.4	

† Full range is –25°C to 85°C for the LM236-2.5 and 0°C to 70°C for the LM336-2.5 and LM336B-2.5.

EEPW.com.cn 电子产品世界

LM236-2.5, LM336-2.5, LM336B-2.5 2.5-V INTEGRATED REFERENCE CIRCUITS

SLVS063E – NOVEMBER 1988 – REVISED OCTOBER 2003

TYPICAL CHARACTERISTICS

CHANGE IN REFERENCE VOLTAGE
vs
REFERENCE CURRENT

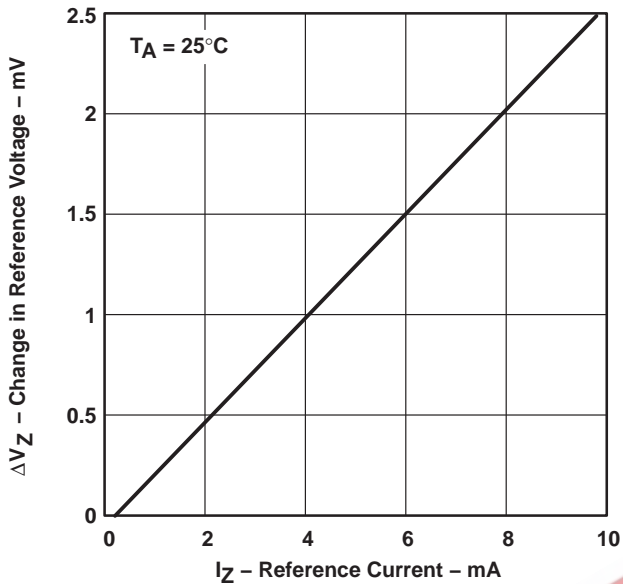

Figure 1

NOISE VOLTAGE
vs
FREQUENCY

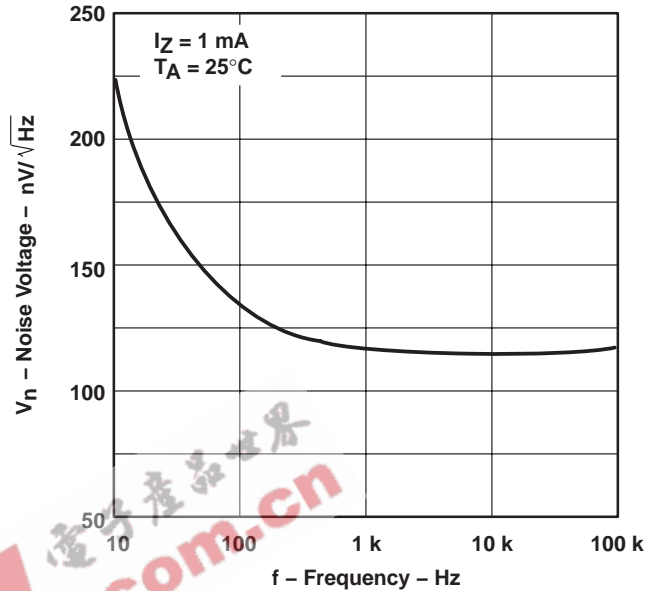

Figure 2

REFERENCE IMPEDANCE
vs
FREQUENCY

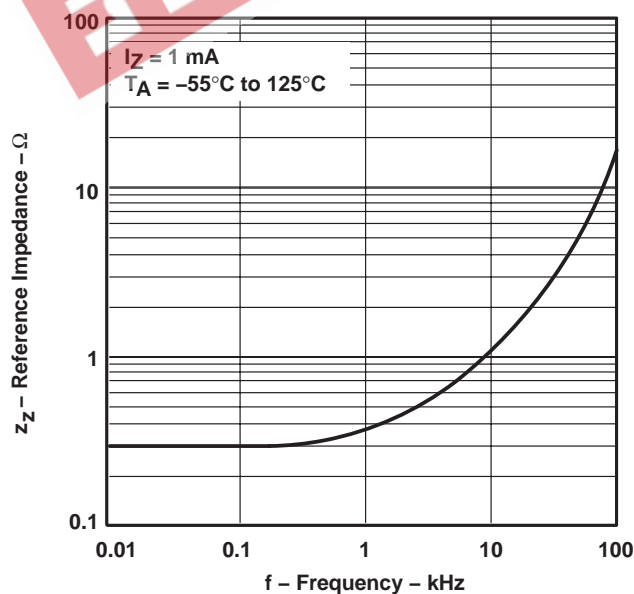

Figure 3

LM236-2.5, LM336-2.5, LM336B-2.5 2.5-V INTEGRATED REFERENCE CIRCUITS

SLVS063E – NOVEMBER 1988 – REVISED OCTOBER 2003

APPLICATION INFORMATION

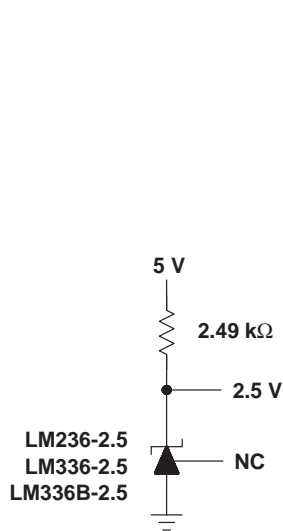
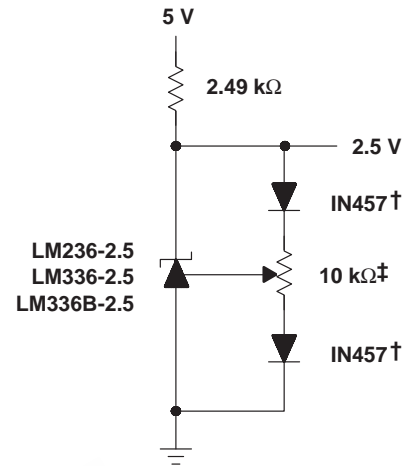

Figure 4. 2.5-V Reference



† Any silicon signal diode
‡ Adjust to 2.49 V

Figure 5. 2.5-V Reference
With Minimum Temperature Coefficient

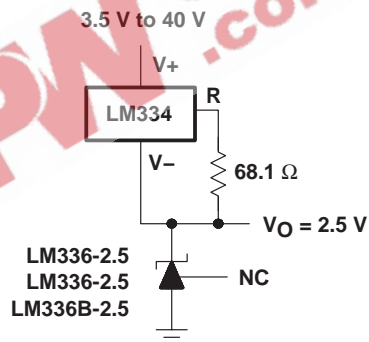

Figure 6. Wide-Input-Range Reference

PACKAGING INFORMATION

Orderable Device	Status ⁽¹⁾	Package Type	Package Drawing	Pins	Package Qty	Eco Plan ⁽²⁾	Lead/Ball Finish	MSL Peak Temp ⁽³⁾
LM236D-2-5	ACTIVE	SOIC	D	8	75	Pb-Free (RoHS)	CU NIPDAU	Level-2-260C-1 YEAR/ Level-1-235C-UNLIM
LM236DR-2-5	ACTIVE	SOIC	D	8	2500	Pb-Free (RoHS)	CU NIPDAU	Level-2-260C-1 YEAR/ Level-1-235C-UNLIM
LM236LP-2-5	OBSOLETE	TO-92	LP	3		None	Call TI	Call TI
LM336BD-2-5	ACTIVE	SOIC	D	8	75	Pb-Free (RoHS)	CU NIPDAU	Level-2-260C-1 YEAR/ Level-1-235C-UNLIM
LM336BDR-2-5	ACTIVE	SOIC	D	8	2500	Pb-Free (RoHS)	CU NIPDAU	Level-2-260C-1 YEAR/ Level-1-235C-UNLIM
LM336BLP-2-5	ACTIVE	TO-92	LP	3	1000	None	CU SNPB	Level-NC-NC-NC
LM336BLPR-2-5	ACTIVE	TO-92	LP	3	2000	None	CU SNPB	Level-NC-NC-NC
LM336D-2-5	ACTIVE	SOIC	D	8	75	Pb-Free (RoHS)	CU NIPDAU	Level-2-260C-1 YEAR/ Level-1-235C-UNLIM
LM336DR-2-5	ACTIVE	SOIC	D	8	2500	Pb-Free (RoHS)	CU NIPDAU	Level-2-260C-1 YEAR/ Level-1-235C-UNLIM
LM336LP-2-5	ACTIVE	TO-92	LP	3	1000	None	CU SNPB	Level-NC-NC-NC
LM336LPR-2-5	ACTIVE	TO-92	LP	3	2000	None	CU SNPB	Level-NC-NC-NC

⁽¹⁾ The marketing status values are defined as follows:

ACTIVE: Product device recommended for new designs.

LIFEBUY: TI has announced that the device will be discontinued, and a lifetime-buy period is in effect.

NRND: Not recommended for new designs. Device is in production to support existing customers, but TI does not recommend using this part in a new design.

PREVIEW: Device has been announced but is not in production. Samples may or may not be available.

OBSOLETE: TI has discontinued the production of the device.

⁽²⁾ Eco Plan - May not be currently available - please check <http://www.ti.com/productcontent> for the latest availability information and additional product content details.

None: Not yet available Lead (Pb-Free).

Pb-Free (RoHS): TI's terms "Lead-Free" or "Pb-Free" mean semiconductor products that are compatible with the current RoHS requirements for all 6 substances, including the requirement that lead not exceed 0.1% by weight in homogeneous materials. Where designed to be soldered at high temperatures, TI Pb-Free products are suitable for use in specified lead-free processes.

Green (RoHS & no Sb/Br): TI defines "Green" to mean "Pb-Free" and in addition, uses package materials that do not contain halogens, including bromine (Br) or antimony (Sb) above 0.1% of total product weight.

⁽³⁾ MSL, Peak Temp. -- The Moisture Sensitivity Level rating according to the JEDEC industry standard classifications, and peak solder temperature.

Important Information and Disclaimer: The information provided on this page represents TI's knowledge and belief as of the date that it is provided. TI bases its knowledge and belief on information provided by third parties, and makes no representation or warranty as to the accuracy of such information. Efforts are underway to better integrate information from third parties. TI has taken and continues to take reasonable steps to provide representative and accurate information but may not have conducted destructive testing or chemical analysis on incoming materials and chemicals. TI and TI suppliers consider certain information to be proprietary, and thus CAS numbers and other limited information may not be available for release.

In no event shall TI's liability arising out of such information exceed the total purchase price of the TI part(s) at issue in this document sold by TI to Customer on an annual basis.

MECHANICAL DATA

D (R-PDSO-G8)

PLASTIC SMALL-OUTLINE PACKAGE

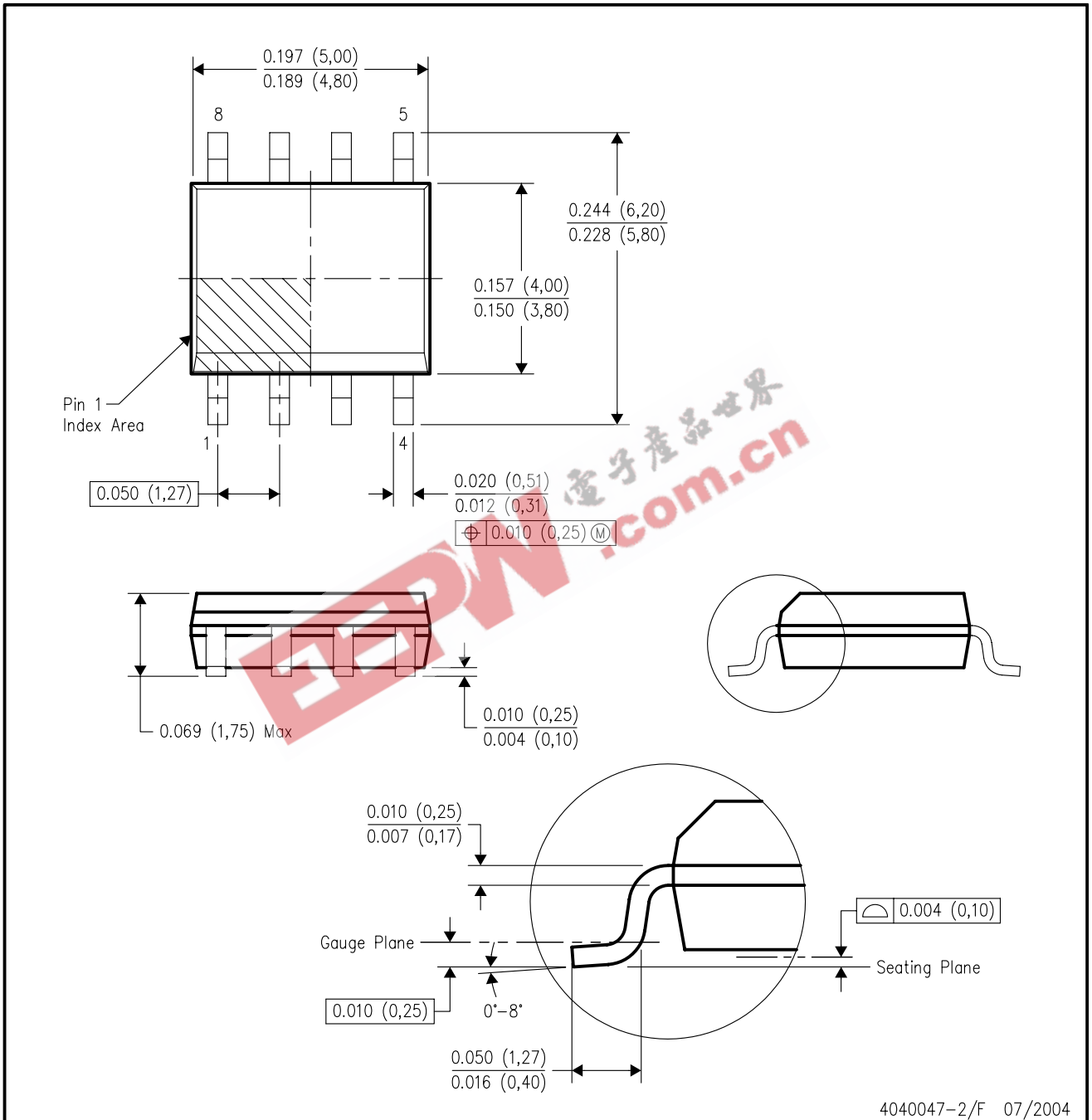

4040047-2/F 07/2004

- NOTES:
- All linear dimensions are in inches (millimeters).
 - This drawing is subject to change without notice.
 - Body dimensions do not include mold flash or protrusion not to exceed 0.006 (0,15).
 - Falls within JEDEC MS-012 variation AA.

MECHANICAL DATA

MSOT002A – OCTOBER 1994 – REVISED NOVEMBER 2001

LP (O-PBCY-W3)

PLASTIC CYLINDRICAL PACKAGE

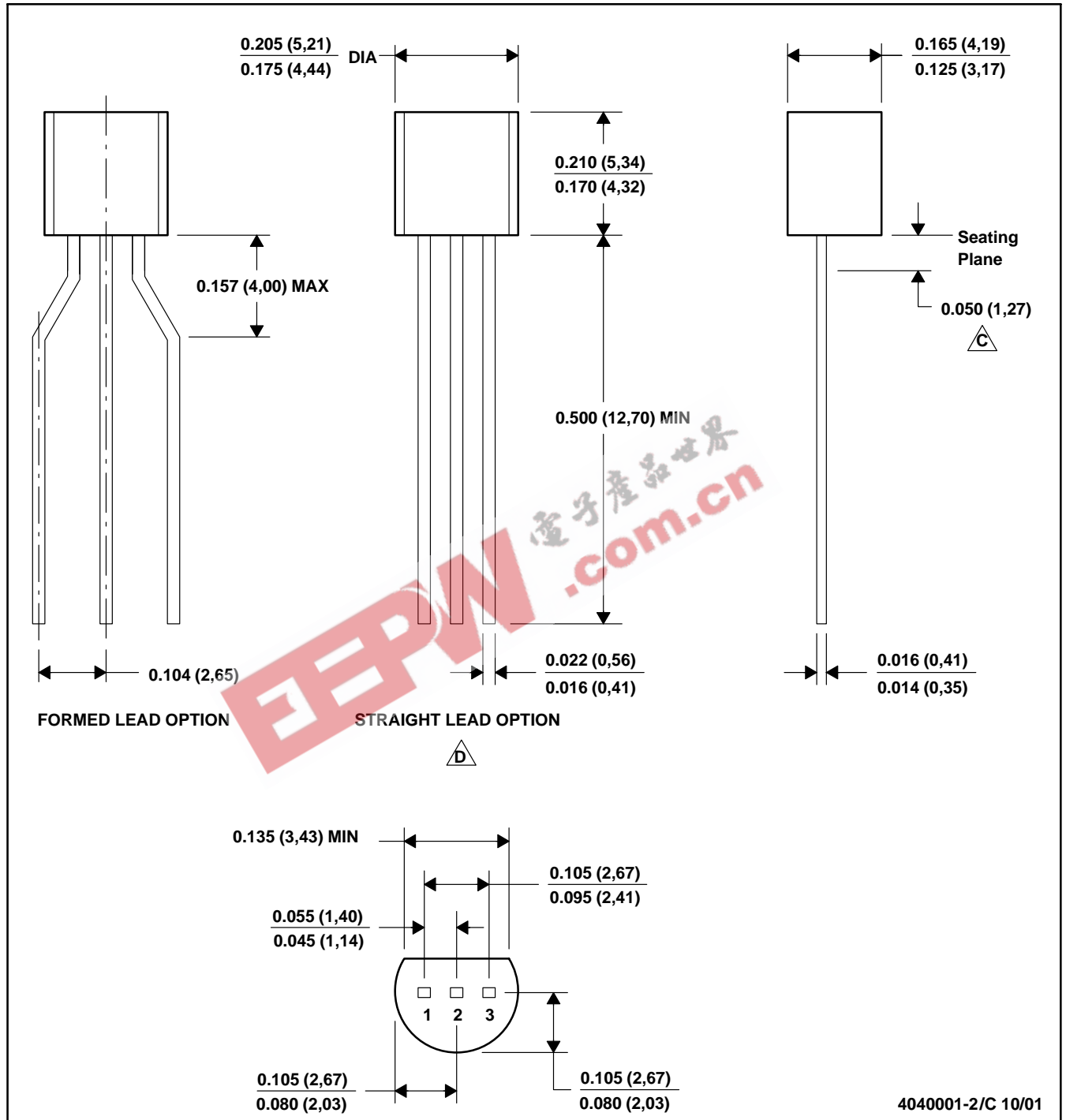

- NOTES: A. All linear dimensions are in inches (millimeters).
 B. This drawing is subject to change without notice.
 C. Lead dimensions are not controlled within this area
 D. Falls within JEDEC TO-226 Variation AA (TO-226 replaces TO-92)
 E. Shipping Method:
 Straight lead option available in bulk pack only.
 Formed lead option available in tape & reel or ammo pack.

MECHANICAL DATA

MSOT002A – OCTOBER 1994 – REVISED NOVEMBER 2001

LP (O-PBCY-W3)

PLASTIC CYLINDRICAL PACKAGE

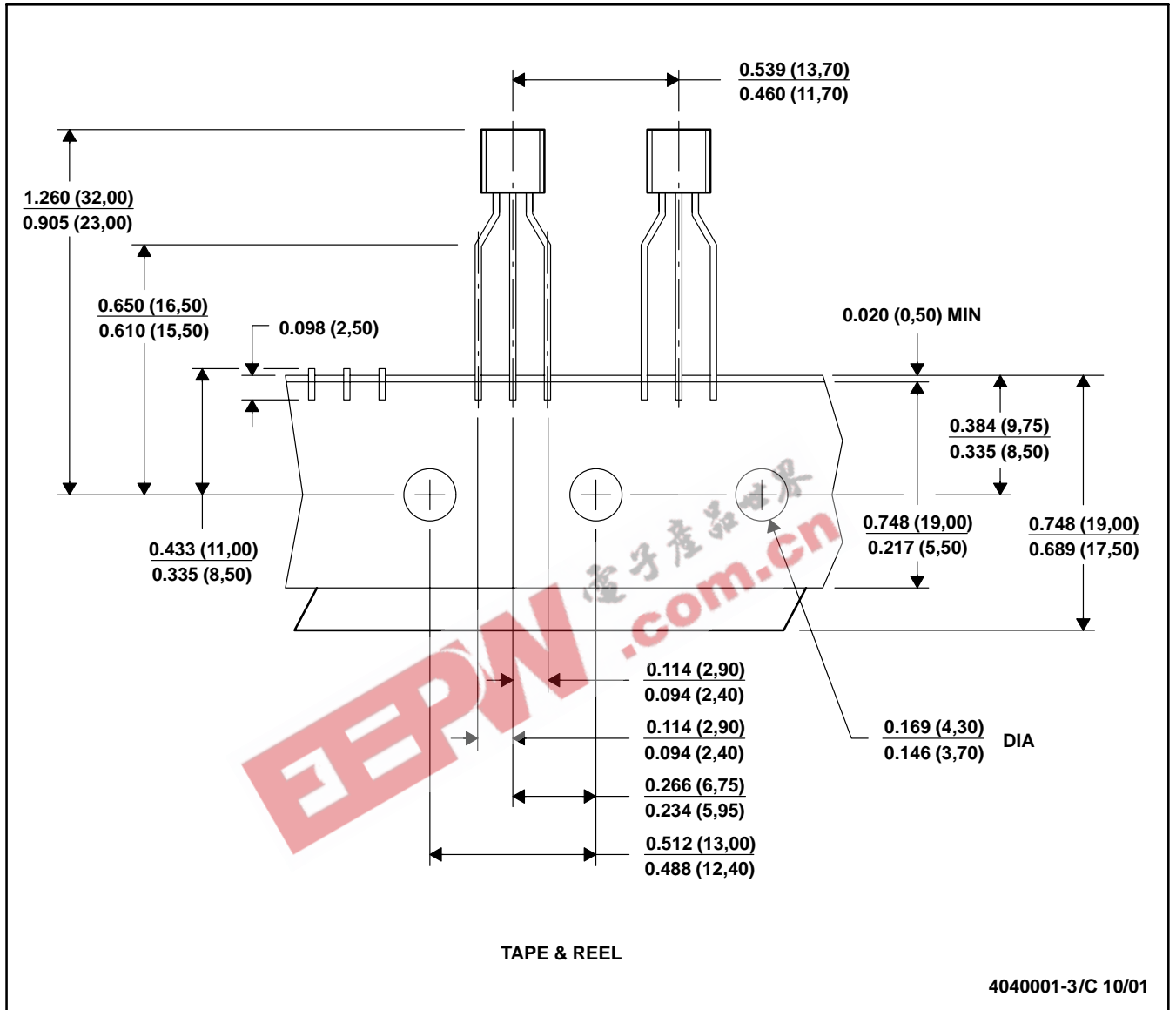

- NOTES:
- All linear dimensions are in inches (millimeters).
 - This drawing is subject to change without notice.
 - Tape and Reel information for the Format Lead Option package.

IMPORTANT NOTICE

Texas Instruments Incorporated and its subsidiaries (TI) reserve the right to make corrections, modifications, enhancements, improvements, and other changes to its products and services at any time and to discontinue any product or service without notice. Customers should obtain the latest relevant information before placing orders and should verify that such information is current and complete. All products are sold subject to TI's terms and conditions of sale supplied at the time of order acknowledgment.

TI warrants performance of its hardware products to the specifications applicable at the time of sale in accordance with TI's standard warranty. Testing and other quality control techniques are used to the extent TI deems necessary to support this warranty. Except where mandated by government requirements, testing of all parameters of each product is not necessarily performed.

TI assumes no liability for applications assistance or customer product design. Customers are responsible for their products and applications using TI components. To minimize the risks associated with customer products and applications, customers should provide adequate design and operating safeguards.

TI does not warrant or represent that any license, either express or implied, is granted under any TI patent right, copyright, mask work right, or other TI intellectual property right relating to any combination, machine, or process in which TI products or services are used. Information published by TI regarding third-party products or services does not constitute a license from TI to use such products or services or a warranty or endorsement thereof. Use of such information may require a license from a third party under the patents or other intellectual property of the third party, or a license from TI under the patents or other intellectual property of TI.

Reproduction of information in TI data books or data sheets is permissible only if reproduction is without alteration and is accompanied by all associated warranties, conditions, limitations, and notices. Reproduction of this information with alteration is an unfair and deceptive business practice. TI is not responsible or liable for such altered documentation.

Resale of TI products or services with statements different from or beyond the parameters stated by TI for that product or service voids all express and any implied warranties for the associated TI product or service and is an unfair and deceptive business practice. TI is not responsible or liable for any such statements.

Following are URLs where you can obtain information on other Texas Instruments products and application solutions:

Products		Applications	
Amplifiers	amplifier.ti.com	Audio	www.ti.com/audio
Data Converters	dataconverter.ti.com	Automotive	www.ti.com/automotive
DSP	dsp.ti.com	Broadband	www.ti.com/broadband
Interface	interface.ti.com	Digital Control	www.ti.com/digitalcontrol
Logic	logic.ti.com	Military	www.ti.com/military
Power Mgmt	power.ti.com	Optical Networking	www.ti.com/opticalnetwork
Microcontrollers	microcontroller.ti.com	Security	www.ti.com/security
		Telephony	www.ti.com/telephony
		Video & Imaging	www.ti.com/video
		Wireless	www.ti.com/wireless

Mailing Address: Texas Instruments
Post Office Box 655303 Dallas, Texas 75265