



1.5MHz, 350mA Synchronous Step-Down Regulator in SOT23-5

FEATURES

- High Efficiency: Up to 96%
- Very Low Quiescent Current: Only 20 μ A During Operation
- 350mA Output Current
- 2.5V to 7.4V Input Voltage Range
- 1.5MHz Constant Frequency Operation
- No Schottky Diode Required
- Low Dropout Operation: 100% Duty Cycle
- 0.6V Reference Allows Low Output Voltages
- Shutdown Mode Draws $\leq 1\mu$ A Supply Current
- Current Mode Operation for Excellent Line and Load Transient Response
- Overtemperature Protected
- Low Profile (1mm) SOT23-5 Package

APPLICATIONS

- Cellular Telephones
- Personal Information Appliances
- Wireless and DSL Modems
- Digital Still Cameras
- MP3 Players
- Portable Instruments

DESCRIPTION

The KB3408 is a high efficiency monolithic synchronous buck regulator using a constant frequency, current mode architecture. The device is available in an adjustable version and fixed output voltages of 1.8V and 3.3V. Supply current during operation is only 20 μ A and drops to $\leq 1\mu$ A in shutdown. The 2.5V to 7.4V input voltage range makes the KB3408 ideally suited for single Li-Ion battery-powered applications. 100% duty cycle provides low dropout operation, extending battery life in portable systems. Automatic Burst Mode operation increases efficiency at light loads, further extending battery life.

Switching frequency is internally set at 1.5MHz, allowing the use of small surface mount inductors and capacitors.

The internal synchronous switch increases efficiency and eliminates the need for an external Schottky diode. Low output voltages are easily supported with the 0.6V feedback reference voltage. The KB3408 is available in a low profile (1mm) SOT23-5 package.

TYPICAL APPLICATION

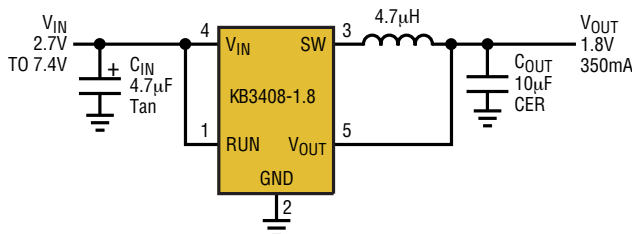

Figure 1a. High Efficiency Step-Down Converter

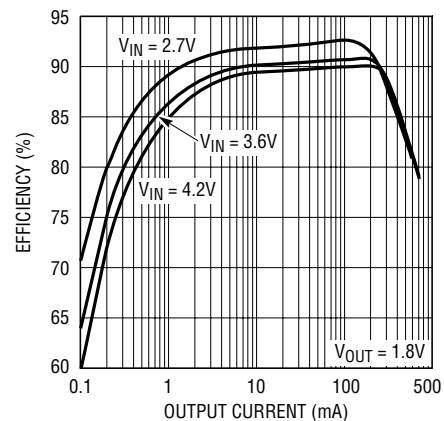

Figure 1b. Efficiency vs Load Current



ABSOLUTE MAXIMUM RATINGS (Note 1)

Input Supply Voltage	-0.3V to 7.5V	Peak SW Sink and Source Current	350mA
RUN, V _{FB} Voltages	-0.3V to V _{IN}	Operating Temperature Range (Note 2) ..	-40°C to 85°C
SW Voltage	-0.3V to (V _{IN} + 0.3V)	Junction Temperature (Note 3)	125°C
P-Channel Switch Source Current (DC)	400mA	Storage Temperature Range	-65°C to 150°C
N-Channel Switch Sink Current (DC)	400mA	Lead Temperature (Soldering, 10 sec).....	300°C

PACKAGE/ORDER INFORMATION

	<p>ORDER PART NUMBER</p> <p>KB3408-ADJ</p> <p>Top Marking</p> <p>A19x</p> <p>x: DateCode</p>		<p>ORDER PART NUMBER</p> <p>KB3408B-1.8</p> <p>Top Marking</p> <p>XXXX</p> <p>KB3408B-3.3</p> <p>Top Marking</p> <p>XXXX</p>
--	---	--	--

ELECTRICAL CHARACTERISTICS

The ● denotes specifications which apply over the full operating temperature range, otherwise specifications are T_A = 25°C. V_{IN} = 3.6V unless otherwise specified.

SYMBOL	PARAMETER	CONDITIONS	MIN	TYP	MAX	UNITS
I _{VFB}	Feedback Current	●			±30	nA
V _{FB}	Regulated Feedback Voltage	KB3408 (Note 4) T _A = 25°C KB3408 (Note 4) 0 °C ≤ T _A ≤ 85°C KB3408 (Note 4) -40 °C ≤ T _A ≤ 85°C	0.5880 0.5865 0.5850	0.6 0.6 0.6	0.6120 0.6135 0.6150	V V V
ΔV _{FB}	Reference Voltage Line Regulation	V _{IN} = 2.5V to 7.4V (Note 4)	●	0.4	1	%/V
V _{OUT}	Regulated Output Voltage	KB3408-1.8, I _{OUT} = 100mA KB3408-3.3, I _{OUT} = 100mA	● ●	1.755 3.246	1.800 3.300 1.845 3.354	V V
ΔV _{OUT}	Output Voltage Line Regulation	V _{IN} = 2.5V to 7.4V	●	0.4	1	%/V
I _{PK}	Peak Inductor Current	V _{IN} = 3V, V _{FB} = 0.5V or V _{OUT} = 90%, Duty Cycle < 35%		0.40 0.45	0.5	A
V _{LOADREG}	Output Voltage Load Regulation			0.5		%
V _{IN}	Input Voltage Range	●	2.5		7.4	V
I _S	Input DC Bias Current	(Note 5) V _{FB} = 0.5V or V _{OUT} = 90%, I _{LOAD} = 0A V _{FB} = 0.62V or V _{OUT} = 103%, I _{LOAD} = 0A V _{RUN} = 0V, V _{IN} = 4.2V		250 20 0.1	400 35 1	μA μA μA
f _{OSC}	Oscillator Frequency	V _{FB} = 0.6V or V _{OUT} = 100% V _{FB} = 0V or V _{OUT} = 0V	●	1.2 210	1.5 1.8	MHz kHz
R _{PFET}	R _{DS(ON)} of P-Channel FET	I _{SW} = 100mA		0.4	0.5	Ω
R _{NFET}	R _{DS(ON)} of N-Channel FET	I _{SW} = -100mA		0.35	0.45	Ω
I _{LSW}	SW Leakage	V _{RUN} = 0V, V _{SW} = 0V or 5V, V _{IN} = 5V		±0.01	±1	μA



ELECTRICAL CHARACTERISTICS

The ● denotes specifications which apply over the full operating temperature range, otherwise specifications are $T_A = 25^\circ\text{C}$.
 $V_{IN} = 3.6\text{V}$ unless otherwise specified.

SYMBOL	PARAMETER	CONDITIONS	MIN	TYP	MAX	UNITS
V_{RUN}	RUN Threshold		● 0.3	1	1.5	V
I_{RUN}	RUN Leakage Current		●	± 0.01	± 1	μA

Note 1: Absolute Maximum Ratings are those values beyond which the life of a device may be impaired.

Note 2: The KB3408 is guaranteed to meet performance specifications from 0°C to 70°C . Specifications over the -40°C to 85°C operating temperature range are assured by design, characterization and correlation with statistical process controls.

Note 3: T_J is calculated from the ambient temperature T_A and power dissipation P_D according to the following formula:

$$KB3408: T_J = T_A + (P_D)(250^\circ\text{C}/\text{W})$$

Note 4: The KB3408 is tested in a proprietary test mode that connects V_{FB} to the output of the error amplifier.

Note 5: Dynamic supply current is higher due to the gate charge being delivered at the switching frequency.

TYPICAL PERFORMANCE CHARACTERISTICS

(From Figure1a Except for the Resistive Divider Resistor Values)

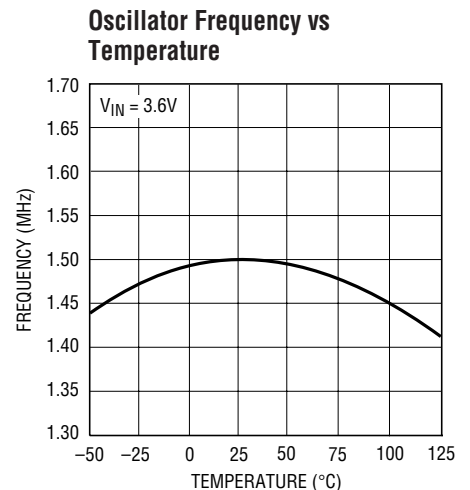
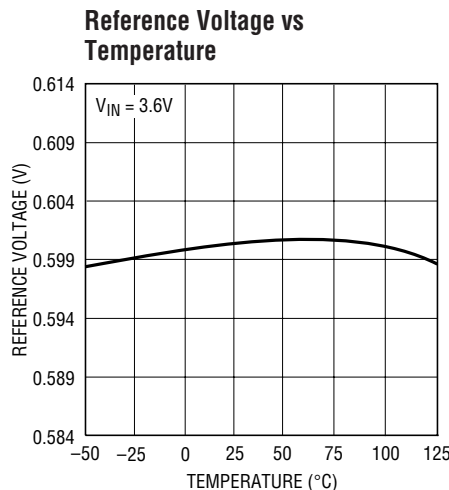
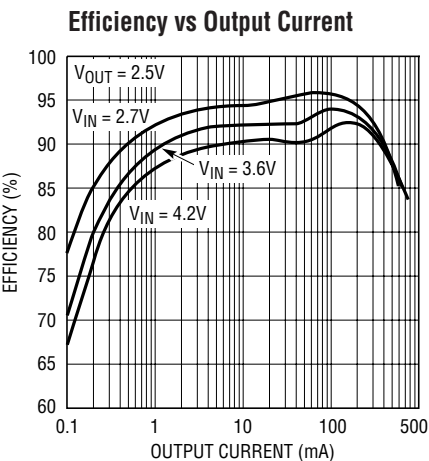
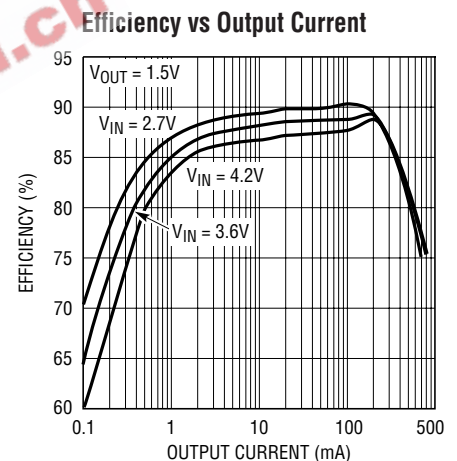
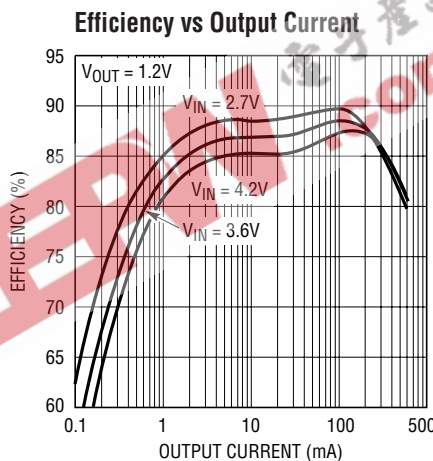
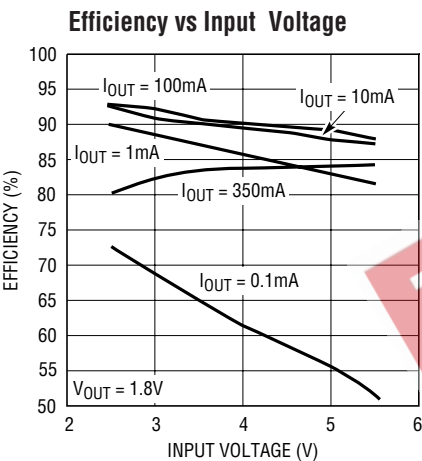



TYPICAL PERFORMANCE CHARACTERISTICS

(From Figure 1a Except for the Resistive Divider Resistor Values)

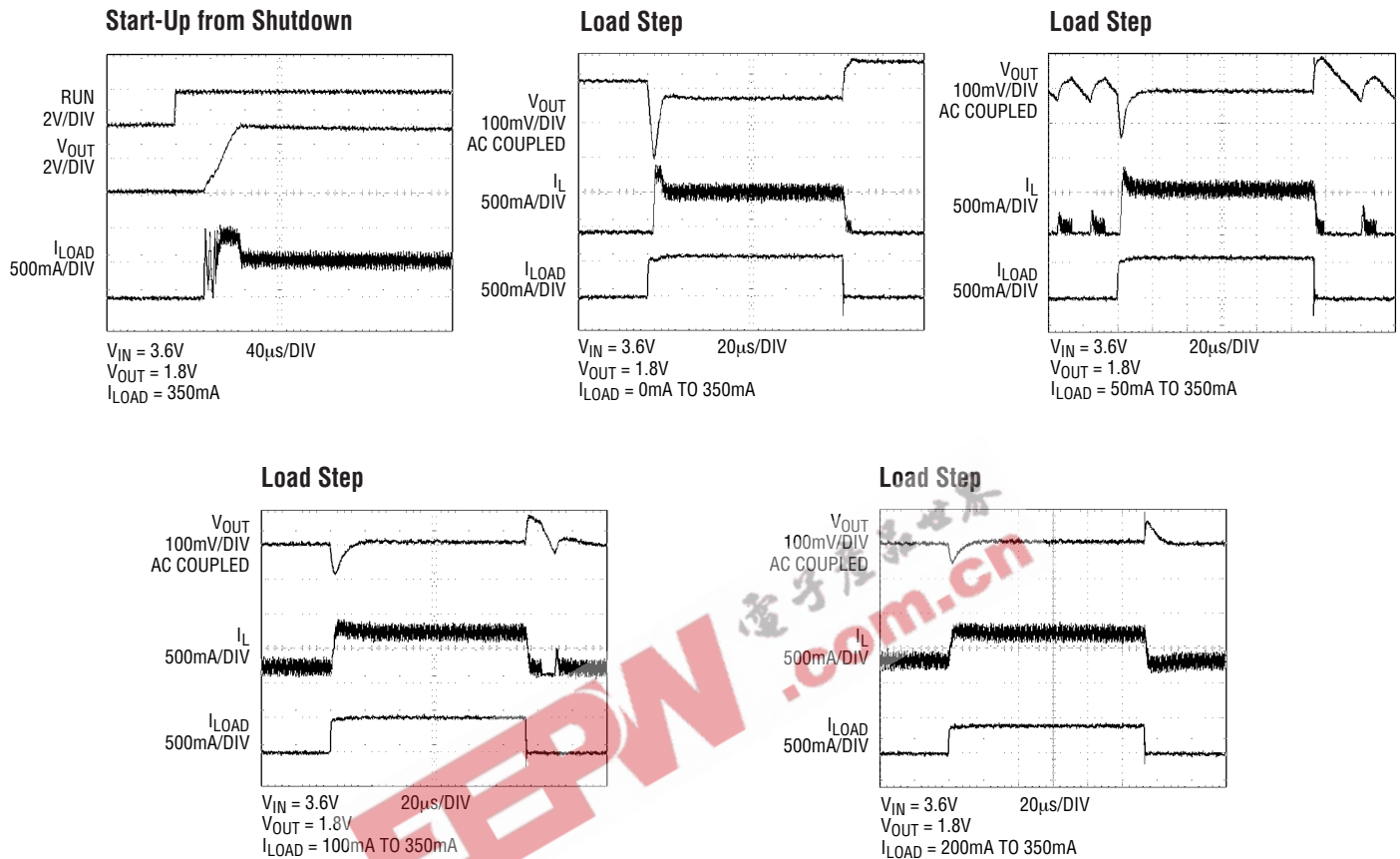

PIN FUNCTIONS

RUN (Pin 1): Run Control Input. Forcing this pin above 1.5V enables the part. Forcing this pin below 0.3V shuts down the device. In shutdown, all functions are disabled drawing <math><1\mu\text{A}</math> supply current. Do not leave RUN floating.

GND (Pin 2): Ground Pin.

SW (Pin 3): Switch Node Connection to Inductor. This pin connects to the drains of the internal main and synchronous power MOSFET switches.

V_{IN} (Pin 4): Main Supply Pin. Must be closely decoupled to GND, Pin 2, with a 2.2µF or greater ceramic capacitor.

V_{FB} (Pin 5) (KB3408): Feedback Pin. Receives the feedback voltage from an external resistive divider across the output.

V_{OUT} (Pin 5) (KB3408-1.8/KB3408-3.3): Output Voltage Feedback Pin. An internal resistive divider divides the output voltage down for comparison to the internal reference voltage.



SIMPLIFIED BLOC DIAGRAM

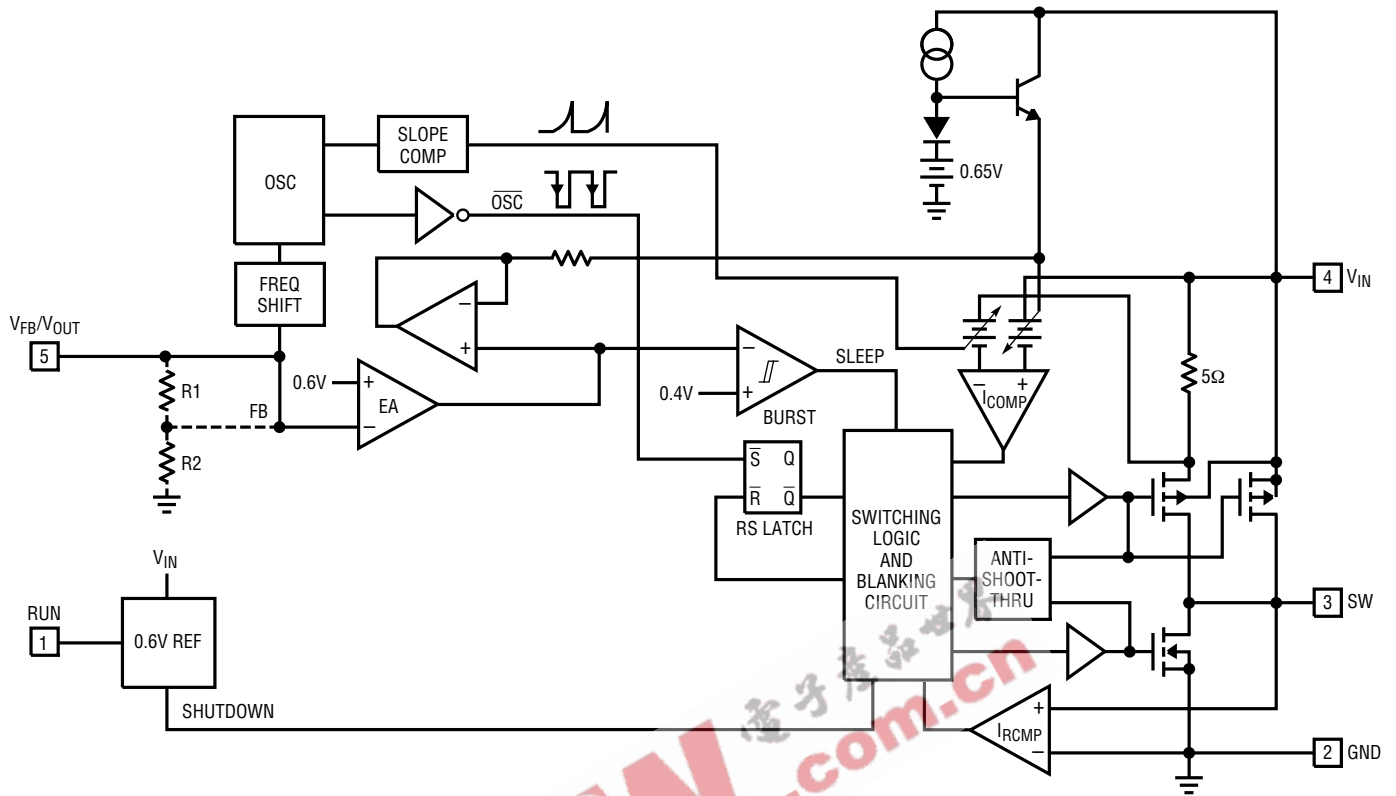

TYPICAL APPLICATION

Tiny 3.3V/350mA Buck Regulator

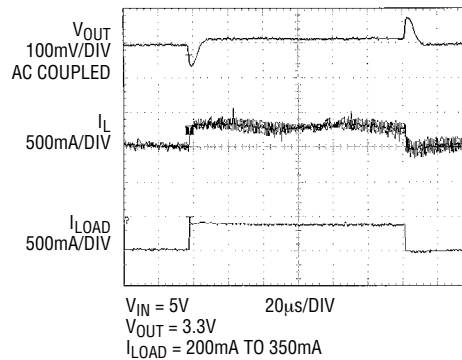
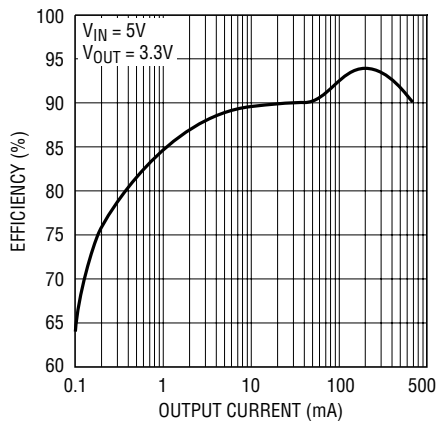
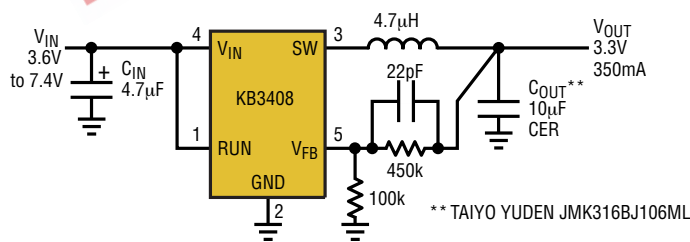



PACAGE DESCRIPTION

S5 Package 5-Lead Plastic TSOT-23(SOT23-5)

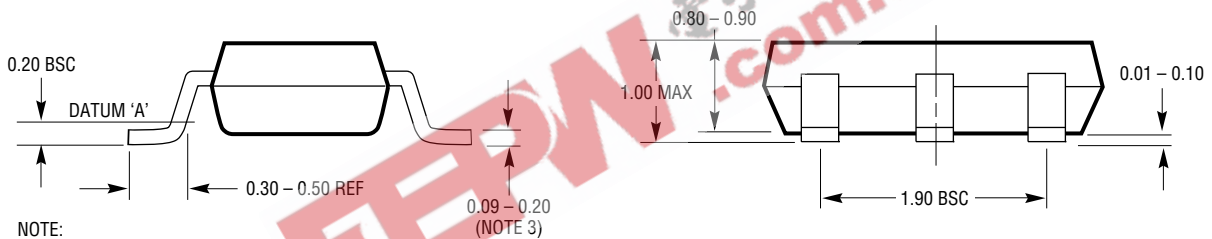
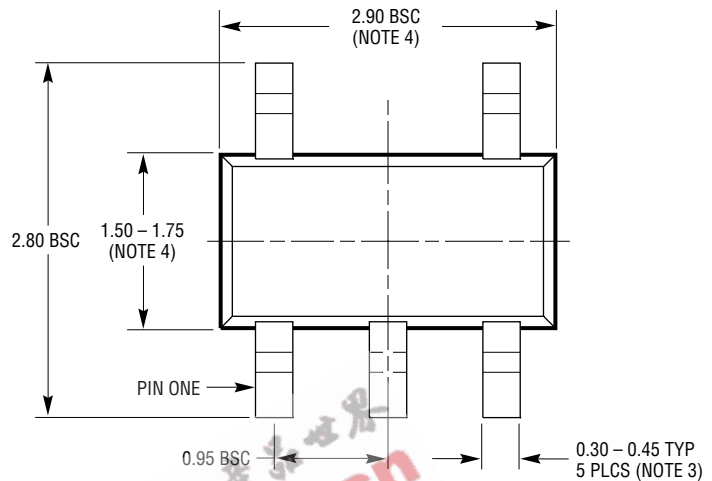
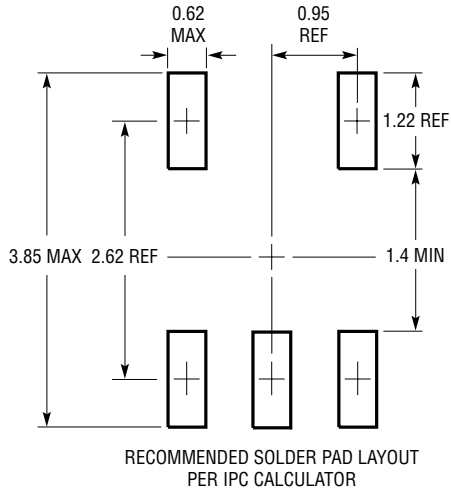

- NOTE:
1. DIMENSIONS ARE IN MILLIMETERS
 2. DRAWING NOT TO SCALE
 3. DIMENSIONS ARE INCLUSIVE OF PLATING
 4. DIMENSIONS ARE EXCLUSIVE OF MOLD FLASH AND METAL BURR
 5. MOLD FLASH SHALL NOT EXCEED 0.254mm
 6. JEDEC PACKAGE REFERENCE IS MO-193