



ST619LB

DC-DC converter regulated 5 V charge pump

Features

- Regulated 5 V ± 4 % charge pump
- Output current guaranteed over temperature: 20 mA ($V_I \geq 2$ V), 30 mA ($V_I \geq 3$ V)
- No inductors; very low EMI noise
- Uses small, inexpensive capacitors
- Logic controlled 1 μ A max shut-down supply current
- Shut down disconnects load from input
- Available in SO-8 and DIP-8 packages

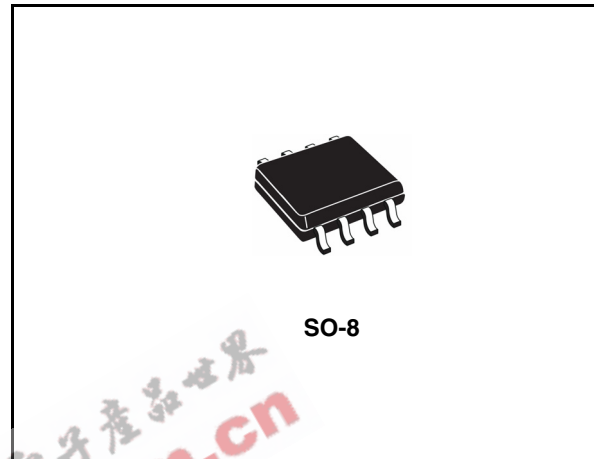

Description

The ST619LB is a step-up charge pump DC-DC converter which delivers a regulated 5 V ± 4 % output at 30 mA and over temperature. The input voltage range is 2 V to 3.6 V (two battery cells).

It requires only four external capacitor: two 0.22 μ F flying capacitors, and 10 μ F capacitors at the input and output.

Low operating supply current (typ. 200 μ A) make the device ideal for small, portable and battery powered applications. When shut down the load is disconnected from the input and the supply current is typically 0.02 μ A. The ST619LB is available in SO-8 package.

Table 1. Device summary

Order codes	SO-8 (tape & reel)
ST619LB	ST619LBDR

Contents

1	Schematic	3
2	Pin configuration	4
3	Operating principle	5
	3.1 Shut down mode	5
4	Maximum ratings	6
5	Electrical characteristics	7
6	Typical performance characteristics	8
7	Application information	10
	7.1 Charge pump capacitors C1 and C2	10
	7.2 Input and output capacitors C3 and C4	10
	7.3 Layout consideration	10
8	Package mechanical data	12
9	Revision history	15

1 Schematic

Figure 1. Schematic diagram

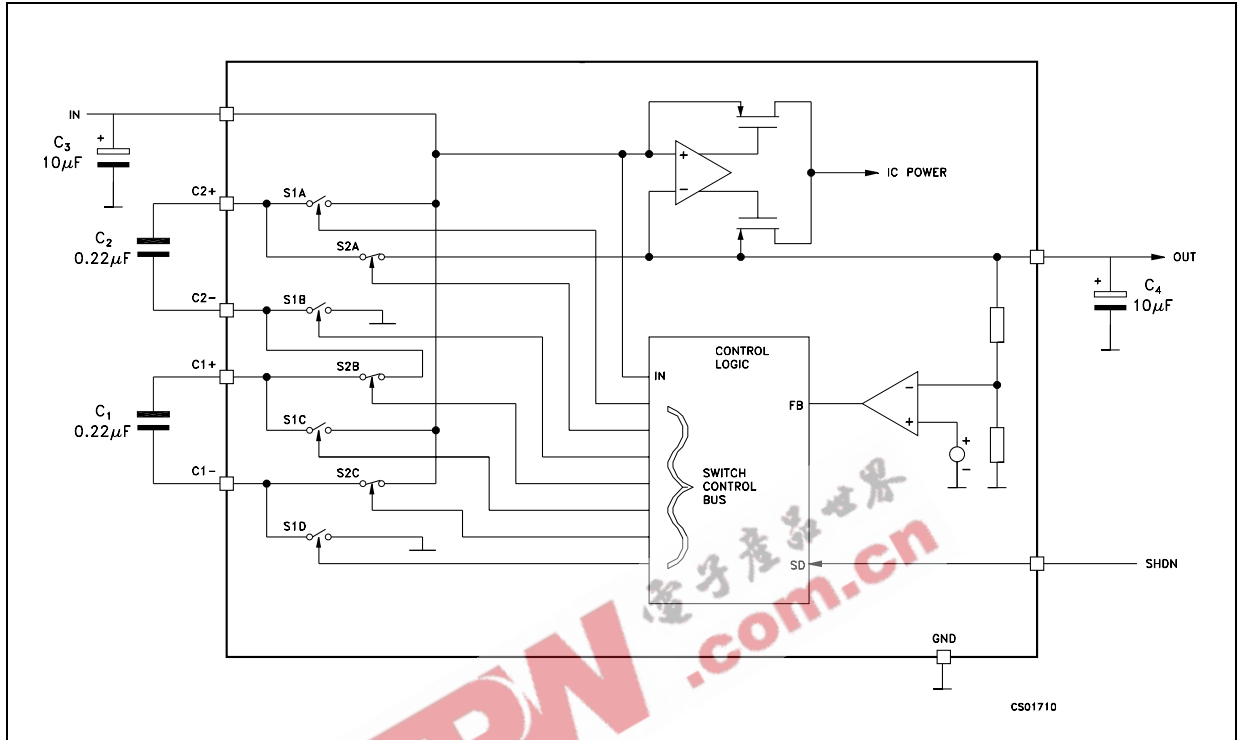

2 Pin configuration

Figure 2. Pin connections (top view)

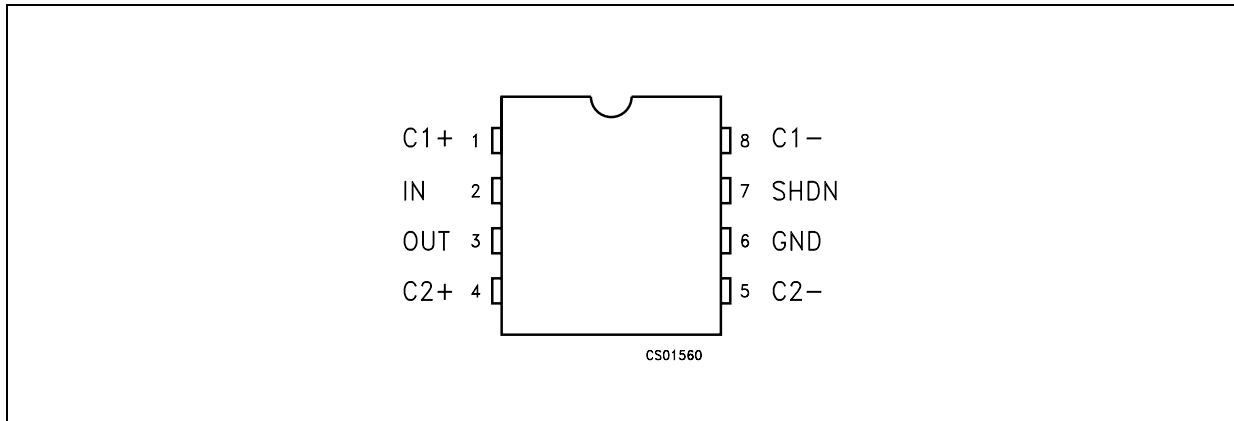

Table 2. Pin description

Pin n°	Symbol	Name and function
1	C1+	Positive terminal for the first charge pump capacitor
2	IN	Input supply voltage
3	OUT	5V output voltage. $V_O=0V$ when in shutdown mode.
4	C2+	Positive terminal for the second charge pump capacitor
5	C2-	Negative terminal for the second charge pump capacitor
6	GND	Ground
7	SHDN	Active high C-MOS logic level shutdown input. SHDN is connected to GND for normal operation.
8	C1-	Negative terminal for the first charge pump capacitor

3 Operating principle

The ST619LB is able to provide a regulated 5 V output from a 2 V to 3.6 V (two battery cells) input. Internal charge pump and external capacitors generate the 5 V output, eliminating the need for inductors. The output voltage is regulated to 5 V, $\pm 4\%$ by a pulse skipping controller that turns on the charge pump when the output voltage begins to drop. To maintain the greatest efficiency the internal charge pump of the device operates as a voltage doubler when V_I ranges from 3.0 V to 3.6 V and as a voltage triple when V_I ranges from 2.0 V to 2.5 V.

When V_I ranges from 2.5 V to 3.0 V, the ST619LB switches between doubler and triple mode on alternating cycles, making a $2.5 \times V_I$ charge pump. To further enhance the efficiency over the input range, an internal comparator selects the higher of V_I or V_O to run the ST619LB's circuitry. With $V_I = 2$ V and $I_O = 20$ mA the typical efficiency value is 80%.

In triple mode (see block diagram), when the S1 switches close, the S2 switches open and capacitors C1 and C2 charge up to V_I . On the second half of the cycle, C1 and C2 are connected in series between IN and OUT when the S1 switches open and S2 switches close. In the doubler mode only C2 is used. During one oscillator cycle, energy is transferred from the input to the charge pump capacitors, and then from the charge pump capacitors to the output capacitors and load. The number of cycles within a given time frame increases as the load increases or as the input supply voltage decreases. In the limiting case, the charge pumps operate continuously, and the oscillator frequency is nominally 500 kHz.

3.1 Shut down mode

The ST619LB enters low power shut down mode when SHDN is a logic high. In shut down mode, OUT is disconnected from the IN and V_O falls to 0V. The SHDN pin is connected to ground for normal operation. SHDN is a CMOS compatible input.

4 Maximum ratings

Table 3. Absolute maximum ratings

Symbol	Parameter	Value	Unit
V_I	DC input voltage	-0.3 to 5.5	V
V_O	Output voltage	-0.3 to 5.5	V
V_{SHDN}	Shutdown input voltage	-0.3 to ($V_I + 0.3$)	V
I_O	Output current continuous	120	mA
T_{STG}	Storage temperature range	-55 to +150	°C
T_{OP}	Operating junction temperature range	-40 to +85	°C

Note: Absolute maximum ratings are those values beyond which damage to the device may occur. Functional operation under these condition is not implied.

Table 4. Thermal data

Symbol	Parameter	SO-8	Unit
R_{thJA}	Thermal resistance junction-ambient ⁽¹⁾	160	°C/W

1. This value depends from thermal design of PCB on which the device is mounted.

5 Electrical characteristics

Table 5. Electrical characteristics ($V_I = 2$ to 3.6 V, $C_1 = C_2 = 0.22$ μ F, $C_3 = C_4 = 10$ μ F, $T_A = -40$ to 85° C, unless otherwise specified. Typical value are referred at $T_A = 25$ $^\circ$ C)

Symbol	Parameter	Test conditions	Min.	Typ.	Max.	Unit
V_I	Input voltage		2		3.6	V
V_O	Output voltage	$V_I = 2$ to 3.6 V, $I_O = 0$ to 20 mA	4.8	5	5.2	V
		$V_I = 3$ to 3.6 V, $I_O = 0$ to 30 mA	4.8	5	5.2	V
V_{RIPPLE}	Output voltage ripple	No load, Full load		100		mV
I_i	No load supply current	$V_I = 2$ to 3 V, No load		200	300	μ A
		$V_I = 3$ to 3.6 V, No load		75	150	
I_{SHDN}	Shutdown supply current	$V_I = 2$ to 3.6 V, No Load, $V_{SHDN} = V_I$		0.02	1	μ A
ν	Efficiency	$V_I = 3$ V, $I_O = 20$ mA		82		%
		$V_I = 3$ V, $I_O = 30$ mA		82		
		$V_I = 2$ V, $I_O = 20$ mA		80		
f_{OSC}	Switching frequency	Full load		500		kHz
V_{IH}	SHDN input threshold		$0.7V_I$			V
V_{IL}	SHDN input threshold				0.4	V
I_{IH}	SHDN input current	$V_{SHDN} = V_I$		0.005	± 1	μ A

Note: Do not overload or short the output to ground. If the above conditions are not observed the device may be damaged.

6 Typical performance characteristics

Figure 3. No load supply current vs input voltage

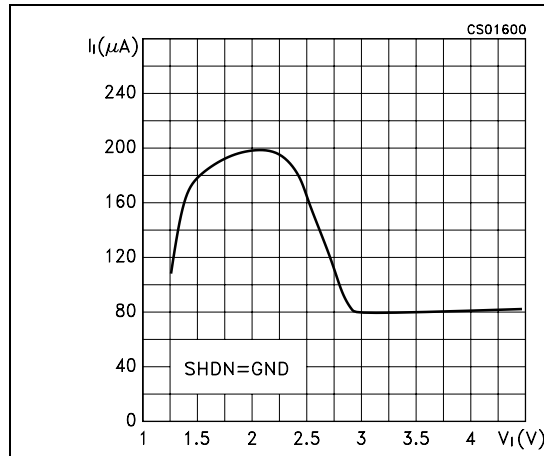

Figure 4. Shutdown supply current vs input voltage

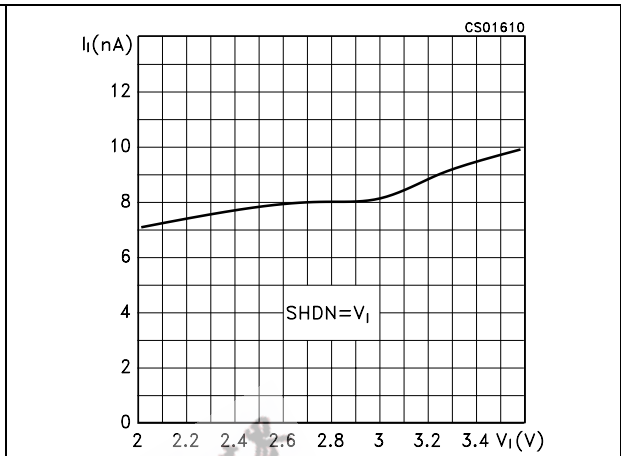

Figure 5. Maximum output current vs input voltage

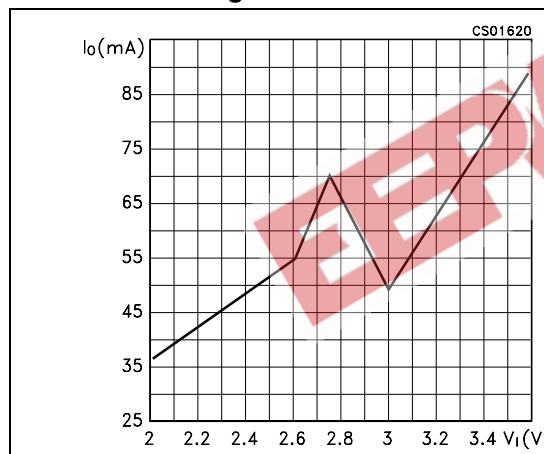

Figure 6. Output voltage vs output current

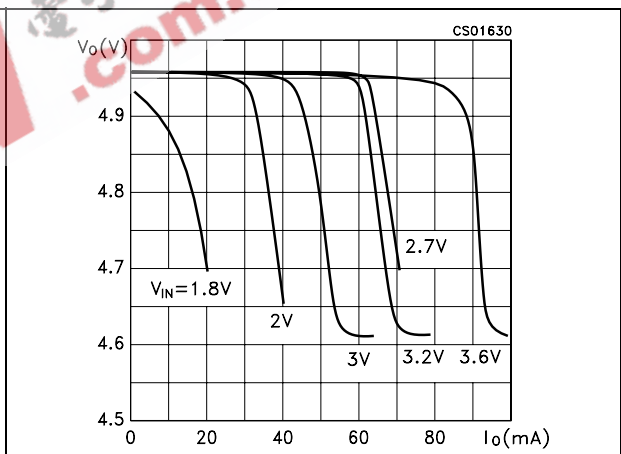

Figure 7. Efficiency vs output current

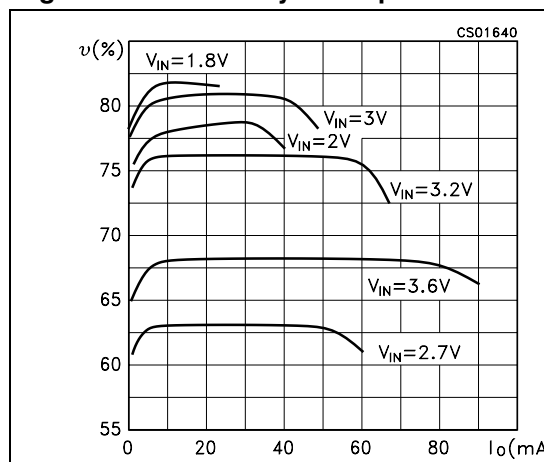

Figure 8. Efficiency vs input voltage

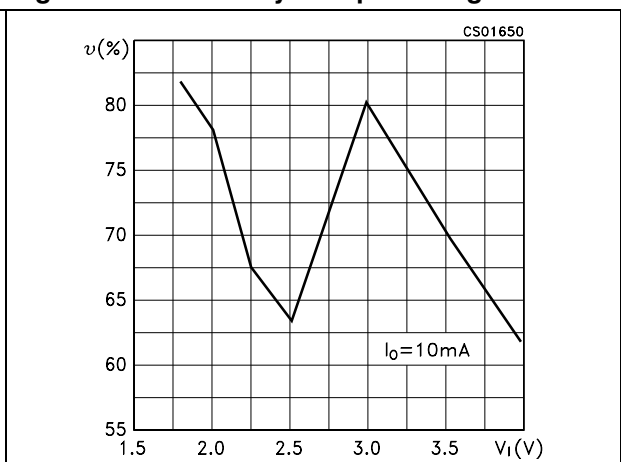

Figure 9. Output voltage vs input voltage

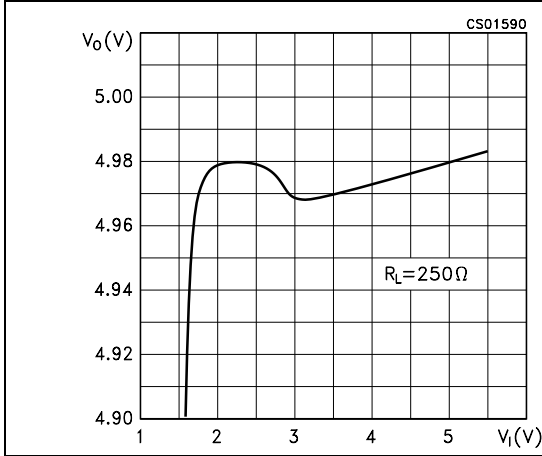

Figure 10. Start-up

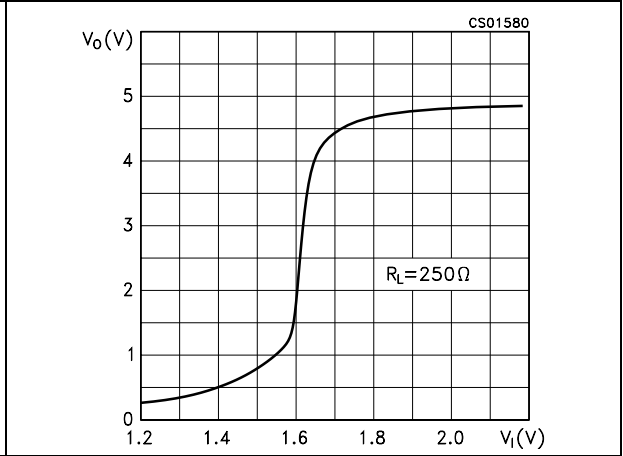

Figure 11. Output voltage vs temperature

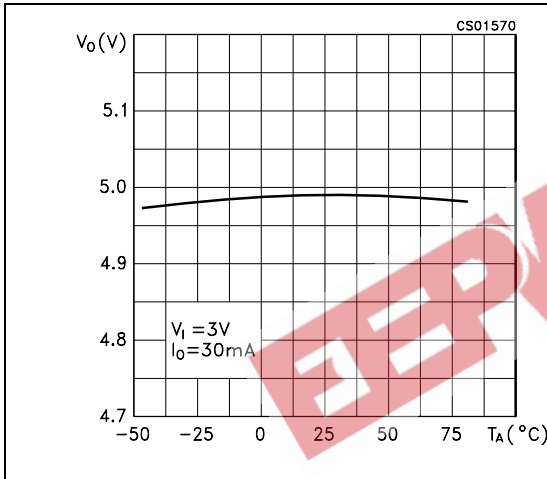

Figure 12. Line transient response

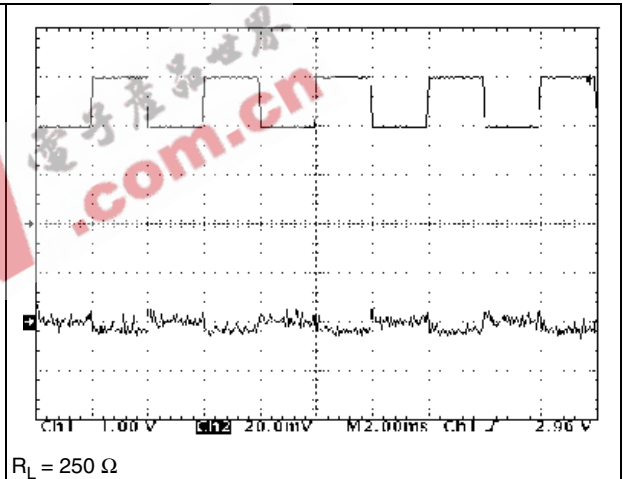
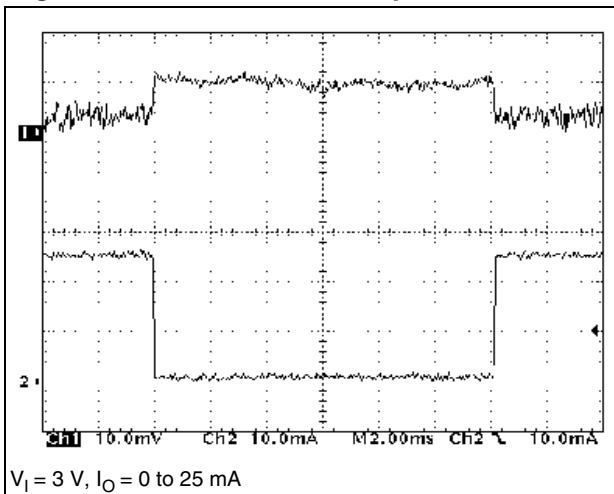

Figure 13. Load transient response



$V_i = 3\text{ V}, I_o = 0\text{ to }25\text{ mA}$

7 Application information

7.1 Charge pump capacitors C1 and C2

The values of charge pump capacitors C1 and C2 are critical to ensure adequate output current and avoid excessive peak currents. It is suggested to use values in the range of 0.22 μF to 1.0 μF and avoid the use of higher values of C_O capacitors, in order to obtain best performance. Ceramic or tantalum capacitors are recommended.

7.2 Input and output capacitors C3 and C4

The type of input capacitor (C3) and output filter capacitor (C4) used is not critical, but it does affect performance. Tantalum, ceramics or aluminium electrolytic are suggested. For lowest ripple, use large, low effective series resistance (ESR) ceramic tantalum capacitors. If the input supply source impedance is very low, C3 can be omitted. The typical application circuit shows the component values for proper operation using minimal board space. The input bypass capacitor (C3) and output filter capacitor (C4) should be at least 10 μF . Many capacitors exhibit 40% to 50% variation over temperature. Compensate for capacitor temperature coefficient by selecting a large nominal value to ensure proper operation over temperature.

7.3 Layout consideration

In the below figure, the typical application evaluation board of ST619LB is reported. A good layout ensures stability and helps maintain the output voltage under heavy loads. For best performance, use very short connections to the capacitors.

Figure 14. Typical application circuit

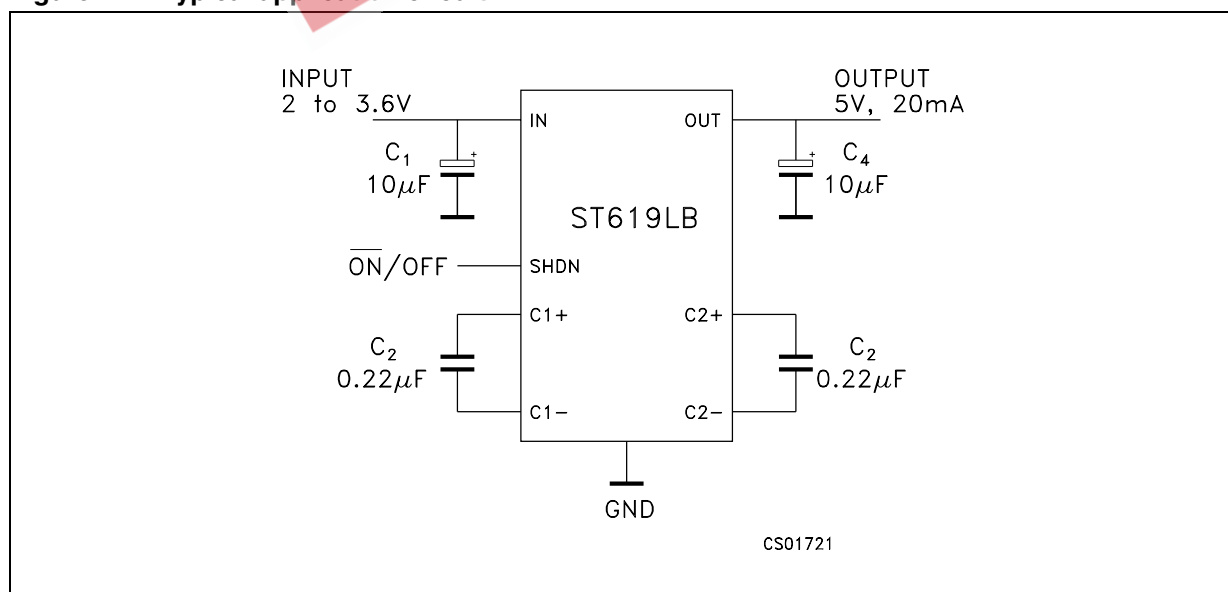
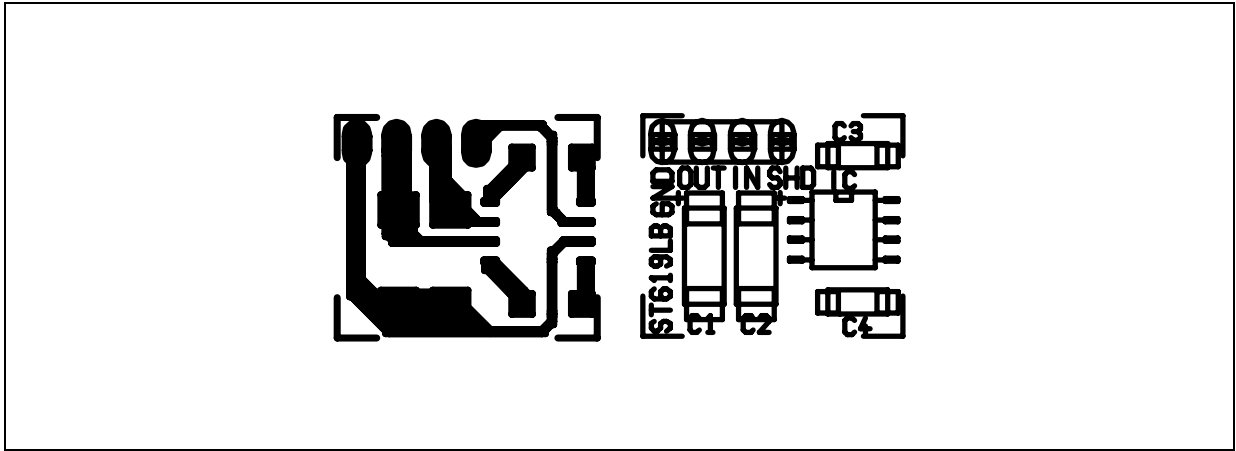

Figure 15. Typical application evaluation board



EEN.com.cn 电子产品世界 .com.cn

8 Package mechanical data

In order to meet environmental requirements, ST offers these devices in ECOPACK® packages. These packages have a Lead-free second level interconnect. The category of second Level Interconnect is marked on the package and on the inner box label, in compliance with JEDEC Standard JESD97. The maximum ratings related to soldering conditions are also marked on the inner box label. ECOPACK is an ST trademark. ECOPACK specifications are available at: www.st.com.

EEPW 电子產品世界
.com.cn

SO-8 mechanical data

Dim.	mm.			inch.		
	Min.	Typ.	Max.	Min.	Typ.	Max.
A	1.35		1.75	0.053		0.069
A1	0.10		0.25	0.04		0.010
A2	1.10		1.65	0.043		0.065
B	0.33		0.51	0.013		0.020
C	0.19		0.25	0.007		0.010
D	4.80		5.00	0.189		0.197
E	3.80		4.00	0.150		0.157
e		1.27			0.050	
H	5.80		6.20	0.228		0.244
h	0.25		0.50	0.010		0.020
L	0.40		1.27	0.016		0.050
k				8° (max.)		
ddd			0.1			0.04

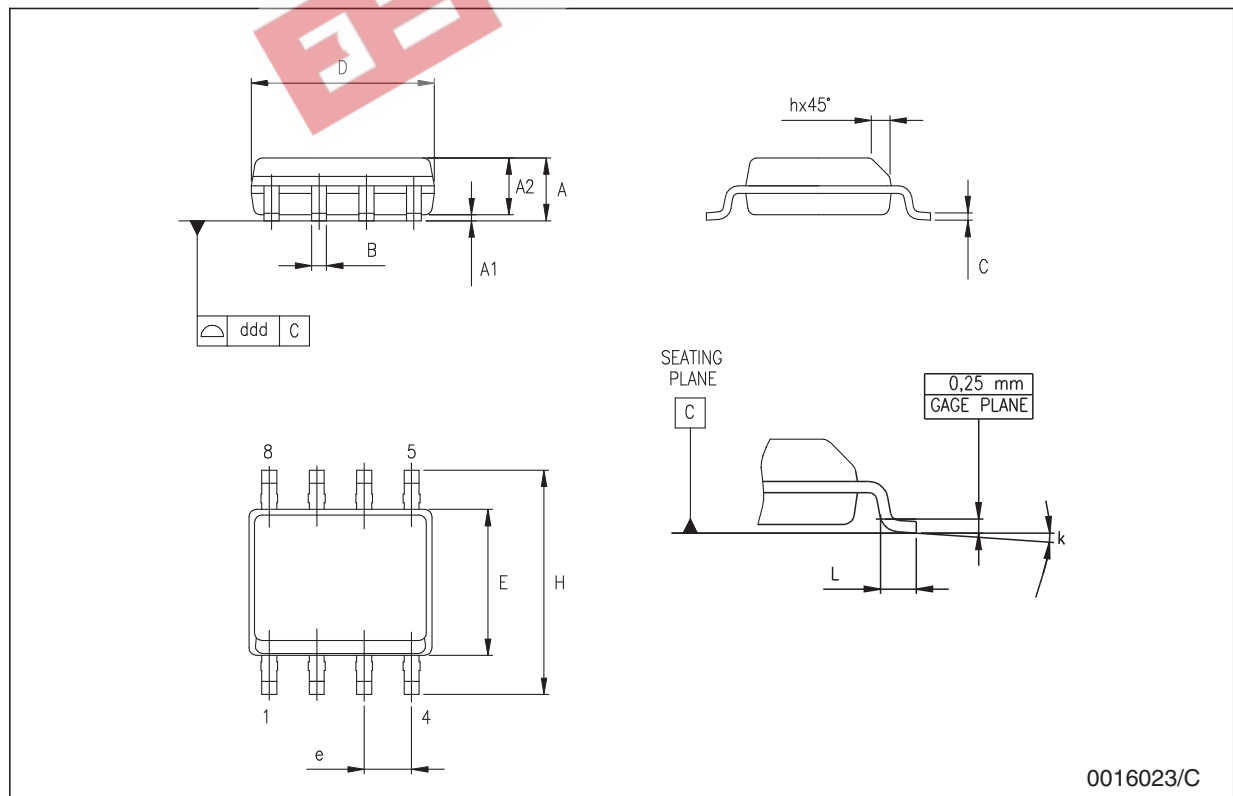

0016023/C

Tape & reel SO-8 mechanical data

Dim.	mm.			inch.		
	Min.	Typ.	Max.	Min.	Typ.	Max.
A			330			12.992
C	12.8		13.2	0.504		0.519
D	20.2			0.795		
N	60			2.362		
T			22.4			0.882
Ao	8.1		8.5	0.319		0.335
Bo	5.5		5.9	0.216		0.232
Ko	2.1		2.3	0.082		0.090
Po	3.9		4.1	0.153		0.161
P	7.9		8.1	0.311		0.319

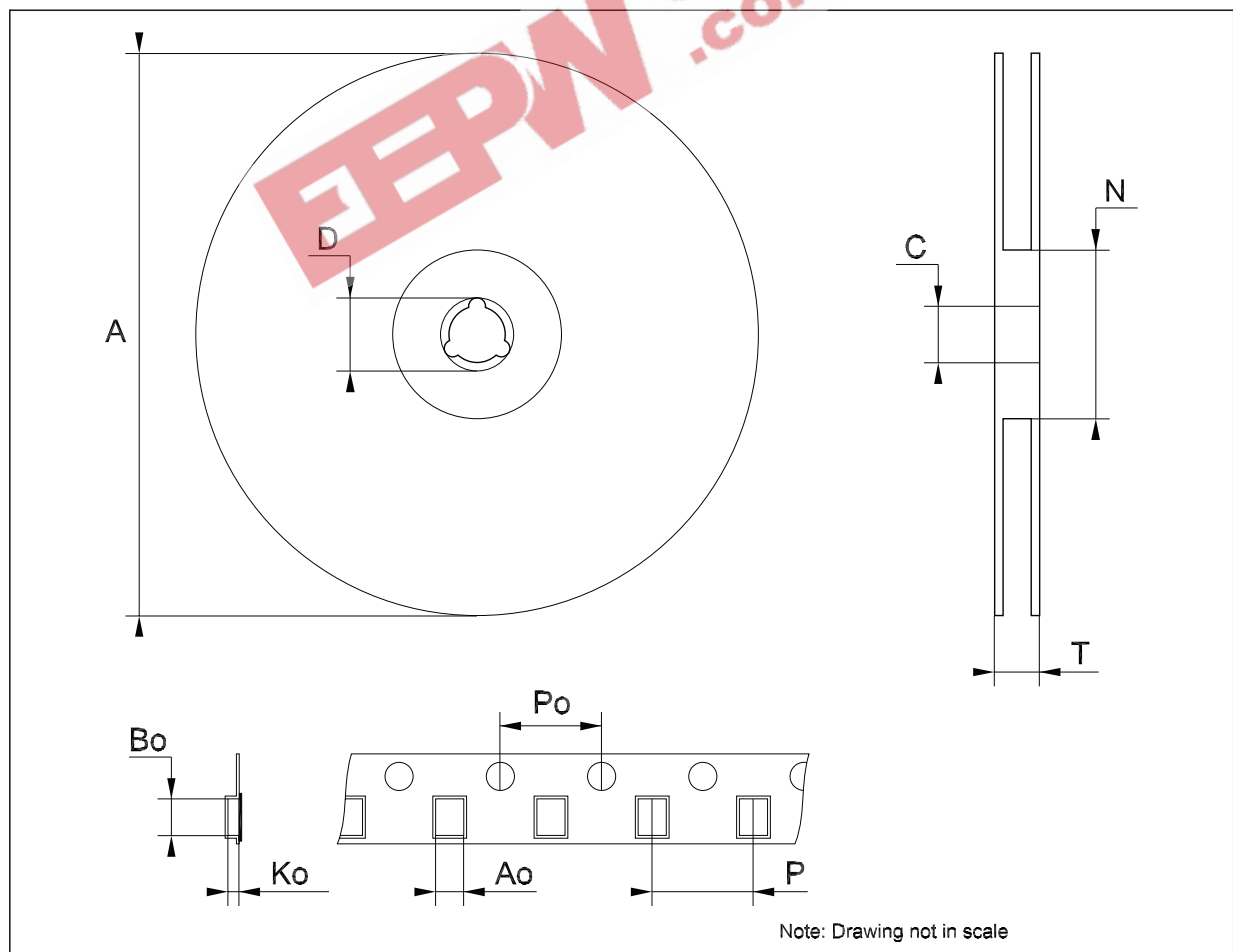

9 Revision history

Table 6. Document revision history

Date	Revision	Changes
21-Jun-2004	3	
07-Nov-2007	4	Added Table 1 .

EEPW 电子产品世界
.com.cn

Please Read Carefully:

Information in this document is provided solely in connection with ST products. STMicroelectronics NV and its subsidiaries ("ST") reserve the right to make changes, corrections, modifications or improvements, to this document, and the products and services described herein at any time, without notice.

All ST products are sold pursuant to ST's terms and conditions of sale.

Purchasers are solely responsible for the choice, selection and use of the ST products and services described herein, and ST assumes no liability whatsoever relating to the choice, selection or use of the ST products and services described herein.

No license, express or implied, by estoppel or otherwise, to any intellectual property rights is granted under this document. If any part of this document refers to any third party products or services it shall not be deemed a license grant by ST for the use of such third party products or services, or any intellectual property contained therein or considered as a warranty covering the use in any manner whatsoever of such third party products or services or any intellectual property contained therein.

UNLESS OTHERWISE SET FORTH IN ST'S TERMS AND CONDITIONS OF SALE ST DISCLAIMS ANY EXPRESS OR IMPLIED WARRANTY WITH RESPECT TO THE USE AND/OR SALE OF ST PRODUCTS INCLUDING WITHOUT LIMITATION IMPLIED WARRANTIES OF MERCHANTABILITY, FITNESS FOR A PARTICULAR PURPOSE (AND THEIR EQUIVALENTS UNDER THE LAWS OF ANY JURISDICTION), OR INFRINGEMENT OF ANY PATENT, COPYRIGHT OR OTHER INTELLECTUAL PROPERTY RIGHT.

UNLESS EXPRESSLY APPROVED IN WRITING BY AN AUTHORIZED ST REPRESENTATIVE, ST PRODUCTS ARE NOT RECOMMENDED, AUTHORIZED OR WARRANTED FOR USE IN MILITARY, AIR CRAFT, SPACE, LIFE SAVING, OR LIFE SUSTAINING APPLICATIONS, NOR IN PRODUCTS OR SYSTEMS WHERE FAILURE OR MALFUNCTION MAY RESULT IN PERSONAL INJURY, DEATH, OR SEVERE PROPERTY OR ENVIRONMENTAL DAMAGE. ST PRODUCTS WHICH ARE NOT SPECIFIED AS "AUTOMOTIVE GRADE" MAY ONLY BE USED IN AUTOMOTIVE APPLICATIONS AT USER'S OWN RISK.

Resale of ST products with provisions different from the statements and/or technical features set forth in this document shall immediately void any warranty granted by ST for the ST product or service described herein and shall not create or extend in any manner whatsoever, any liability of ST.

ST and the ST logo are trademarks or registered trademarks of ST in various countries.

Information in this document supersedes and replaces all information previously supplied.

The ST logo is a registered trademark of STMicroelectronics. All other names are the property of their respective owners.

© 2007 STMicroelectronics - All rights reserved

STMicroelectronics group of companies

Australia - Belgium - Brazil - Canada - China - Czech Republic - Finland - France - Germany - Hong Kong - India - Israel - Italy - Japan - Malaysia - Malta - Morocco - Singapore - Spain - Sweden - Switzerland - United Kingdom - United States of America

www.st.com