



# Micro-D Backshells EMI, Round Cable Entry, With Shield Sock, One Piece 500-011





**Shield Sock Backshells** save assembly time. These backshells are terminated to tinned copper braid in whatever length you require.

**Available in Top, 45° and Side Entry**, these backshells feature one piece construction and are available in a variety of plating finishes.

**Precision Swaged Braid Termination** adds mechanical strength and lowers resistance compared to hex crimps.

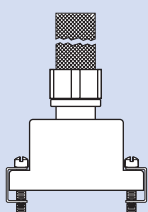
## HOW TO ORDER 500-011 SHIELD SOCK EMI BACKSHELLS

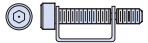
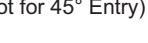
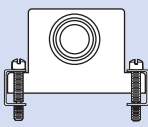
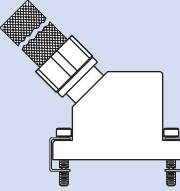
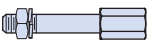
Series	Shell Finish	Connector Size	Hardware Option	Cable Entry Code	Length of Braid																																																	
<b>Top Entry</b> <b>500T011</b> 	<b>E</b> – Chem Film (Alodyne) <b>J</b> – Cadmium, Yellow Chromate <b>M</b> – Electroless Nickel <b>NF</b> – Cadmium, Olive Drab <b>Z2</b> – Gold	<b>09</b> <b>15</b> <b>21</b> <b>25</b> <b>31</b> <b>37</b> <b>51</b> <b>51-2</b> <b>67</b> <b>69</b> <b>100</b>	<b>B</b> – Fillister Head Jackscrew  <b>H</b> – Hex Head Jackscrew  <b>E</b> – Extended Jackscrew  (Not for 45° Entry)	<b>04</b> – .125 (3.2) <b>05</b> – .156 (4.0) <b>06</b> – .188 (4.8) <b>07</b> – .219 (5.6) <b>08</b> – .250 (6.4) <b>09</b> – .281 (7.1) <b>10</b> – .312 (7.9) <b>11</b> – .344 (8.7) <b>12</b> – .375 (9.5)	<b>Length in One Inch Increments</b>  Example: "6" equals six inches.																																																	
						<b>Side Entry</b> <b>500S011</b> 																																																
						<b>45° Entry</b> <b>500E011</b> 																																																
						<b>F</b> – Jackpost, Female 																																																
						<b>Maximum Cable Entry Code</b> <table border="1"> <thead> <tr> <th>Size</th> <th>T Top Entry</th> <th>E 45° Entry</th> <th>S Side Entry</th> </tr> </thead> <tbody> <tr><td>9</td><td>08</td><td>08</td><td>09</td></tr> <tr><td>15</td><td>08</td><td>08</td><td>12</td></tr> <tr><td>21</td><td>08</td><td>08</td><td>12</td></tr> <tr><td>25</td><td>08</td><td>08</td><td>12</td></tr> <tr><td>31</td><td>09</td><td>09</td><td>12</td></tr> <tr><td>37</td><td>09</td><td>09</td><td>12</td></tr> <tr><td>51</td><td>10</td><td>10</td><td>12</td></tr> <tr><td>51-2</td><td>09</td><td>09</td><td>12</td></tr> <tr><td>67</td><td>09</td><td>09</td><td>12</td></tr> <tr><td>69</td><td>10</td><td>10</td><td>12</td></tr> <tr><td>100</td><td>12</td><td>12</td><td>12</td></tr> </tbody> </table>	Size	T Top Entry	E 45° Entry	S Side Entry	9	08	08	09	15	08	08	12	21	08	08	12	25	08	08	12	31	09	09	12	37	09	09	12	51	10	10	12	51-2	09	09	12	67	09	09	12	69	10	10	12	100	12	12	12
						Size	T Top Entry	E 45° Entry	S Side Entry																																													
						9	08	08	09																																													
						15	08	08	12																																													
						21	08	08	12																																													
						25	08	08	12																																													
31	09	09	12																																																			
37	09	09	12																																																			
51	10	10	12																																																			
51-2	09	09	12																																																			
67	09	09	12																																																			
69	10	10	12																																																			
100	12	12	12																																																			
<b>Sample Part Number</b>																																																						
<b>500T011</b>	<b>– M</b>	<b>25</b>	<b>H</b>	<b>08</b>	<b>– 12</b>																																																	

# Micro-D Backshells EMI, Round Cable Entry, With Shield Sock, One Piece 500-011



## MATERIALS (SEE ORDERING INFO FOR FINISH OPTIONS)

Shell	Aluminum Alloy 6061 -T6 Per QQ-A-200, QQ-A-225 (Machined Components) Aluminum Alloy 6061-T6 Per QQ-A-591 (A380) (Die-Cast Components)
Braid	Tinned Copper Braid Per QQ-B-575 ASTM B33, #36 AWG Strands, 90% Coverage
Crimp Ring	Copper, Tin Plated
Clips, E-Rings	17-7PH Stainless Steel
Jackscrews, Washers, Jackposts	300 Series Stainless Steel, Passivated

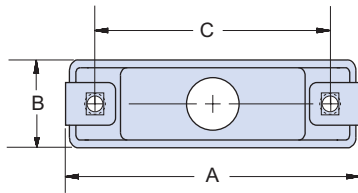

Cable Entry Code	F		G Max.	
	In. ±.010	mm. ±0.25	In.	mm.
04	.125	3.18	.310	7.87
05	.156	3.96	.350	8.89
06	.188	4.78	.380	9.65
07	.219	5.56	.400	10.16
08	.250	6.35	.425	13.31
09	.281	7.14	.450	11.43
10	.312	7.92	.500	12.70
11	.344	8.74	.525	13.34
12	.375	9.53	.550	13.97

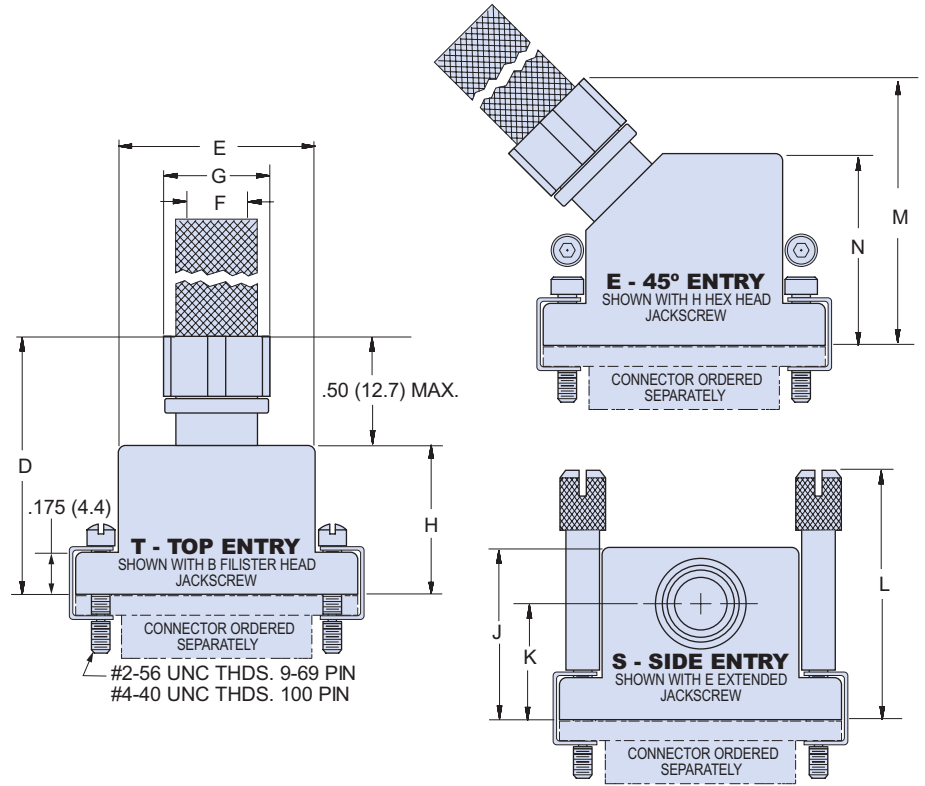

## SHIELD SOCK BACKSHELL DIMENSIONS – 500-011

Size	A Max.		B Max.		C		D Max.		E Max.		H Max.		J Max.		K		L Max.		M Max.		N Max.	
	In.	mm.	In.	mm.	In.	mm.	In.	mm.	In.	mm.	In.	mm.	In.	mm.	In.	mm.	In.	mm.	In.	mm.	In.	mm.
09	.850	21.59	.370	9.40	.565	14.35	.780	19.81	.410	10.41	.350	8.89	.637	16.18	.435	11.05	1.040	26.42	1.000	25.40	.680	17.27
15	1.000	25.40	.370	9.40	.715	18.16	.910	23.11	.580	14.73	.470	11.94	.673	17.09	.440	11.20	1.170	29.72	1.030	26.16	.730	18.54
21	1.150	29.21	.370	9.40	.865	21.97	1.030	26.16	.740	18.80	.590	14.99	.707	17.95	.458	11.63	1.290	32.77	1.050	26.67	.765	19.43
25	1.250	31.75	.370	9.40	.965	24.51	1.090	27.69	.850	21.59	.650	16.51	.748	19.00	.483	12.27	1.350	34.29	1.090	27.69	.830	21.08
31	1.400	35.56	.370	9.40	1.115	28.32	1.150	29.21	.980	24.89	.710	18.03	.756	19.20	.476	12.09	1.420	36.07	1.130	28.70	.890	22.61
37	1.550	39.37	.370	9.40	1.265	32.13	1.190	30.23	1.130	28.70	.750	19.05	.774	19.66	.478	12.14	1.450	36.83	1.230	31.24	.955	24.26
51	1.500	38.10	.410	10.41	1.215	30.86	1.220	30.99	1.080	27.43	.780	19.81	.859	21.82	.548	13.91	1.480	37.59	1.250	31.75	1.005	25.53
51-2	1.910	48.51	.370	9.40	1.615	41.02	1.220	30.99	1.510	38.35	.780	19.81	.859	21.82	.548	13.91	1.480	37.59	1.250	31.75	1.005	25.53
67	2.310	58.67	.370	9.40	2.015	51.18	1.220	30.99	1.880	47.75	.780	19.81	.859	21.82	.548	13.91	1.480	37.59	1.250	31.75	1.005	25.53
69	1.810	45.97	.410	10.41	1.515	38.48	1.220	30.99	1.380	35.05	.780	19.81	.859	21.82	.548	13.91	1.480	37.59	1.250	31.75	1.005	25.53
100	2.235	56.77	.460	11.68	1.800	45.72	1.280	32.51	1.470	37.34	.840	21.34	1.014	25.76	.687	17.45	1.580	40.13	1.320	33.53	1.080	27.43