

Type 500C 95 °C Long-Life, Screw Terminal, Aluminum Electrolytic

-40 °C to +95 °C, Long Life



Twice the Life!

Type 500C capacitors are designed for mainframe computers and other long life UPS and power supply filter applications. They deliver nearly as much capacitance as the Type DCMC capacitors, but with two times the life expectancy. They are an excellent choice for high ripple applications. The extended cathode foil of the 500C assures cool operation with heat flow from the capacitor element to the can.

Highlights

- Long-life, High-Capacitance
- Better for Power-supply and UPS systems
- Thermal-Pak™ extended cathode construction

Specifications

| | |
|------------------------------------|--|
| Operating Temperature: | -40 °C to +95 °C |
| Rated Voltage: | 6.3 to 500 Vdc |
| Capacitance: | 100 µF to 2.6 F |
| Capacitance Tolerance: | <200 Vdc: -10 +75%; ≥200 Vdc: -10% +50% |
| Leakage Current: | ≤3√CV µA at 5 minutes; 4 mA max. |
| Cold Impedance: | 20 °C multiple of 25 °C Z ≤20 for 6.3–10 V, 8 for 16–50 V, 4 for 63–100 V, 3 for 150 V and up. |
| Ripple Current Multipliers: | Ambient Temperature |

| 45 °C | 55 °C | 65 °C | 75 °C | 85 °C |
|-------|-------|-------|-------|-------|
| 2.00 | 1.82 | 1.59 | 1.33 | 1.00 |

Frequency

| | 50 Hz | 60 Hz | 120 Hz | 360 Hz | 1 kHz | 5 kHz | 10 kHz & up |
|--------------------------------------|-------|-------|--------|--------|-------|-------|-------------|
| 1 3/8" & 1 3/4" Diameters | | | | | | | |
| 6.3 to 160 V | 0.91 | 0.93 | 1.00 | 1.06 | 1.08 | 1.10 | 1.10 |
| 200 to 350 V | 0.76 | 0.81 | 1.00 | 1.24 | 1.36 | 1.43 | 1.44 |
| 400 to 500 Vx | 0.76 | 0.81 | 1.00 | 1.24 | 1.37 | 1.44 | 1.45 |
| 2" & 2 1/2" Diameters | | | | | | | |
| 6.3 to 160 V | 0.93 | 0.95 | 1.00 | 1.04 | 1.06 | 1.06 | 1.07 |
| 200 to 350 V | 0.78 | 0.83 | 1.00 | 1.20 | 1.29 | 1.34 | 1.35 |
| 400 to 500 V | 0.77 | 0.82 | 1.00 | 1.22 | 1.33 | 1.39 | 1.40 |
| 3" & 3 1/2" Diameters | | | | | | | |
| 6.3 to 160 V | 0.95 | 0.97 | 1.00 | 1.03 | 1.04 | 1.04 | 1.04 |
| 200 to 350 V | 0.84 | 0.88 | 1.00 | 1.12 | 1.17 | 1.20 | 1.20 |
| 400 to 500 V | 0.79 | 0.84 | 1.00 | 1.18 | 1.26 | 1.31 | 1.32 |



Complies with the EU Directive 2002/95/EC requirement restricting the use of Lead (Pb), Mercury (Hg), Cadmium (Cd), Hexavalent chromium (Cr(VI)), PolyBrominated Biphenyls (PBB) and PolyBrominated Diphenyl Ethers (PBDE).

EIA Ripple Life: 5,000 h at full load @ +85 °C per EIA IS-749

ΔCapacitance ±20%
ESR 200% of limit
DCL 100% of limit

Life Test: 5,000 h at 95 °C and rated voltage
ΔCapacitance ±20%
ESR 200% of limit
DCL 100% of limit

Shelf Life: 500 h @ +95 °C, Capacitance, ESR and DCL, initial requirements.

Vibration: 10 to 55 Hz, 0.06" and 10 g max, 1.5 h ea. of 2 axis

Type 500C 95 °C Long-Life, Screw Terminal, Aluminum Electrolytic

Outline Drawings

Case Dimensions Uninsulated Case Dimensions

For insulated case, add 0.024”(0.610 mm) to “D”and 0.030”(0.762 mm) to height.

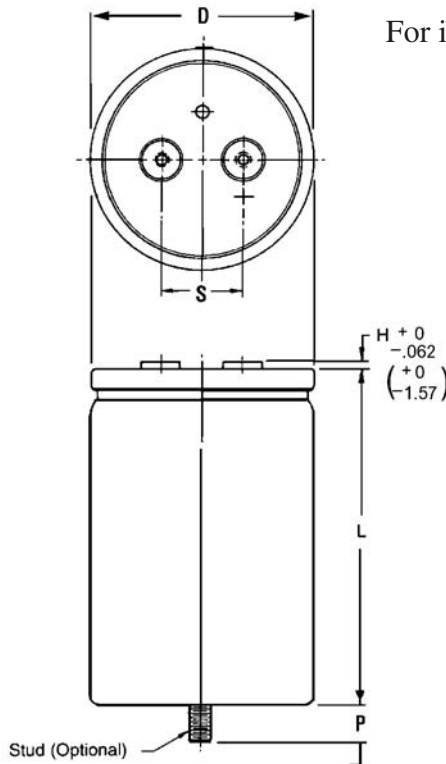

NOTE: With the stud-mount feature, a thermally-conductive disk can be inserted in the bottom flush with the outer insulating sleeve. This reduces the thermal resistance through the can bottom by 0.3 °C/W. Can Style P.

Stud Dimensions

| Case Diam. | Stud Thread | P ± 0.039” (±1.0 mm) |
|------------|-------------|----------------------|
| 1.38 | M8 | 0.470” (12.0) |
| 1.75 | M8 | 0.470” (12.0) |
| 2.00 | M12 | 0.630” (16.0) |
| 2.50 | M12 | 0.630” (16.0) |
| 3.00 | M12 | 0.630” (16.0) |
| 3.50 | M12 | 0.630” (16.0) |

Terminal Dimensions

| Terminal Style | For Case Diameters | Code | Post Diameter | | H max | | Thread | min Full Thread | | Torque | |
|--------------------|--------------------|------|---------------|------|-------|-----|--------|-----------------|------|--------|------|
| | | | in | mm | in | mm | | in | mm | in-lb | N-m |
| Low Post | 1½ to 3 | A | 0.314 | 8.0 | 0.094 | 2.4 | 10-32 | 0.218 | 5.5 | 25 | 2.82 |
| High Post | 1½ to 3 | B | 0.314 | 8.0 | 0.281 | 7.1 | 10-32 | 0.375 | 9.5 | 25 | 2.82 |
| High Current, Low | 2½ to 3½ | D | 0.684 | 17.4 | 0.125 | 3.2 | ¼-28 | 0.344 | 8.7 | 60 | 6.78 |
| High Current, High | 2½ to 3½ | E | 0.684 | 17.4 | 0.281 | 7.1 | ¼-28 | 0.469 | 11.9 | 60 | 6.78 |
| M5 Post, Small | 1½ to 2 | M | 0.314 | 8.0 | 0.281 | 7.1 | M5 | 0.375 | 9.5 | 25 | 2.82 |
| M5 Post | 2½ & 3 | F | 0.512 | 13.0 | 0.230 | 5.8 | M5 | 0.344 | 8.7 | 25 | 2.82 |
| M6 Low Post | 2½ to 3½ | G | 0.684 | 17.4 | 0.125 | 3.2 | M6 | 0.344 | 8.7 | 60 | 6.78 |
| M6 High Post | 2½ to 3½ | H | 0.684 | 17.4 | 0.281 | 7.1 | M6 | 0.469 | 11.9 | 60 | 6.78 |

NOTE: Only high post and M5 post terminals are available at 550 Vdc as they meet the required creepage distance.

[Click here to see Hardware & Mounting Options](#)

| Case Code | Diam. (D) | | Length (L) | | Terminals (S) | | Typical Weight | |
|-----------|--------------|---------|--------------|----------|---------------|---------|----------------|------|
| | ±.031 Inches | ±.78 mm | ±.062 Inches | ±1.57 mm | ±0.015 Inches | ±.38 mm | oz | g |
| AK | 1.375 | 34.93 | 1.625 | 41.28 | 0.50 | 12.70 | 1.9 | 54 |
| AA | 1.375 | 34.93 | 2.125 | 53.98 | 0.50 | 12.70 | 2.0 | 57 |
| AH | 1.375 | 34.93 | 2.625 | 66.68 | 0.50 | 12.70 | 2.7 | 77 |
| AB | 1.375 | 34.93 | 3.125 | 79.38 | 0.50 | 12.70 | 3.3 | 94 |
| AJ | 1.375 | 34.93 | 3.625 | 92.08 | 0.50 | 12.70 | 3.8 | 108 |
| AC | 1.375 | 34.93 | 4.125 | 104.78 | 0.50 | 12.70 | 4.4 | 125 |
| AD | 1.375 | 34.93 | 4.625 | 117.48 | 0.50 | 12.70 | 5.1 | 145 |
| AE | 1.375 | 34.93 | 5.125 | 130.18 | 0.50 | 12.70 | 6.8 | 193 |
| AF | 1.375 | 34.93 | 5.625 | 142.88 | 0.50 | 12.70 | 8.1 | 230 |
| EA | 1.750 | 44.45 | 2.125 | 53.98 | 0.75 | 19.05 | 2.7 | 76 |
| EH | 1.750 | 44.45 | 2.625 | 66.68 | 0.75 | 19.05 | 3.8 | 108 |
| EB | 1.750 | 44.45 | 3.125 | 79.38 | 0.75 | 19.05 | 5.1 | 145 |
| EJ | 1.750 | 44.45 | 3.625 | 92.08 | 0.75 | 19.05 | 6.8 | 193 |
| EC | 1.750 | 44.45 | 4.125 | 104.78 | 0.75 | 19.05 | 8.1 | 230 |
| ED | 1.750 | 44.45 | 4.625 | 117.48 | 0.75 | 19.05 | 9.0 | 255 |
| EE | 1.750 | 44.45 | 5.125 | 130.18 | 0.75 | 19.05 | 9.5 | 269 |
| EF | 1.750 | 44.45 | 5.625 | 142.88 | 0.75 | 19.05 | 10.5 | 298 |
| BA | 2.000 | 50.80 | 2.125 | 53.98 | 0.88 | 22.23 | 5.4 | 153 |
| BH | 2.000 | 50.80 | 2.625 | 66.68 | 0.88 | 22.23 | 6.1 | 173 |
| BB | 2.000 | 50.80 | 3.125 | 79.38 | 0.88 | 22.23 | 6.8 | 193 |
| BJ | 2.000 | 50.80 | 3.625 | 92.08 | 0.88 | 22.23 | 8.2 | 232 |
| BC | 2.000 | 50.80 | 4.125 | 104.78 | 0.88 | 22.23 | 9.5 | 269 |
| BD | 2.000 | 50.80 | 4.625 | 117.48 | 0.88 | 22.23 | 10.3 | 292 |
| BE | 2.000 | 50.80 | 5.125 | 130.18 | 0.88 | 22.23 | 10.7 | 303 |
| BF | 2.000 | 50.80 | 5.625 | 142.88 | 0.88 | 22.23 | 13.0 | 369 |
| CH | 2.500 | 63.50 | 2.625 | 66.68 | 1.13 | 28.58 | 9.2 | 261 |
| CB | 2.500 | 63.50 | 3.125 | 79.38 | 1.13 | 28.58 | 10.4 | 295 |
| CJ | 2.500 | 63.50 | 3.625 | 92.08 | 1.13 | 28.58 | 12.7 | 361 |
| CC | 2.500 | 63.50 | 4.125 | 104.78 | 1.13 | 28.58 | 15.0 | 425 |
| CD | 2.500 | 63.50 | 4.625 | 117.48 | 1.13 | 28.58 | 17.2 | 488 |
| CE | 2.500 | 63.50 | 5.125 | 130.18 | 1.13 | 28.58 | 19.3 | 547 |
| CF | 2.500 | 63.50 | 5.625 | 142.88 | 1.13 | 28.58 | 21.4 | 607 |
| DB | 3.000 | 76.20 | 3.125 | 79.38 | 1.25 | 31.75 | 16.7 | 473 |
| DJ | 3.000 | 76.20 | 3.625 | 92.08 | 1.25 | 31.75 | 20.0 | 567 |
| DC | 3.000 | 76.20 | 4.125 | 104.78 | 1.25 | 31.75 | 22.2 | 629 |
| DD | 3.000 | 76.20 | 4.625 | 117.48 | 1.25 | 31.75 | 25.5 | 723 |
| DE | 3.000 | 76.20 | 5.125 | 130.18 | 1.25 | 31.75 | 30.0 | 850 |
| DF | 3.000 | 76.20 | 5.625 | 142.88 | 1.25 | 31.75 | 31.9 | 904 |
| DP | 3.000 | 76.20 | 5.875 | 149.23 | 1.25 | 31.75 | 32.8 | 931 |
| DN | 3.000 | 76.20 | 7.625 | 193.68 | 1.25 | 31.75 | 39.5 | 1119 |
| DG | 3.000 | 76.20 | 8.625 | 219.08 | 1.25 | 31.75 | 43.3 | 1227 |
| FC | 3.500 | 88.90 | 4.125 | 104.78 | 1.25 | 31.75 | 30.0 | 850 |
| FD | 3.500 | 88.90 | 4.625 | 117.48 | 1.25 | 31.75 | 34.4 | 976 |
| FE | 3.500 | 88.90 | 5.125 | 130.18 | 1.25 | 31.75 | 40.5 | 1148 |
| FF | 3.500 | 88.90 | 5.625 | 142.88 | 1.25 | 31.75 | 43.1 | 1221 |
| FP | 3.500 | 88.90 | 5.875 | 149.23 | 1.25 | 31.75 | 44.3 | 1257 |
| FN | 3.500 | 88.90 | 7.625 | 193.68 | 1.25 | 31.75 | 53.3 | 1512 |
| FG | 3.500 | 88.90 | 8.625 | 219.08 | 1.25 | 31.75 | 58.5 | 1658 |

Type 500C 95 °C Long-Life, Screw Terminal, Aluminum Electrolytic

Part Numbering System

| | | | | | | | |
|-------------|---|------------------------------------|--|------------------|-----------------------------------|--|---|
| 500C | 492 | U | 063 | AA | 2 | B | S |
| Type | Capacitance | Tolerance | Voltage | Case Code | Insulation | Terminal | Can Style |
| 500C | 100 = 10 μ F 101 = 100 μ F 492 = 4900 μ F 433 = 43,000 μ F | M= 20% U= 10%+75% T= 10%+50% | 6R3 = 6.3 Vdc 063 = 63 Vdc 100 = 100 Vdc | | 0= None 1= Polyester 2= PVC | A= Low Post B= High Post D= High Current, Low Post E= High Current, High Post F or M= M5 Post G= M6 Low Post H= M6 High Post | Blank = Standard Can S = Stud Bottom P = Stud with Thermal Pad |

Standard insulation is 0.008-in PVC sleeve with 0.01-in polypropylene end disk.
Polyester insulation is not available for 3.5 inch diameter units.

Typical Performance Curves

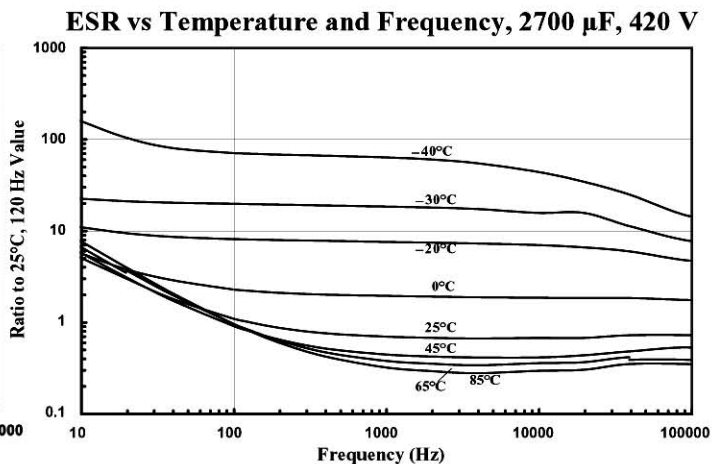
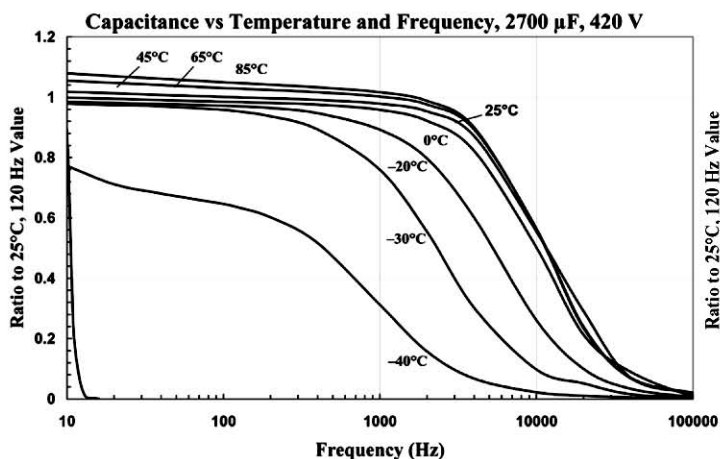
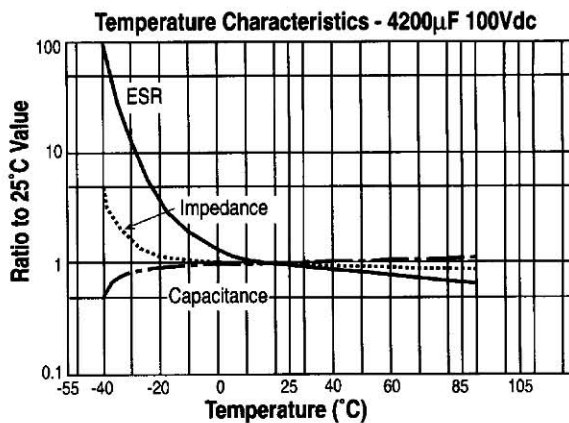
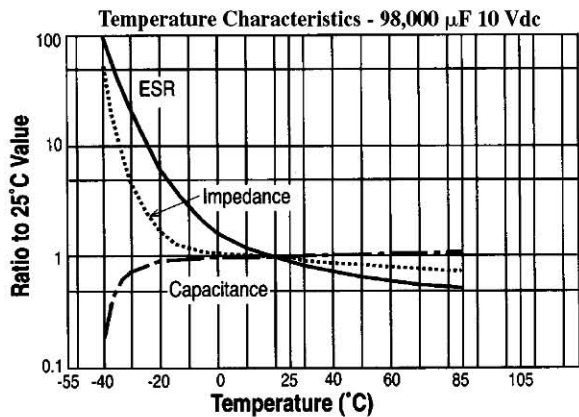
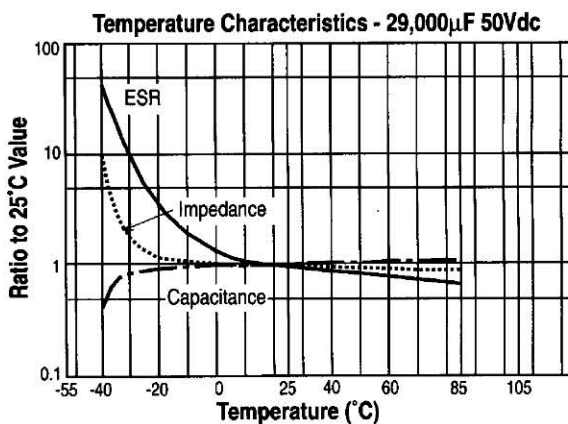
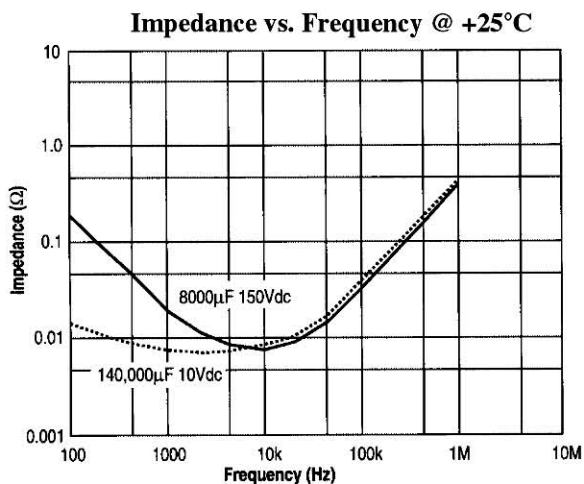

Type 500C 95 °C Long-Life, Screw Terminal, Aluminum Electrolytic

Typical Performance Curves

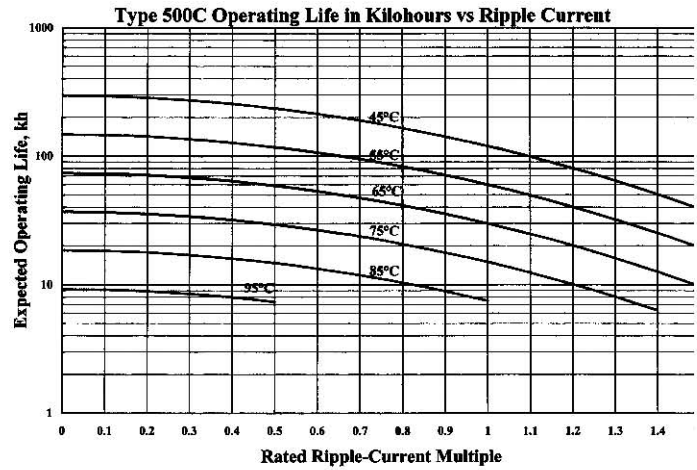
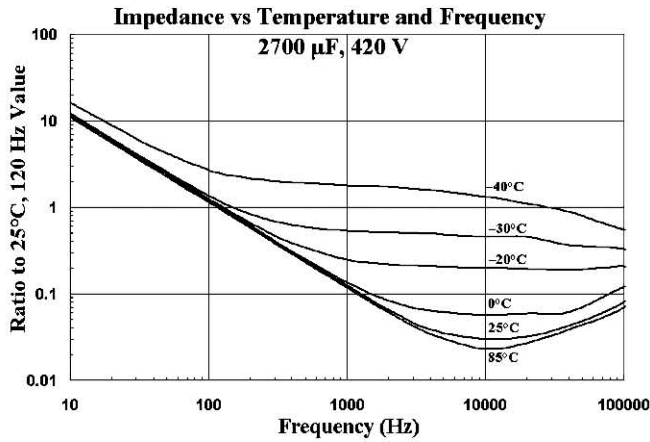

Ratings

| Cap. (µF) | Catalog Part Number | ESR Max. @ 25 °C 120 Hz (mΩ) | Ripple Max. @ 85°C 120 Hz (A) | Nominal Size D x L (inches) |
|------------------------------|---------------------|------------------------------|-------------------------------|-----------------------------|
| 6.3 Vdc (8 Vdc Surge) | | | | |
| 27000 | 500C273U6R3AK2B | 46.9 | 4.70 | 1 3/8 x 1 5/8 |
| 55000 | 500C553U6R3AA2B | 26.5 | 6.90 | 1 3/8 x 2 1/8 |
| 66000 | 500C663U6R3AH2B | 18.8 | 8.90 | 1 3/8 x 2 5/8 |
| 87000 | 500C873U6R3AB2B | 14.7 | 10.70 | 1 3/8 x 3 1/8 |
| 96000 | 500C963U6R3EA2B | 18.8 | 9.60 | 1 3/4 x 2 1/8 |
| 110000 | 500C114U6R3AJ2B | 12.8 | 12.10 | 1 3/8 x 3 5/8 |
| 120000 | 500C124U6R3EH2B | 14.3 | 11.80 | 1 3/4 x 2 5/8 |
| 120000 | 500C124U6R3BA2B | 14.2 | 12.00 | 2 x 2 1/8 |
| 130000 | 500C134U6R3AC2B | 11.0 | 13.70 | 1 3/8 x 4 1/8 |
| 140000 | 500C144U6R3BH2B | 9.9 | 15.50 | 2 x 2 5/8 |
| 150000 | 500C154U6R3AD2B | 9.8 | 15.20 | 1 3/8 x 4 5/8 |
| 160000 | 500C164U6R3EB2B | 11.0 | 14.30 | 1 3/4 x 3 1/8 |
| 170000 | 500C174U6R3AE2B | 8.9 | 16.50 | 1 3/8 x 5 1/8 |
| 190000 | 500C194U6R3AF2B | 8.3 | 17.80 | 1 3/8 x 5 5/8 |
| 190000 | 500C194U6R3EJ2B | 9.1 | 16.60 | 1 3/4 x 3 5/8 |
| 200000 | 500C204U6R3BB2B | 7.8 | 18.40 | 2 x 3 1/8 |
| 230000 | 500C234U6R3EC2B | 7.9 | 18.70 | 1 3/4 x 4 1/8 |
| 250000 | 500C254U6R3BJ2B | 6.5 | 21.40 | 2 x 3 5/8 |
| 250000 | 500C254U6R3CH2B | 6.9 | 21.20 | 2 1/2 x 2 5/8 |
| 270000 | 500C274U6R3ED2B | 7.0 | 20.60 | 1 3/4 x 4 5/8 |
| 300000 | 500C304U6R3BC2B | 5.6 | 24.10 | 2 x 4 1/8 |
| 310000 | 500C314U6R3EE2B | 6.4 | 22.40 | 1 3/4 x 5 1/8 |
| 340000 | 500C344U6R3CB2B | 5.3 | 25.80 | 2 1/2 x 3 1/8 |
| 350000 | 500C354U6R3EF2B | 6.0 | 24.00 | 1 3/4 x 5 5/8 |
| 360000 | 500C364U6R3BD2B | 5.0 | 26.60 | 2 x 4 5/8 |
| 410000 | 500C414U6R3BE2B | 4.5 | 28.80 | 2 x 5 1/8 |
| 420000 | 500C424U6R3CJ2B | 4.3 | 29.90 | 2 1/2 x 3 5/8 |
| 450000 | 500C454U6R3BF2D | 4.2 | 30.90 | 2 x 5 5/8 |
| 500000 | 500C504U6R3DB2D | 4.1 | 32.90 | 3 x 3 1/8 |

| Cap. (µF) | Catalog Part Number | ESR Max. @ 25 °C 120 Hz (mΩ) | Ripple Max. @ 85°C 120 Hz (A) | Nominal Size D x L (inches) |
|------------------------------|---------------------|------------------------------|-------------------------------|-----------------------------|
| 510000 | 500C514U6R3CC2D | 3.8 | 33.40 | 2 1/2 x 4 1/8 |
| 580000 | 500C584U6R3CD2D | 3.4 | 36.80 | 2 1/2 x 4 5/8 |
| 620000 | 500C624U6R3DJ2D | 3.3 | 38.20 | 3 x 3 5/8 |
| 680000 | 500C684U6R3CE2D | 3.1 | 40.00 | 2 1/2 x 5 1/8 |
| 740000 | 500C744U6R3DC2D | 2.9 | 42.50 | 3 x 4 1/8 |
| 760000 | 500C764U6R3CF2D | 2.8 | 42.90 | 2 1/2 x 5 5/8 |
| 880000 | 500C884U6R3DD2D | 2.6 | 46.70 | 3 x 4 5/8 |
| 980000 | 500C984U6R3DE2D | 2.4 | 50.60 | 3 x 5 1/8 |
| 1100000 | 500C115U6R3DF2D | 2.4 | 51.30 | 3 x 5 5/8 |
| 1100000 | 500C115U6R3FC2D | 3.0 | 46.40 | 3 1/2 x 4 1/8 |
| 1100000 | 500C115U6R3FD2D | 2.6 | 51.00 | 3 1/2 x 4 5/8 |
| 1200000 | 500C125U6R3DP2D | 2.4 | 52.00 | 3 x 5 7/8 |
| 1400000 | 500C145U6R3FE2D | 2.4 | 55.40 | 3 1/2 x 5 1/8 |
| 1600000 | 500C165U6R3FF2D | 2.4 | 56.10 | 3 1/2 x 5 5/8 |
| 1600000 | 500C165U6R3DN2D | 2.6 | 55.90 | 3 x 7 5/8 |
| 1700000 | 500C175U6R3FP2D | 2.4 | 57.00 | 3 1/2 x 5 7/8 |
| 1800000 | 500C185U6R3DG2D | 2.4 | 58.60 | 3 x 8 5/8 |
| 2300000 | 500C235U6R3FN2D | 2.4 | 61.70 | 3 1/2 x 7 5/8 |
| 2600000 | 500C265U6R3FG2D | 2.4 | 64.40 | 3 1/2 x 8 5/8 |
| 10 Vdc (12 Vdc Surge) | | | | |
| 22000 | 500C223U010AK2B | 46.9 | 4.70 | 1 3/8 x 1 5/8 |
| 39000 | 500C393U010AA2B | 26.5 | 6.90 | 1 3/8 x 2 1/8 |
| 52000 | 500C523U010AH2B | 20.1 | 8.60 | 1 3/8 x 2 5/8 |
| 70000 | 500C703U010AB2B | 15.5 | 10.50 | 1 3/8 x 3 1/8 |
| 71000 | 500C713U010EA2B | 18.8 | 9.60 | 1 3/4 x 2 1/8 |
| 87000 | 500C873U010AJ2B | 12.8 | 12.10 | 1 3/8 x 3 5/8 |
| 95000 | 500C953U010EH2B | 14.3 | 11.80 | 1 3/4 x 2 5/8 |
| 100000 | 500C104U010AC2B | 11.0 | 13.70 | 1 3/8 x 4 1/8 |
| 100000 | 500C104U010BA2B | 17.6 | 10.70 | 2 x 2 1/8 |
| 120000 | 500C124U010AD2B | 9.8 | 15.20 | 1 3/8 x 4 5/8 |

Type 500C 95 °C Long-Life, Screw Terminal, Aluminum Electrolytic

| Cap. (µF) | Catalog Part Number | ESR Max. @ 25 °C 120 Hz (mΩ) | Ripple Max. @ 85°C 120 Hz (A) | Nominal Size D x L (inches) |
|------------------------------|---------------------|------------------------------|-------------------------------|-----------------------------|
| 130000 | 500C134U010EB2B | 11.0 | 14.30 | 1 3/4 x 3 1/8 |
| 130000 | 500C134U010BH2B | 13.4 | 13.30 | 2 x 2 5/8 |
| 140000 | 500C144U010AE2B | 8.9 | 16.50 | 1 3/8 x 5 1/8 |
| 160000 | 500C164U010AF2B | 8.3 | 17.80 | 1 3/8 x 5 5/8 |
| 160000 | 500C164U010EJ2B | 9.1 | 16.60 | 1 3/4 x 3 5/8 |
| 160000 | 500C164U010BB2B | 10.5 | 16.00 | 2 x 3 1/8 |
| 190000 | 500C194U010EC2B | 7.9 | 18.70 | 1 3/4 x 4 1/8 |
| 200000 | 500C204U010BJ2B | 8.7 | 18.50 | 2 x 3 5/8 |
| 200000 | 500C204U010CH2B | 8.8 | 18.90 | 2 1/2 x 2 5/8 |
| 220000 | 500C224U010ED2B | 7.0 | 20.60 | 1 3/4 x 4 5/8 |
| 240000 | 500C244U010BC2B | 7.5 | 20.80 | 2 x 4 1/8 |
| 250000 | 500C254U010EE2B | 6.4 | 22.40 | 1 3/4 x 5 1/8 |
| 270000 | 500C274U010CB2B | 6.7 | 22.90 | 2 1/2 x 3 1/8 |
| 280000 | 500C284U010EF2B | 6.0 | 24.00 | 1 3/4 x 5 5/8 |
| 280000 | 500C284U010BD2B | 6.7 | 22.90 | 2 x 4 5/8 |
| 320000 | 500C324U010BE2B | 6.1 | 24.80 | 2 x 5 1/8 |
| 340000 | 500C344U010CJ2B | 5.5 | 26.50 | 2 1/2 x 3 5/8 |
| 360000 | 500C364U010BF2B | 5.7 | 26.50 | 2 x 5 5/8 |
| 400000 | 500C404U010DB2D | 4.1 | 32.90 | 3 x 3 1/8 |
| 410000 | 500C414U010CC2B | 4.8 | 29.60 | 2 1/2 x 4 1/8 |
| 480000 | 500C484U010CD2D | 4.3 | 32.60 | 2 1/2 x 4 5/8 |
| 500000 | 500C504U010DJ2D | 3.3 | 38.20 | 3 x 3 5/8 |
| 550000 | 500C554U010CE2D | 3.9 | 35.30 | 2 1/2 x 5 1/8 |
| 600000 | 500C604U010DC2D | 2.9 | 42.50 | 3 x 4 1/8 |
| 610000 | 500C614U010CF2D | 3.6 | 37.90 | 2 1/2 x 5 5/8 |
| 700000 | 500C704U010DD2D | 2.6 | 46.70 | 3 x 4 5/8 |
| 800000 | 500C804U010DE2D | 2.4 | 50.60 | 3 x 5 1/8 |
| 830000 | 500C834U010FC2D | 2.9 | 47.30 | 3 1/2 x 4 1/8 |
| 870000 | 500C874U010DF2D | 2.3 | 53.00 | 3 x 5 5/8 |
| 930000 | 500C934U010DP2D | 2.3 | 53.30 | 3 x 5 7/8 |
| 970000 | 500C974U010FD2D | 2.8 | 49.60 | 3 1/2 x 4 5/8 |
| 1100000 | 500C115U010FE2D | 2.5 | 54.50 | 3 1/2 x 5 1/8 |
| 1200000 | 500C125U010FF2D | 2.2 | 59.00 | 3 1/2 x 5 5/8 |
| 1300000 | 500C135U010FP2D | 2.1 | 60.80 | 3 1/2 x 5 7/8 |
| 1300000 | 500C135U010DN2D | 2.1 | 60.10 | 3 x 7 5/8 |
| 1500000 | 500C155U010DG2D | 2.1 | 63.70 | 3 x 8 5/8 |
| 1700000 | 500C175U010FN2D | 1.8 | 73.40 | 3 1/2 x 7 5/8 |
| 2000000 | 500C205U010FG2D | 1.5 | 80.50 | 3 1/2 x 8 5/8 |
| 16 Vdc (20 Vdc Surge) | | | | |
| 15000 | 500C153U016AK2B | 46.9 | 4.7 | 1 3/8 x 1 5/8 |
| 27000 | 500C273U016AA2B | 26.5 | 6.9 | 1 3/8 x 2 1/8 |
| 36000 | 500C363U016AH2B | 20.1 | 8.6 | 1 3/8 x 2 5/8 |
| 48000 | 500C483U016AB2B | 15.5 | 10.5 | 1 3/8 x 3 1/8 |
| 49000 | 500C493U016EA2B | 18.8 | 9.6 | 1 3/4 x 2 1/8 |
| 61000 | 500C613U016AJ2B | 12.8 | 12.1 | 1 3/8 x 3 5/8 |
| 66000 | 500C663U016EH2B | 15.3 | 11.4 | 1 3/4 x 2 5/8 |
| 71000 | 500C713U016BA2B | 17.6 | 10.7 | 2 x 2 1/8 |
| 73000 | 500C733U016AC2B | 11.0 | 13.7 | 1 3/8 x 4 1/8 |

| Cap. (µF) | Catalog Part Number | ESR Max. @ 25 °C 120 Hz (mΩ) | Ripple Max. @ 85°C 120 Hz (A) | Nominal Size D x L (inches) |
|------------------------------|---------------------|------------------------------|-------------------------------|-----------------------------|
| 85000 | 500C853U016AD2B | 9.8 | 15.20 | 1 3/8 x 4 5/8 |
| 88000 | 500C883U016EB2B | 12.5 | 13.50 | 1 3/4 x 3 1/8 |
| 90000 | 500C903U016BH2B | 13.4 | 13.30 | 2 x 2 5/8 |
| 97000 | 500C973U016AE2B | 8.9 | 16.50 | 1 3/8 x 5 1/8 |
| 110000 | 500C114U016AF2B | 8.3 | 17.80 | 1 3/8 x 5 5/8 |
| 110000 | 500C114U016EJ2B | 10.9 | 15.20 | 1 3/4 x 3 5/8 |
| 110000 | 500C114U016BB2B | 10.5 | 16.00 | 2 x 3 1/8 |
| 130000 | 500C134U016EC2B | 9.7 | 16.90 | 1 3/4 x 4 1/8 |
| 140000 | 500C144U016BJ2B | 8.7 | 18.50 | 2 x 3 5/8 |
| 140000 | 500C144U016CH2B | 8.8 | 18.90 | 2 1/2 x 2 5/8 |
| 150000 | 500C154U016ED2B | 8.8 | 18.50 | 1 3/4 x 4 5/8 |
| 170000 | 500C174U016BC2B | 7.5 | 20.80 | 2 x 4 1/8 |
| 180000 | 500C184U016EE2B | 8.2 | 19.90 | 1 3/4 x 5 1/8 |
| 190000 | 500C194U016CB2B | 6.7 | 22.90 | 2 1/2 x 3 1/8 |
| 200000 | 500C204U016EF2B | 7.8 | 21.10 | 1 3/4 x 5 5/8 |
| 200000 | 500C204U016BD2B | 6.7 | 22.90 | 2 x 4 5/8 |
| 220000 | 500C224U016BE2B | 6.1 | 24.80 | 2 x 5 1/8 |
| 230000 | 500C234U016CJ2B | 5.5 | 26.50 | 2 1/2 x 3 5/8 |
| 250000 | 500C254U016BF2B | 5.7 | 26.50 | 2 x 5 5/8 |
| 280000 | 500C284U016CC2B | 5.0 | 29.20 | 2 1/2 x 4 1/8 |
| 280000 | 500C284U016DB2D | 4.2 | 32.40 | 3 x 3 1/8 |
| 320000 | 500C324U016CD2D | 4.6 | 31.40 | 2 1/2 x 4 5/8 |
| 350000 | 500C354U016DJ2D | 3.6 | 36.80 | 3 x 3 5/8 |
| 370000 | 500C374U016CE2D | 4.4 | 33.40 | 2 1/2 x 5 1/8 |
| 420000 | 500C424U016CF2D | 4.2 | 35.20 | 2 1/2 x 5 5/8 |
| 420000 | 500C424U016DC2D | 3.3 | 40.20 | 3 x 4 1/8 |
| 490000 | 500C494U016DD2D | 3.1 | 42.80 | 3 x 4 5/8 |
| 550000 | 500C554U016DE2D | 2.8 | 46.20 | 3 x 5 1/8 |
| 600000 | 500C604U016FC2D | 2.9 | 47.30 | 3 1/2 x 4 1/8 |
| 610000 | 500C614U016DF2D | 2.8 | 48.10 | 3 x 5 5/8 |
| 640000 | 500C644U016DP2D | 2.8 | 48.80 | 3 x 5 7/8 |
| 700000 | 500C704U016FD2D | 2.8 | 49.70 | 3 1/2 x 4 5/8 |
| 800000 | 500C804U016FE2D | 2.5 | 54.40 | 3 1/2 x 5 1/8 |
| 870000 | 500C874U016FF2D | 2.4 | 56.70 | 3 1/2 x 5 5/8 |
| 870000 | 500C874U016DN2D | 2.6 | 54.10 | 3 x 7 5/8 |
| 920000 | 500C924U016FP2D | 2.4 | 57.30 | 3 1/2 x 5 7/8 |
| 1000000 | 500C105U016DG2D | 2.6 | 57.10 | 3 x 8 5/8 |
| 1300000 | 500C135U016FN2D | 2.3 | 63.10 | 3 1/2 x 7 5/8 |
| 1500000 | 500C155U016FG2D | 2.3 | 66.40 | 3 1/2 x 8 5/8 |
| 25 Vdc (30 Vdc Surge) | | | | |
| 11000 | 500C113U025AK2B | 37.1 | 5.30 | 1 3/8 x 1 5/8 |
| 18000 | 500C183U025AA2B | 23.6 | 7.40 | 1 3/8 x 2 1/8 |
| 26000 | 500C263U025AH2B | 16.9 | 9.40 | 1 3/8 x 2 5/8 |
| 33000 | 500C333U025EA2B | 21.8 | 8.90 | 1 3/4 x 2 1/8 |
| 34000 | 500C343U025AB2B | 17.1 | 10.00 | 1 3/8 x 3 1/8 |
| 39000 | 500C393U025EH2B | 19.4 | 10.20 | 1 3/4 x 2 5/8 |
| 43000 | 500C433U025AJ2B | 17.7 | 10.30 | 1 3/8 x 3 5/8 |
| 47000 | 500C473U025BA2B | 21.8 | 9.70 | 2 x 2 1/8 |

Type 500C 95 °C Long-Life, Screw Terminal, Aluminum Electrolytic

| Cap. (µF) | Catalog Part Number | ESR Max. @ 25 °C 120 Hz (mΩ) | Ripple Max. @ 85 °C 120 Hz (A) | Nominal Size D x L (inches) |
|------------------------------|---------------------|------------------------------|--------------------------------|-----------------------------|
| 51000 | 500C513U025AC2B | 16.3 | 11.30 | 1 3/8 x 4 1/8 |
| 53000 | 500C533U025BH2B | 16.5 | 12.00 | 2 x 2 5/8 |
| 54000 | 500C543U025EB2B | 15.2 | 12.20 | 1 3/4 x 3 1/8 |
| 60000 | 500C603U025AD2B | 15.4 | 12.10 | 1 3/8 x 4 5/8 |
| 69000 | 500C693U025AE2B | 14.4 | 13.00 | 1 3/8 x 5 1/8 |
| 69000 | 500C693U025BB2B | 12.2 | 14.80 | 2 x 3 1/8 |
| 70000 | 500C703U025EJ2B | 12.8 | 14.10 | 1 3/4 x 3 5/8 |
| 77000 | 500C773U025AF2B | 13.4 | 14.00 | 1 3/8 x 5 5/8 |
| 82000 | 500C823U025CH2B | 9.5 | 18.10 | 2 1/2 x 2 5/8 |
| 86000 | 500C863U025EC2B | 11.2 | 15.70 | 1 3/4 x 4 1/8 |
| 89000 | 500C893U025BJ2B | 9.8 | 17.40 | 2 x 3 5/8 |
| 100000 | 500C104U025ED2B | 10.2 | 17.10 | 1 3/4 x 4 5/8 |
| 110000 | 500C114U025BC2B | 8.3 | 19.70 | 2 x 4 1/8 |
| 110000 | 500C114U025CB2B | 7.6 | 21.50 | 2 1/2 x 3 1/8 |
| 120000 | 500C124U025EE2B | 9.6 | 18.40 | 1 3/4 x 5 1/8 |
| 130000 | 500C134U025EF2B | 9.1 | 19.50 | 1 3/4 x 5 5/8 |
| 130000 | 500C134U025BD2B | 7.3 | 21.90 | 2 x 4 5/8 |
| 150000 | 500C154U025BE2B | 6.6 | 23.90 | 2 x 5 1/8 |
| 150000 | 500C154U025CJ2B | 6.4 | 24.60 | 2 1/2 x 3 5/8 |
| 170000 | 500C174U025BF2B | 6.1 | 25.70 | 2 x 5 5/8 |
| 170000 | 500C174U025DB2B | 5.0 | 29.70 | 3 x 3 1/8 |
| 180000 | 500C184U025CC2B | 5.8 | 27.00 | 2 1/2 x 4 1/8 |
| 210000 | 500C214U025CD2B | 5.2 | 29.50 | 2 1/2 x 4 5/8 |
| 220000 | 500C224U025DJ2D | 4.3 | 31.10 | 3 x 3 5/8 |
| 250000 | 500C254U025CE2D | 5.0 | 33.60 | 2 1/2 x 5 1/8 |
| 270000 | 500C274U025DC2D | 3.9 | 36.90 | 3 x 4 1/8 |
| 280000 | 500C284U025CF2D | 4.6 | 33.70 | 2 1/2 x 5 5/8 |
| 320000 | 500C324U025DD2D | 3.5 | 40.00 | 3 x 4 5/8 |
| 370000 | 500C374U025DE2D | 3.3 | 42.70 | 3 x 5 1/8 |
| 390000 | 500C394U025FC2D | 3.8 | 40.90 | 3 1/2 x 4 1/8 |
| 420000 | 500C424U025DF2D | 3.2 | 44.90 | 3 x 5 5/8 |
| 440000 | 500C444U025DP2D | 3.1 | 46.50 | 3 x 5 7/8 |
| 460000 | 500C464U025FD2D | 3.5 | 44.40 | 3 1/2 x 4 5/8 |
| 530000 | 500C534U025FE2D | 3.2 | 47.40 | 3 1/2 x 5 1/8 |
| 600000 | 500C604U025FF2D | 3.1 | 50.20 | 3 1/2 x 5 5/8 |
| 610000 | 500C614U025DN2D | 3.1 | 50.20 | 3 x 7 5/8 |
| 630000 | 500C634U025FP2D | 2.9 | 51.80 | 3 1/2 x 5 7/8 |
| 710000 | 500C714U025DG2D | 3.0 | 52.80 | 3 x 8 5/8 |
| 870000 | 500C874U025FN2D | 3.0 | 55.60 | 3 1/2 x 7 5/8 |
| 1000000 | 500C105U025FG2D | 2.9 | 58.30 | 3 1/2 x 8 5/8 |
| 35 Vdc (40 Vdc Surge) | | | | |
| 6600 | 500C662U035AK2B | 41.7 | 5.00 | 1 3/8 x 1 5/8 |
| 11000 | 500C113U035AA2B | 26.7 | 6.90 | 1 3/8 x 2 1/8 |
| 16000 | 500C163U035AH2B | 19.5 | 8.70 | 1 3/8 x 2 5/8 |
| 20000 | 500C203U035EA2B | 22.3 | 8.80 | 1 3/4 x 2 1/8 |
| 21000 | 500C213U035AB2B | 19.4 | 9.30 | 1 3/8 x 3 1/8 |
| 24000 | 500C243U035EH2B | 19.2 | 10.20 | 1 3/4 x 2 5/8 |
| 26000 | 500C263U035AJ2B | 19.7 | 9.80 | 1 3/8 x 3 5/8 |
| 26000 | 500C263U035BA2B | 24.5 | 9.10 | 2 x 2 1/8 |

| Cap. (µF) | Catalog Part Number | ESR Max. @ 25 °C 120 Hz (mΩ) | Ripple Max. @ 85 °C 120 Hz (A) | Nominal Size D x L (inches) |
|------------------------------|---------------------|------------------------------|--------------------------------|-----------------------------|
| 32000 | 500C323U035AC2B | 18.7 | 10.50 | 1 3/8 x 4 1/8 |
| 33000 | 500C333U035BH2B | 20.1 | 10.80 | 2 x 2 5/8 |
| 34000 | 500C343U035EB2B | 15.5 | 12.10 | 1 3/4 x 3 1/8 |
| 37000 | 500C373U035AD2B | 16.7 | 11.60 | 1 3/8 x 4 5/8 |
| 42000 | 500C423U035AE2B | 14.8 | 12.90 | 1 3/8 x 5 1/8 |
| 43000 | 500C433U035EJ2B | 13.2 | 13.80 | 1 3/4 x 3 5/8 |
| 43000 | 500C433U035BB2B | 15.9 | 13.00 | 2 x 3 1/8 |
| 48000 | 500C483U035AF2B | 13.5 | 14.00 | 1 3/8 x 5 5/8 |
| 51000 | 500C513U035CH2B | 14.8 | 14.50 | 2 1/2 x 2 5/8 |
| 53000 | 500C533U035EC2B | 11.8 | 15.30 | 1 3/4 x 4 1/8 |
| 55000 | 500C553U035BJ2B | 13.2 | 15.00 | 2 x 3 5/8 |
| 62000 | 500C623U035ED2B | 10.6 | 16.80 | 1 3/4 x 4 5/8 |
| 67000 | 500C673U035BC2B | 11.6 | 16.70 | 2 x 4 1/8 |
| 71000 | 500C713U035CB2B | 11.5 | 17.50 | 2 1/2 x 3 1/8 |
| 72000 | 500C723U035EE2B | 9.8 | 18.20 | 1 3/4 x 5 1/8 |
| 80000 | 500C803U035BD2B | 10.5 | 18.20 | 2 x 4 5/8 |
| 82000 | 500C823U035EF2B | 9.4 | 19.20 | 1 3/4 x 5 5/8 |
| 91000 | 500C913U035CJ2B | 9.4 | 20.30 | 2 1/2 x 3 5/8 |
| 92000 | 500C923U035BE2B | 9.8 | 19.50 | 2 x 5 1/8 |
| 100000 | 500C104U035BF2B | 9.4 | 20.70 | 2 x 5 5/8 |
| 110000 | 500C114U035CC2B | 8.2 | 22.60 | 2 1/2 x 4 1/8 |
| 110000 | 500C114U035DB2B | 6.9 | 25.30 | 3 x 3 1/8 |
| 130000 | 500C134U035CD2B | 7.4 | 24.80 | 2 1/2 x 4 5/8 |
| 140000 | 500C144U035DJ2B | 5.7 | 29.10 | 3 x 3 5/8 |
| 150000 | 500C154U035CE2B | 6.8 | 26.80 | 2 1/2 x 5 1/8 |
| 170000 | 500C174U035CF2B | 6.1 | 29.20 | 2 1/2 x 5 5/8 |
| 170000 | 500C174U035DC2D | 5.2 | 32.00 | 3 x 4 1/8 |
| 200000 | 500C204U035DD2D | 4.7 | 34.80 | 3 x 4 5/8 |
| 230000 | 500C234U035DE2D | 4.4 | 37.20 | 3 x 5 1/8 |
| 240000 | 500C244U035FC2D | 4.9 | 36.00 | 3 1/2 x 4 1/8 |
| 260000 | 500C264U035DF2D | 4.0 | 39.90 | 3 x 5 5/8 |
| 270000 | 500C274U035DP2D | 3.9 | 41.30 | 3 x 5 7/8 |
| 280000 | 500C284U035FD2D | 4.5 | 39.00 | 3 1/2 x 4 5/8 |
| 330000 | 500C334U035FE2D | 4.0 | 42.60 | 3 1/2 x 5 1/8 |
| 370000 | 500C374U035FF2D | 3.6 | 46.00 | 3 1/2 x 5 5/8 |
| 380000 | 500C384U035DN2D | 3.8 | 45.30 | 3 x 7 5/8 |
| 390000 | 500C394U035FP2D | 3.5 | 47.50 | 3 1/2 x 5 7/8 |
| 440000 | 500C444U035DG2D | 3.6 | 48.10 | 3 x 8 5/8 |
| 540000 | 500C544U035FN2D | 3.4 | 52.10 | 3 1/2 x 7 5/8 |
| 630000 | 500C634U035FG2D | 3.3 | 55.20 | 3 1/2 x 8 5/8 |
| 50 Vdc (65 Vdc Surge) | | | | |
| 4500 | 500C452U050AK2B | 47.9 | 4.70 | 1 3/8 x 1 5/8 |
| 7600 | 500C762U050AA2B | 30.9 | 6.40 | 1 3/8 x 2 1/8 |
| 11000 | 500C113U050AH2B | 21.8 | 8.30 | 1 3/8 x 2 5/8 |
| 14000 | 500C143U050AB2B | 20.9 | 9.00 | 1 3/8 x 3 1/8 |
| 14000 | 500C143U050EA2B | 22.8 | 8.70 | 1 3/4 x 2 1/8 |
| 16000 | 500C163U050EH2B | 20.2 | 10.00 | 1 3/4 x 2 5/8 |
| 17000 | 500C173U050BA2B | 25.3 | 9.00 | 2 x 2 1/8 |
| 18000 | 500C183U050AJ2B | 17.8 | 10.30 | 1 3/8 x 3 5/8 |

Type 500C 95 °C Long-Life, Screw Terminal, Aluminum Electrolytic

| Cap. (µF) | Catalog Part Number | ESR Max. @ 25 °C 120 Hz (mΩ) | Ripple Max. @ 85°C 120 Hz (A) | Nominal Size D x L (inches) |
|------------------------------|---------------------|------------------------------|-------------------------------|-----------------------------|
| 21000 | 500C213U050AC2B | 17.3 | 11.00 | 1 3/8 x 4 1/8 |
| 22000 | 500C223U050BH2B | 20.8 | 10.70 | 2 x 2 5/8 |
| 23000 | 500C233U050EB2B | 15.6 | 12.10 | 1 3/4 x 3 1/8 |
| 25000 | 500C253U050AD2B | 16.8 | 11.60 | 1 3/8 x 4 5/8 |
| 29000 | 500C293U050AE2B | 15.1 | 12.70 | 1 3/8 x 5 1/8 |
| 29000 | 500C293U050EJ2B | 13.5 | 13.60 | 1 3/4 x 3 5/8 |
| 29000 | 500C293U050BB2B | 16.3 | 12.80 | 2 x 3 1/8 |
| 32000 | 500C323U050AF2B | 13.8 | 13.80 | 1 3/8 x 5 5/8 |
| 34000 | 500C343U050CH2B | 15.1 | 14.40 | 2 1/2 x 2 5/8 |
| 36000 | 500C363U050EC2B | 12.0 | 15.20 | 1 3/4 x 4 1/8 |
| 37000 | 500C373U050BJ2B | 13.6 | 14.80 | 2 x 3 5/8 |
| 42000 | 500C423U050ED2B | 10.8 | 16.60 | 1 3/4 x 4 5/8 |
| 46000 | 500C463U050BC2B | 11.9 | 16.50 | 2 x 4 1/8 |
| 48000 | 500C483U050CB2B | 12.0 | 17.10 | 2 1/2 x 3 1/8 |
| 49000 | 500C493U050EE2B | 9.8 | 18.10 | 1 3/4 x 5 1/8 |
| 54000 | 500C543U050BD2B | 10.8 | 18.00 | 2 x 4 5/8 |
| 55000 | 500C553U050EF2B | 9.5 | 19.10 | 1 3/4 x 5 5/8 |
| 62000 | 500C623U050BE2B | 10.0 | 19.40 | 2 x 5 1/8 |
| 62000 | 500C623U050CJ2B | 10.3 | 19.40 | 2 1/2 x 3 5/8 |
| 70000 | 500C703U050BF2B | 9.5 | 20.50 | 2 x 5 5/8 |
| 72000 | 500C723U050DB2B | 9.1 | 22.00 | 3 x 3 1/8 |
| 75000 | 500C753U050CC2B | 8.9 | 21.80 | 2 1/2 x 4 1/8 |
| 89000 | 500C893U050CD2B | 7.9 | 24.00 | 2 1/2 x 4 5/8 |
| 92000 | 500C923U050DJ2B | 7.7 | 25.10 | 3 x 3 5/8 |
| 100000 | 500C104U050CE2B | 7.2 | 26.00 | 2 1/2 x 5 1/8 |
| 110000 | 500C114U050DC2B | 6.9 | 27.60 | 3 x 4 1/8 |
| 120000 | 500C124U050CF2B | 6.7 | 27.90 | 2 1/2 x 5 5/8 |
| 130000 | 500C134U050DD2D | 6.1 | 30.40 | 3 x 4 5/8 |
| 150000 | 500C154U050DE2D | 5.9 | 32.00 | 3 x 5 1/8 |
| 150000 | 500C154U050FC2D | 6.4 | 31.70 | 3 1/2 x 4 1/8 |
| 170000 | 500C174U050DF2D | 5.6 | 33.80 | 3 x 5 5/8 |
| 180000 | 500C184U050DP2D | 5.4 | 35.00 | 3 x 5 7/8 |
| 180000 | 500C184U050FD2D | 5.7 | 34.70 | 3 1/2 x 4 5/8 |
| 200000 | 500C204U050FE2D | 5.4 | 36.80 | 3 1/2 x 5 1/8 |
| 230000 | 500C234U050FF2D | 5.0 | 39.00 | 3 1/2 x 5 5/8 |
| 250000 | 500C254U050FP2D | 5.0 | 40.00 | 3 1/2 x 5 7/8 |
| 260000 | 500C264U050DN2D | 5.0 | 42.00 | 3 x 7 5/8 |
| 300000 | 500C304U050DG2D | 4.0 | 45.00 | 3 x 8 5/8 |
| 340000 | 500C344U050FN2D | 4.0 | 47.00 | 3 1/2 x 7 5/8 |
| 400000 | 500C404U050FG2D | 4.0 | 51.00 | 3 1/2 x 8 5/8 |
| 63 Vdc (75 Vdc Surge) | | | | |
| 3400 | 500C342U063AK2B | 60.6 | 4.10 | 1 3/8 x 1 5/8 |
| 5800 | 500C582U063AA2B | 39.0 | 5.70 | 1 3/8 x 2 1/8 |
| 8200 | 500C822U063AH2B | 27.4 | 7.40 | 1 3/8 x 2 5/8 |
| 11000 | 500C113U063AB2B | 25.2 | 8.20 | 1 3/8 x 3 1/8 |
| 11000 | 500C113U063EA2B | 27.9 | 7.90 | 1 3/4 x 2 1/8 |
| 12000 | 500C123U063EH2B | 25.6 | 8.80 | 1 3/4 x 2 5/8 |
| 13000 | 500C133U063BA2B | 28.0 | 8.50 | 2 x 2 1/8 |
| 14000 | 500C143U063AJ2B | 23.7 | 8.90 | 1 3/8 x 3 5/8 |

| Cap. (µF) | Catalog Part Number | ESR Max. @ 25 °C 120 Hz (mΩ) | Ripple Max. @ 85°C 120 Hz (A) | Nominal Size D x L (inches) |
|------------------------------|---------------------|------------------------------|-------------------------------|-----------------------------|
| 15000 | 500C153U063BH2B | 22.6 | 10.20 | 2 x 2 5/8 |
| 16000 | 500C163U063AC2B | 20.4 | 10.10 | 1 3/8 x 4 1/8 |
| 17000 | 500C173U063EB2B | 19.5 | 10.80 | 1 3/4 x 3 1/8 |
| 19000 | 500C193U063AD2B | 18.1 | 11.20 | 1 3/8 x 4 5/8 |
| 20000 | 500C203U063BB2B | 18.1 | 12.10 | 2 x 3 1/8 |
| 22000 | 500C223U063AE2B | 16.4 | 12.20 | 1 3/8 x 5 1/8 |
| 22000 | 500C223U063EJ2B | 16.2 | 12.50 | 1 3/4 x 3 5/8 |
| 24000 | 500C243U063CH2B | 26.8 | 10.80 | 2 1/2 x 2 5/8 |
| 25000 | 500C253U063AF2B | 15.1 | 13.20 | 1 3/8 x 5 5/8 |
| 26000 | 500C263U063BJ2B | 15.1 | 14.00 | 2 x 3 5/8 |
| 27000 | 500C273U063EC2B | 14.2 | 14.00 | 1 3/4 x 4 1/8 |
| 32000 | 500C323U063ED2B | 12.8 | 15.30 | 1 3/4 x 4 5/8 |
| 32000 | 500C323U063BC2B | 13.3 | 15.60 | 2 x 4 1/8 |
| 34000 | 500C343U063CB2B | 19.3 | 13.50 | 2 1/2 x 3 1/8 |
| 37000 | 500C373U063EE2B | 11.8 | 16.50 | 1 3/4 x 5 1/8 |
| 38000 | 500C383U063BD2B | 12.1 | 17.00 | 2 x 4 5/8 |
| 42000 | 500C423U063EF2B | 11.2 | 17.60 | 1 3/4 x 5 5/8 |
| 43000 | 500C433U063CJ2B | 17.1 | 15.10 | 2 1/2 x 3 5/8 |
| 44000 | 500C443U063BE2B | 11.3 | 18.30 | 2 x 5 1/8 |
| 49000 | 500C493U063BF2B | 10.7 | 19.40 | 2 x 5 5/8 |
| 50000 | 500C503U063DB2B | 14.9 | 17.20 | 3 x 3 1/8 |
| 53000 | 500C533U063CC2B | 13.7 | 17.50 | 2 1/2 x 4 1/8 |
| 62000 | 500C623U063CD2B | 11.8 | 19.60 | 2 1/2 x 4 5/8 |
| 65000 | 500C653U063DJ2B | 12.1 | 20.00 | 3 x 3 5/8 |
| 72000 | 500C723U063CE2B | 11.0 | 21.10 | 2 1/2 x 5 1/8 |
| 79000 | 500C793U063DC2B | 10.8 | 22.10 | 3 x 4 1/8 |
| 82000 | 500C823U063CF2B | 10.5 | 22.30 | 2 1/2 x 5 5/8 |
| 93000 | 500C933U063DD2B | 9.9 | 23.90 | 3 x 4 5/8 |
| 110000 | 500C114U063DE2B | 8.8 | 26.30 | 3 x 5 1/8 |
| 110000 | 500C114U063FC2D | 9.9 | 25.40 | 3 1/2 x 4 1/8 |
| 120000 | 500C124U063DF2B | 7.9 | 28.50 | 3 x 5 5/8 |
| 130000 | 500C134U063DP2B | 7.5 | 29.60 | 3 x 5 7/8 |
| 130000 | 500C134U063FD2D | 9.0 | 27.60 | 3 1/2 x 4 5/8 |
| 150000 | 500C154U063FE2D | 7.9 | 30.30 | 3 1/2 x 5 1/8 |
| 170000 | 500C174U063FF2D | 7.2 | 32.80 | 3 1/2 x 5 5/8 |
| 180000 | 500C184U063DN2D | 6.5 | 35.00 | 3 x 7 5/8 |
| 180000 | 500C184U063FP2D | 6.8 | 34.00 | 3 1/2 x 5 7/8 |
| 210000 | 500C214U063DG2D | 5.7 | 38.30 | 3 x 8 5/8 |
| 250000 | 500C254U063FN2D | 5.8 | 40.20 | 3 1/2 x 7 5/8 |
| 290000 | 500C294U063FG2D | 5.2 | 43.90 | 3 1/2 x 8 5/8 |
| 75 Vdc (95 Vdc Surge) | | | | |
| 2700 | 500C272U075AK2B | 76.2 | 3.70 | 1 3/8 x 1 5/8 |
| 4300 | 500C432U075AA2B | 50.7 | 5.00 | 1 3/8 x 2 1/8 |
| 6400 | 500C642U075AH2B | 35.0 | 6.50 | 1 3/8 x 2 5/8 |
| 8300 | 500C832U075EA2B | 55.6 | 5.60 | 1 3/4 x 2 1/8 |
| 8600 | 500C862U075AB2B | 34.0 | 7.10 | 1 3/8 x 3 1/8 |
| 9800 | 500C982U075EH2B | 47.3 | 6.50 | 1 3/4 x 2 5/8 |
| 10000 | 500C103U075BA2B | 34.8 | 7.70 | 2 x 2 1/8 |
| 11000 | 500C113U075AJ2B | 31.1 | 7.80 | 1 3/8 x 3 5/8 |

Type 500C 95 °C Long-Life, Screw Terminal, Aluminum Electrolytic

| Cap. (μ F) | Catalog Part Number | ESR Max. @ 25 °C 120 Hz (m Ω) | Ripple Max. @ 85°C 120 Hz (A) | Nominal Size D x L (inches) | Cap. (μ F) | Catalog Part Number | ESR Max. @ 25 °C 120 Hz (m Ω) | Ripple Max. @ 85°C 120 Hz (A) | Nominal Size D x L (inches) |
|--------------------------------|---------------------|--|--|-----------------------------------|--------------------------|---------------------|--|--|-----------------------------------|
| 11000 | 500C113U075BH2B | 27.5 | 9.30 | 2 x 2 5/8 | 7300 | 500C732U100BH2B | 37.8 | 7.90 | 2 x 2 5/8 |
| 13000 | 500C133U075AC2B | 28.2 | 8.60 | 1 3/8 x 4 1/8 | 7600 | 500C762U100AC2B | 30.7 | 8.20 | 1 3/8 x 4 1/8 |
| 14000 | 500C143U075EB2B | 34.1 | 8.20 | 1 3/4 x 3 1/8 | 8100 | 500C812U100EB2B | 38.0 | 7.70 | 1 3/4 x 3 1/8 |
| 15000 | 500C153U075AD2B | 24.5 | 9.60 | 1 3/8 x 4 5/8 | 8900 | 500C892U100AD2B | 29.0 | 8.80 | 1 3/8 x 4 5/8 |
| 16000 | 500C163U075BB2B | 21.4 | 11.20 | 2 x 3 1/8 | 10000 | 500C103U100AE2B | 28.3 | 9.30 | 1 3/8 x 5 1/8 |
| 17000 | 500C173U075AE2B | 22.5 | 10.40 | 1 3/8 x 5 1/8 | 10000 | 500C103U100EJ2B | 29.9 | 9.20 | 1 3/4 x 3 5/8 |
| 18000 | 500C183U075EJ2B | 26.9 | 9.70 | 1 3/4 x 3 5/8 | 10000 | 500C103U100BB2B | 30.6 | 9.30 | 2 x 3 1/8 |
| 19000 | 500C193U075AF2B | 20.4 | 11.30 | 1 3/8 x 5 5/8 | 11000 | 500C113U100AF2B | 27.6 | 9.70 | 1 3/8 x 5 5/8 |
| 19000 | 500C193U075CH2B | 30.0 | 10.20 | 2 1/2 x 2 5/8 | 12000 | 500C123U100CH2B | 33.7 | 9.60 | 2 1/2 x 2 5/8 |
| 21000 | 500C213U075EC2B | 22.3 | 11.10 | 1 3/4 x 4 1/8 | 13000 | 500C133U100EC2B | 24.8 | 10.60 | 1 3/4 x 4 1/8 |
| 21000 | 500C213U075BJ2B | 18.0 | 12.80 | 2 x 3 5/8 | 13000 | 500C133U100BJ2B | 22.3 | 11.50 | 2 x 3 5/8 |
| 25000 | 500C253U075ED2B | 19.2 | 12.50 | 1 3/4 x 4 5/8 | 15000 | 500C153U100ED2B | 21.2 | 11.90 | 1 3/4 x 4 5/8 |
| 25000 | 500C253U075BC2B | 15.6 | 14.40 | 2 x 4 1/8 | 16000 | 500C163U100BC2B | 19.9 | 12.80 | 2 x 4 1/8 |
| 26000 | 500C263U075CB2B | 21.6 | 12.70 | 2 1/2 x 3 1/8 | 17000 | 500C173U100EE2B | 18.7 | 13.10 | 1 3/4 x 5 1/8 |
| 29000 | 500C293U075EE2B | 16.9 | 13.80 | 1 3/4 x 5 1/8 | 17000 | 500C173U100CB2B | 23.4 | 12.30 | 2 1/2 x 3 1/8 |
| 30000 | 500C303U075BD2B | 13.9 | 15.80 | 2 x 4 5/8 | 19000 | 500C193U100BD2B | 17.7 | 14.10 | 2 x 4 5/8 |
| 33000 | 500C333U075EF2B | 15.2 | 15.10 | 1 3/4 x 5 5/8 | 20000 | 500C203U100EF2B | 16.8 | 14.30 | 1 3/4 x 5 5/8 |
| 34000 | 500C343U075BE2B | 12.8 | 17.10 | 2 x 5 1/8 | 22000 | 500C223U100BE2B | 15.6 | 15.50 | 2 x 5 1/8 |
| 34000 | 500C343U075CJ2B | 17.8 | 14.80 | 2 1/2 x 3 5/8 | 22000 | 500C223U100CJ2B | 19.1 | 14.30 | 2 1/2 x 3 5/8 |
| 39000 | 500C393U075BF2B | 12.0 | 18.30 | 2 x 5 5/8 | 25000 | 500C253U100BF2B | 14.9 | 16.40 | 2 x 5 5/8 |
| 40000 | 500C403U075DB2B | 18.0 | 15.60 | 3 x 3 1/8 | 25000 | 500C253U100DB2B | 19.9 | 14.90 | 3 x 3 1/8 |
| 42000 | 500C423U075CC2B | 15.1 | 16.70 | 2 1/2 x 4 1/8 | 27000 | 500C273U100CC2B | 16.5 | 16.00 | 2 1/2 x 4 1/8 |
| 49000 | 500C493U075CD2B | 13.5 | 18.40 | 2 1/2 x 4 5/8 | 32000 | 500C323U100CD2B | 14.7 | 17.60 | 2 1/2 x 4 5/8 |
| 51000 | 500C513U075DJ2B | 14.4 | 18.30 | 3 x 3 5/8 | 33000 | 500C333U100DJ2B | 16.4 | 17.20 | 3 x 3 5/8 |
| 57000 | 500C573U075CE2B | 12.0 | 20.20 | 2 1/2 x 5 1/8 | 36000 | 500C363U100CE2B | 13.4 | 19.10 | 2 1/2 x 5 1/8 |
| 62000 | 500C623U075DC2B | 12.9 | 20.20 | 3 x 4 1/8 | 40000 | 500C403U100DC2B | 14.4 | 19.10 | 3 x 4 1/8 |
| 64000 | 500C643U075CF2B | 11.2 | 21.50 | 2 1/2 x 5 5/8 | 41000 | 500C413U100CF2B | 12.5 | 20.40 | 2 1/2 x 5 5/8 |
| 74000 | 500C743U075DD2B | 11.8 | 21.90 | 3 x 4 5/8 | 47000 | 500C473U100DD2B | 13.0 | 20.90 | 3 x 4 5/8 |
| 85000 | 500C853U075DE2B | 10.4 | 24.10 | 3 x 5 1/8 | 54000 | 500C543U100DE2B | 12.0 | 22.50 | 3 x 5 1/8 |
| 85000 | 500C853U075FC2D | 11.8 | 23.20 | 3 1/2 x 4 1/8 | 55000 | 500C553U100FC2D | 13.4 | 21.80 | 3 1/2 x 4 1/8 |
| 96000 | 500C963U075DF2B | 9.4 | 26.20 | 3 x 5 5/8 | 62000 | 500C623U100DF2B | 11.2 | 23.90 | 3 x 5 5/8 |
| 100000 | 500C104U075DP2B | 8.9 | 27.20 | 3 x 5 7/8 | 65000 | 500C653U100DP2B | 11.1 | 24.40 | 3 x 5 7/8 |
| 100000 | 500C104U075FD2D | 10.7 | 25.30 | 3 1/2 x 4 5/8 | 65000 | 500C653U100FD2D | 12.1 | 23.80 | 3 1/2 x 4 5/8 |
| 120000 | 500C124U075FE2D | 9.4 | 27.80 | 3 1/2 x 5 1/8 | 74000 | 500C743U100FE2D | 10.9 | 25.90 | 3 1/2 x 5 1/8 |
| 130000 | 500C134U075FF2D | 8.4 | 30.20 | 3 1/2 x 5 5/8 | 84000 | 500C843U100FF2D | 10.2 | 27.50 | 3 1/2 x 5 5/8 |
| 140000 | 500C144U075DN2D | 7.7 | 32.10 | 3 x 7 5/8 | 89000 | 500C893U100FP2D | 10.0 | 28.10 | 3 1/2 x 5 7/8 |
| 140000 | 500C144U075FP2D | 8.1 | 31.30 | 3 1/2 x 5 7/8 | 94000 | 500C943U100DN2D | 9.2 | 29.40 | 3 x 7 5/8 |
| 160000 | 500C164U075DG2D | 6.8 | 35.10 | 3 x 8 5/8 | 110000 | 500C114U100DG2D | 8.2 | 32.10 | 3 x 8 5/8 |
| 190000 | 500C194U075FN2D | 6.9 | 36.80 | 3 1/2 x 7 5/8 | 120000 | 500C124U100FN2D | 8.3 | 33.70 | 3 1/2 x 7 5/8 |
| 220000 | 500C224U075FG2D | 6.2 | 40.20 | 3 1/2 x 8 5/8 | 140000 | 500C144U100FG2D | 7.3 | 36.80 | 3 1/2 x 8 5/8 |
| 100 Vdc (125 Vdc Surge) | | | | | 160 Vdc (200 Vdc) | | | | |
| 1600 | 500C162U100AK2B | 98.4 | 3.30 | 1 3/8 x 1 5/8 | 750 | 500C751T160AK2B | 150.0 | 2.60 | 1 3/8 x 1 5/8 |
| 2500 | 500C252U100AA2B | 60.2 | 4.60 | 1 3/8 x 2 1/8 | 1200 | 500C122T160AA2B | 93.0 | 3.70 | 1 3/8 x 2 1/8 |
| 3800 | 500C382U100AH2B | 42.7 | 5.90 | 1 3/8 x 2 5/8 | 1500 | 500C152T160AH2B | 70.5 | 4.60 | 1 3/8 x 2 5/8 |
| 4900 | 500C492U100EA2B | 62.0 | 5.30 | 1 3/4 x 2 1/8 | 2100 | 500C212T160AB2B | 58.5 | 5.40 | 1 3/8 x 3 1/8 |
| 5100 | 500C512U100AB2B | 38.2 | 6.70 | 1 3/8 x 3 1/8 | 2300 | 500C232T160EA2B | 62.0 | 5.30 | 1 3/4 x 2 1/8 |
| 5100 | 500C512U100BA2B | 51.8 | 6.30 | 2 x 2 1/8 | 2400 | 500C242T160BA2B | 70.5 | 5.40 | 2 x 2 1/8 |
| 5800 | 500C582U100EH2B | 52.8 | 6.20 | 1 3/4 x 2 5/8 | 2700 | 500C272T160AJ2B | 50.2 | 6.10 | 1 3/8 x 3 5/8 |
| 6300 | 500C632U100AJ2B | 33.0 | 7.60 | 1 3/8 x 3 5/8 | 2700 | 500C272T160EH2B | 52.8 | 6.20 | 1 3/4 x 2 5/8 |

Type 500C 95 °C Long-Life, Screw Terminal, Aluminum Electrolytic

| Cap. (µF) | Catalog Part Number | ESR Max. @ 25 °C 120 Hz (mΩ) | Ripple Max. @ 85°C 120 Hz (A) | Nominal Size D x L (inches) |
|--------------------------------|---------------------|------------------------------|-------------------------------|-----------------------------|
| 3300 | 500C332T160AC2B | 42.9 | 7.00 | 1 3/8 x 4 1/8 |
| 3500 | 500C352T160BH2B | 46.5 | 7.10 | 2 x 2 5/8 |
| 3800 | 500C382T160EB2B | 38.0 | 7.70 | 1 3/4 x 3 1/8 |
| 3900 | 500C392T160AD2B | 37.7 | 7.70 | 1 3/8 x 4 5/8 |
| 4500 | 500C452T160AE2B | 34.7 | 8.40 | 1 3/8 x 5 1/8 |
| 4900 | 500C492T160EJ2B | 29.9 | 9.20 | 1 3/4 x 3 5/8 |
| 4900 | 500C492T160BB2B | 33.5 | 8.90 | 2 x 3 1/8 |
| 5100 | 500C512T160AF2B | 32.2 | 9.00 | 1 3/8 x 5 5/8 |
| 5500 | 500C552T160CH2B | 30.1 | 10.20 | 2 1/2 x 2 5/8 |
| 6000 | 500C602T160EC2B | 24.8 | 10.60 | 1 3/4 x 4 1/8 |
| 6300 | 500C632T160BJ2B | 26.4 | 10.60 | 2 x 3 5/8 |
| 7100 | 500C712T160ED2B | 21.2 | 11.90 | 1 3/4 x 4 5/8 |
| 7700 | 500C772T160BC2B | 21.9 | 12.20 | 2 x 4 1/8 |
| 7700 | 500C772T160CB2B | 21.3 | 12.80 | 2 1/2 x 3 1/8 |
| 8200 | 500C822T160EE2B | 18.7 | 13.10 | 1 3/4 x 5 1/8 |
| 9100 | 500C912T160BD2B | 18.8 | 13.60 | 2 x 4 5/8 |
| 9300 | 500C932T160EF2B | 16.8 | 14.30 | 1 3/4 x 5 5/8 |
| 9900 | 500C992T160CJ2B | 17.0 | 15.10 | 2 1/2 x 3 5/8 |
| 10000 | 500C103T160BE2B | 16.6 | 15.00 | 2 x 5 1/8 |
| 11000 | 500C113T160DB2B | 14.7 | 17.30 | 3 x 3 1/8 |
| 12000 | 500C123T160BF2B | 14.9 | 16.40 | 2 x 5 5/8 |
| 12000 | 500C123T160CC2B | 14.1 | 17.30 | 2 1/2 x 4 1/8 |
| 14000 | 500C143T160CD2B | 11.9 | 19.60 | 2 1/2 x 4 5/8 |
| 15000 | 500C153T160DJ2B | 11.5 | 20.50 | 3 x 3 5/8 |
| 16000 | 500C163T160CE2B | 10.7 | 21.30 | 2 1/2 x 5 1/8 |
| 18000 | 500C183T160DC2B | 9.6 | 23.40 | 3 x 4 1/8 |
| 19000 | 500C193T160CF2B | 9.6 | 23.20 | 2 1/2 x 5 5/8 |
| 21000 | 500C213T160DD2B | 8.2 | 26.20 | 3 x 4 5/8 |
| 25000 | 500C253T160DE2B | 7.3 | 28.90 | 3 x 5 1/8 |
| 25000 | 500C253T160FC2D | 9.2 | 26.40 | 3 1/2 x 4 1/8 |
| 28000 | 500C283T160DF2D | 6.5 | 31.40 | 3 x 5 5/8 |
| 29000 | 500C293T160DP2D | 6.2 | 32.60 | 3 x 5 7/8 |
| 29000 | 500C293T160FD2D | 7.9 | 29.50 | 3 1/2 x 4 5/8 |
| 34000 | 500C343T160FE2D | 6.9 | 32.40 | 3 1/2 x 5 1/8 |
| 38000 | 500C383T160FF2D | 6.2 | 35.10 | 3 1/2 x 5 5/8 |
| 40000 | 500C403T160FP2D | 5.9 | 36.50 | 3 1/2 x 5 7/8 |
| 41000 | 500C413T160DN2D | 5.1 | 39.80 | 3 x 7 5/8 |
| 47000 | 500C473T160DG2D | 4.3 | 44.00 | 3 x 8 5/8 |
| 56000 | 500C563T160FN2D | 4.9 | 44.30 | 3 1/2 x 7 5/8 |
| 65000 | 500C653T160FG2D | 4.2 | 48.80 | 3 1/2 x 8 5/8 |
| 200 Vdc (250 Vdc Surge) | | | | |
| 540 | 500C541T200AK2B | 206.0 | 2.30 | 1 3/8 x 1 5/8 |
| 770 | 500C771T200AA2B | 140.0 | 3.00 | 1 3/8 x 2 1/8 |
| 970 | 500C971T200AH2B | 101.0 | 3.90 | 1 3/8 x 2 5/8 |
| 1400 | 500C142T200AB2B | 78.5 | 4.60 | 1 3/8 x 3 1/8 |
| 1500 | 500C152T200EA2B | 79.1 | 4.70 | 1 3/4 x 2 1/8 |
| 1600 | 500C162T200BA2B | 82.0 | 5.00 | 2 x 2 1/8 |
| 1700 | 500C172T200AJ2B | 63.9 | 5.40 | 1 3/8 x 3 5/8 |
| 1700 | 500C172T200EH2B | 62.5 | 5.70 | 1 3/4 x 2 5/8 |

| Cap. (µF) | Catalog Part Number | ESR Max. @ 25 °C 120 Hz (mΩ) | Ripple Max. @ 85°C 120 Hz (A) | Nominal Size D x L (inches) |
|--------------------------------|---------------------|------------------------------|-------------------------------|-----------------------------|
| 2100 | 500C212T200AC2B | 51.7 | 6.30 | 1 3/8 x 4 1/8 |
| 2200 | 500C222T200BH2B | 61.0 | 6.20 | 2 x 2 5/8 |
| 2400 | 500C242T200EB2B | 48.4 | 6.90 | 1 3/4 x 3 1/8 |
| 2500 | 500C252T200AD2B | 43.2 | 7.20 | 1 3/8 x 4 5/8 |
| 2900 | 500C292T200AE2B | 37.8 | 8.00 | 1 3/8 x 5 1/8 |
| 3100 | 500C312T200EJ2B | 37.9 | 8.20 | 1 3/4 x 3 5/8 |
| 3100 | 500C312T200BB2B | 46.1 | 7.60 | 2 x 3 1/8 |
| 3300 | 500C332T200AF2B | 33.4 | 8.90 | 1 3/8 x 5 5/8 |
| 3500 | 500C352T200CH2B | 42.2 | 8.60 | 2 1/2 x 2 5/8 |
| 3800 | 500C382T200EC2B | 31.3 | 9.40 | 1 3/4 x 4 1/8 |
| 4000 | 500C402T200BJ2B | 36.2 | 9.00 | 2 x 3 5/8 |
| 4500 | 500C452T200ED2B | 26.8 | 10.60 | 1 3/4 x 4 5/8 |
| 4900 | 500C492T200BC2B | 28.5 | 10.60 | 2 x 4 1/8 |
| 4900 | 500C492T200CB2B | 31.2 | 10.60 | 2 1/2 x 3 1/8 |
| 5200 | 500C522T200EE2B | 23.5 | 11.70 | 1 3/4 x 5 1/8 |
| 5800 | 500C582T200BD2B | 24.4 | 12.00 | 2 x 4 5/8 |
| 5900 | 500C592T200EF2B | 21.0 | 12.80 | 1 3/4 x 5 5/8 |
| 6200 | 500C622T200CJ2B | 22.3 | 13.20 | 2 1/2 x 3 5/8 |
| 6700 | 500C672T200BE2B | 21.7 | 13.20 | 2 x 5 1/8 |
| 7600 | 500C762T200BF2B | 19.6 | 14.30 | 2 x 5 5/8 |
| 7600 | 500C762T200CC2B | 20.3 | 14.40 | 2 1/2 x 4 1/8 |
| 7600 | 500C762T200DB2B | 30.3 | 12.10 | 3 x 3 1/8 |
| 9000 | 500C902T200CD2B | 17.3 | 16.20 | 2 1/2 x 4 5/8 |
| 9800 | 500C982T200DJ2B | 23.7 | 14.30 | 3 x 3 5/8 |
| 10000 | 500C103T200CE2B | 15.8 | 17.60 | 2 1/2 x 5 1/8 |
| 12000 | 500C123T200CF2B | 13.7 | 19.40 | 2 1/2 x 5 5/8 |
| 12000 | 500C123T200DC2B | 19.7 | 16.30 | 3 x 4 1/8 |
| 14000 | 500C143T200DD2B | 16.9 | 18.30 | 3 x 4 5/8 |
| 15000 | 500C153T200FC2B | 17.1 | 19.30 | 3 1/2 x 4 1/8 |
| 16000 | 500C163T200FG2B | 14.8 | 20.20 | 3 x 5 1/8 |
| 18000 | 500C183T200DF2B | 13.3 | 22.00 | 3 x 5 5/8 |
| 19000 | 500C193T200DP2B | 15.3 | 20.70 | 3 x 5 7/8 |
| 20000 | 500C203T200FD2B | 12.7 | 23.30 | 3 1/2 x 4 5/8 |
| 21000 | 500C213T200FE2D | 13.4 | 23.30 | 3 1/2 x 5 1/8 |
| 24000 | 500C243T200FF2D | 12.0 | 25.30 | 3 1/2 x 5 5/8 |
| 25000 | 500C253T200FP2D | 11.5 | 26.30 | 3 1/2 x 5 7/8 |
| 26000 | 500C263T200DN2B | 11.7 | 26.40 | 3 x 7 5/8 |
| 31000 | 500C313T200DG2B | 9.6 | 29.60 | 3 x 8 5/8 |
| 35000 | 500C353T200FN2D | 9.3 | 32.10 | 3 1/2 x 7 5/8 |
| 40000 | 500C403T200FG2D | 7.9 | 35.50 | 3 1/2 x 8 5/8 |
| 250 Vdc (300 Vdc Surge) | | | | |
| 380 | 500C381T250AK2B | 260.0 | 2.00 | 1 3/8 x 1 5/8 |
| 680 | 500C681T250AA2B | 156.0 | 2.90 | 1 3/8 x 2 1/8 |
| 830 | 500C831T250AH2B | 119.0 | 3.50 | 1 3/8 x 2 5/8 |
| 1100 | 500C112T250AB2B | 87.5 | 4.40 | 1 3/8 x 3 1/8 |
| 1100 | 500C112T250EA2B | 99.1 | 4.20 | 1 3/4 x 2 1/8 |
| 1200 | 500C122T250BA2B | 94.6 | 4.60 | 2 x 2 1/8 |
| 1300 | 500C132T250EH2B | 82.8 | 4.90 | 1 3/4 x 2 5/8 |
| 1400 | 500C142T250AJ2B | 69.5 | 5.20 | 1 3/8 x 3 5/8 |

Type 500C 95 °C Long-Life, Screw Terminal, Aluminum Electrolytic

| Cap. (µF) | Catalog Part Number | ESR Max. @ 25 °C 120 Hz (mΩ) | Ripple Max. @ 85°C 120 Hz (A) | Nominal Size D x L (inches) |
|--------------------------------|---------------------|------------------------------|-------------------------------|-----------------------------|
| 1700 | 500C172T250AC2B | 57.8 | 6.00 | 1 3/8 x 4 1/8 |
| 1700 | 500C172T250BH2B | 65.7 | 6.00 | 2 x 2 5/8 |
| 1800 | 500C182T250EB2B | 61.1 | 6.10 | 1 3/4 x 3 1/8 |
| 2000 | 500C202T250AD2B | 51.5 | 6.60 | 1 3/8 x 4 5/8 |
| 2300 | 500C232T250AE2B | 44.1 | 7.40 | 1 3/8 x 5 1/8 |
| 2300 | 500C232T250EJ2B | 48.5 | 7.20 | 1 3/4 x 3 5/8 |
| 2400 | 500C242T250BB2B | 46.2 | 7.60 | 2 x 3 1/8 |
| 2600 | 500C262T250AF2B | 38.4 | 8.30 | 1 3/8 x 5 5/8 |
| 2600 | 500C262T250CH2B | 51.6 | 7.80 | 2 1/2 x 2 5/8 |
| 2800 | 500C282T250EC2B | 40.4 | 8.30 | 1 3/4 x 4 1/8 |
| 3100 | 500C312T250BJ2B | 38.1 | 8.80 | 2 x 3 5/8 |
| 3300 | 500C332T250ED2B | 34.7 | 9.30 | 1 3/4 x 4 5/8 |
| 3700 | 500C372T250CB2B | 32.0 | 10.50 | 2 1/2 x 3 1/8 |
| 3800 | 500C382T250EE2B | 30.5 | 10.30 | 1 3/4 x 5 1/8 |
| 3800 | 500C382T250BC2B | 31.4 | 10.10 | 2 x 4 1/8 |
| 4300 | 500C432T250EF2B | 27.3 | 11.20 | 1 3/4 x 5 5/8 |
| 4500 | 500C452T250BD2B | 26.9 | 11.40 | 2 x 4 5/8 |
| 4700 | 500C472T250CJ2B | 25.0 | 12.40 | 2 1/2 x 3 5/8 |
| 5200 | 500C522T250BE2B | 23.6 | 12.60 | 2 x 5 1/8 |
| 5600 | 500C562T250DB2B | 27.6 | 12.60 | 3 x 3 1/8 |
| 5800 | 500C582T250CC2B | 20.7 | 14.30 | 2 1/2 x 4 1/8 |
| 5900 | 500C592T250BF2B | 21.0 | 13.80 | 2 x 5 5/8 |
| 6900 | 500C692T250CD2B | 17.7 | 16.10 | 2 1/2 x 4 5/8 |
| 7200 | 500C722T250DJ2B | 21.6 | 15.00 | 3 x 3 5/8 |
| 7900 | 500C792T250CE2B | 15.5 | 17.70 | 2 1/2 x 5 1/8 |
| 8800 | 500C882T250DC2B | 17.6 | 17.30 | 3 x 4 1/8 |
| 9000 | 500C902T250CF2B | 13.8 | 19.40 | 2 1/2 x 5 5/8 |
| 10000 | 500C103T250DD2B | 16.3 | 18.60 | 3 x 4 5/8 |
| 11000 | 500C113T250FC2D | 19.5 | 18.10 | 3 1/2 x 4 1/8 |
| 12000 | 500C123T250DE2B | 14.3 | 20.60 | 3 x 5 1/8 |
| 13000 | 500C133T250FD2D | 17.2 | 19.90 | 3 1/2 x 4 5/8 |
| 14000 | 500C143T250DF2B | 12.0 | 23.20 | 3 x 5 5/8 |
| 15000 | 500C153T250DP2B | 11.5 | 23.90 | 3 x 5 7/8 |
| 15000 | 500C153T250FE2D | 15.1 | 22.00 | 3 1/2 x 5 1/8 |
| 17000 | 500C173T250FF2D | 13.2 | 24.20 | 3 1/2 x 5 5/8 |
| 18000 | 500C183T250FP2D | 12.8 | 24.80 | 3 1/2 x 5 7/8 |
| 21000 | 500C213T250DN2D | 9.6 | 30.90 | 3 x 7 5/8 |
| 24000 | 500C243T250DG2D | 7.0 | 34.60 | 3 x 8 5/8 |
| 25000 | 500C253T250FN2D | 10.5 | 30.00 | 3 1/2 x 7 5/8 |
| 29000 | 500C293T250FG2D | 9.2 | 33.00 | 3 1/2 x 8 5/8 |
| 300 Vdc (350 Vdc Surge) | | | | |
| 290 | 500C291T300AK2B | 418.0 | 1.60 | 1 3/8 x 1 5/8 |
| 520 | 500C521T300AA2B | 231.0 | 2.30 | 1 3/8 x 2 1/8 |
| 630 | 500C631T300AH2B | 189.0 | 2.80 | 1 3/8 x 2 5/8 |
| 870 | 500C871T300AB2B | 138.0 | 3.50 | 1 3/8 x 3 1/8 |
| 870 | 500C871T300EA2B | 139.0 | 3.50 | 1 3/4 x 2 1/8 |
| 1000 | 500C102T300BA2B | 131.0 | 3.90 | 2 x 2 1/8 |
| 1100 | 500C112T300AJ2B | 107.0 | 4.20 | 1 3/8 x 3 5/8 |
| 1100 | 500C112T300EH2B | 117.0 | 4.10 | 1 3/4 x 2 5/8 |

| Cap. (µF) | Catalog Part Number | ESR Max. @ 25 °C 120 Hz (mΩ) | Ripple Max. @ 85°C 120 Hz (A) | Nominal Size D x L (inches) |
|--------------------------------|---------------------|------------------------------|-------------------------------|-----------------------------|
| 1300 | 500C132T300AC2B | 90.4 | 4.80 | 1 3/8 x 4 1/8 |
| 1300 | 500C132T300BH2B | 103.0 | 4.80 | 2 x 2 5/8 |
| 1400 | 500C142T300EB2B | 84.5 | 5.20 | 1 3/4 x 3 1/8 |
| 1600 | 500C162T300AD2B | 77.4 | 5.40 | 1 3/8 x 4 5/8 |
| 1800 | 500C182T300AE2B | 65.7 | 6.10 | 1 3/8 x 5 1/8 |
| 1800 | 500C182T300EJ2B | 68.3 | 6.10 | 1 3/4 x 3 5/8 |
| 1900 | 500C192T300BB2B | 71.1 | 6.10 | 2 x 3 1/8 |
| 2000 | 500C202T300AF2B | 60.3 | 6.60 | 1 3/8 x 5 5/8 |
| 2200 | 500C222T300EC2B | 56.7 | 7.00 | 1 3/4 x 4 1/8 |
| 2200 | 500C222T300CH2B | 60.5 | 7.20 | 2 1/2 x 2 5/8 |
| 2400 | 500C242T300BJ2B | 55.5 | 7.30 | 2 x 3 5/8 |
| 2600 | 500C262T300ED2B | 48.5 | 7.90 | 1 3/4 x 4 5/8 |
| 2900 | 500C292T300BC2B | 45.7 | 8.40 | 2 x 4 1/8 |
| 2900 | 500C292T300CB2B | 46.5 | 8.70 | 2 1/2 x 3 1/8 |
| 3000 | 500C302T300EE2B | 42.5 | 8.70 | 1 3/4 x 5 1/8 |
| 3400 | 500C342T300EF2B | 37.9 | 9.50 | 1 3/4 x 5 5/8 |
| 3500 | 500C352T300BD2B | 38.9 | 9.50 | 2 x 4 5/8 |
| 3700 | 500C372T300CJ2B | 38.1 | 10.10 | 2 1/2 x 3 5/8 |
| 4000 | 500C402T300BE2B | 34.0 | 10.50 | 2 x 5 1/8 |
| 4100 | 500C412T300DB2B | 42.8 | 10.10 | 3 x 3 1/8 |
| 4500 | 500C452T300BF2B | 30.2 | 11.50 | 2 x 5 5/8 |
| 4500 | 500C452T300CC2B | 29.9 | 11.90 | 2 1/2 x 4 1/8 |
| 5200 | 500C522T300DJ2B | 34.0 | 11.90 | 3 x 3 5/8 |
| 5300 | 500C532T300CD2B | 25.5 | 13.40 | 2 1/2 x 4 5/8 |
| 6100 | 500C612T300CE2B | 22.2 | 14.80 | 2 1/2 x 5 1/8 |
| 6400 | 500C642T300DC2B | 26.2 | 14.20 | 3 x 4 1/8 |
| 6900 | 500C692T300CF2B | 19.8 | 16.20 | 2 1/2 x 5 5/8 |
| 7500 | 500C752T300DD2B | 23.6 | 15.50 | 3 x 4 5/8 |
| 8700 | 500C872T300DE2B | 20.5 | 17.20 | 3 x 5 1/8 |
| 8900 | 500C892T300FC2D | 21.0 | 17.40 | 3 1/2 x 4 1/8 |
| 9800 | 500C982T300DF2B | 18.0 | 18.90 | 3 x 5 5/8 |
| 10000 | 500C103T300DP2B | 17.0 | 19.70 | 3 x 5 7/8 |
| 10000 | 500C103T300FD2D | 18.2 | 19.40 | 3 1/2 x 4 5/8 |
| 12000 | 500C123T300FE2D | 16.0 | 21.30 | 3 1/2 x 5 1/8 |
| 13000 | 500C133T300FF2D | 14.3 | 23.20 | 3 1/2 x 5 5/8 |
| 14000 | 500C143T300FP2D | 13.5 | 24.20 | 3 1/2 x 5 7/8 |
| 15000 | 500C153T300DN2B | 13.2 | 24.90 | 3 x 7 5/8 |
| 17000 | 500C173T300DG2B | 10.8 | 27.90 | 3 x 8 5/8 |
| 19000 | 500C193T300FN2D | 11.0 | 29.50 | 3 1/2 x 7 5/8 |
| 22000 | 500C223T300FG2D | 9.3 | 32.60 | 3 1/2 x 8 5/8 |
| 350 Vdc (400 Vdc Surge) | | | | |
| 200 | 500C201T350AK2B | 605.0 | 1.30 | 1 3/8 x 1 5/8 |
| 320 | 500C321T350AA2B | 379.0 | 1.80 | 1 3/8 x 2 1/8 |
| 470 | 500C471T350AH2B | 253.0 | 2.40 | 1 3/8 x 2 5/8 |
| 630 | 500C631T350AB2B | 190.0 | 3.00 | 1 3/8 x 3 1/8 |
| 720 | 500C721T350EA2B | 177.0 | 3.10 | 1 3/4 x 2 1/8 |
| 770 | 500C771T350EH2B | 162.0 | 3.50 | 1 3/4 x 2 5/8 |
| 790 | 500C791T350AJ2B | 153.0 | 3.50 | 1 3/8 x 3 5/8 |
| 790 | 500C791T350BA2B | 168.0 | 3.50 | 2 x 2 1/8 |

Type 500C 95 °C Long-Life, Screw Terminal, Aluminum Electrolytic

| Cap. (µF) | Catalog Part Number | ESR Max. @ 25 °C 120 Hz (mΩ) | Ripple Max. @ 85°C 120 Hz (A) | Nominal Size D x L (inches) |
|--------------------------------|---------------------|------------------------------|-------------------------------|-----------------------------|
| 950 | 500C951T350AC2B | 127.0 | 4.00 | 1 3/8 x 4 1/8 |
| 970 | 500C971T350BH2B | 132.0 | 4.20 | 2 x 2 5/8 |
| 990 | 500C991T350EB2B | 125.0 | 4.30 | 1 3/4 x 3 1/8 |
| 1100 | 500C112T350AD2B | 110.0 | 4.50 | 1 3/8 x 4 5/8 |
| 1300 | 500C132T350AE2B | 96.3 | 5.00 | 1 3/8 x 5 1/8 |
| 1300 | 500C132T350EJ2B | 97.3 | 5.10 | 1 3/4 x 3 5/8 |
| 1300 | 500C132T350BB2B | 101.0 | 5.10 | 2 x 3 1/8 |
| 1400 | 500C142T350AF2B | 85.9 | 5.50 | 1 3/8 x 5 5/8 |
| 1500 | 500C152T350CH2B | 86.9 | 6.00 | 2 1/2 x 2 5/8 |
| 1600 | 500C162T350EC2B | 79.9 | 5.90 | 1 3/4 x 4 1/8 |
| 1600 | 500C162T350BJ2B | 79.2 | 6.10 | 2 x 3 5/8 |
| 1800 | 500C182T350ED2B | 67.8 | 6.60 | 1 3/4 x 4 5/8 |
| 2000 | 500C202T350BC2B | 65.1 | 7.00 | 2 x 4 1/8 |
| 2100 | 500C212T350EE2B | 59.1 | 7.40 | 1 3/4 x 5 1/8 |
| 2100 | 500C212T350CB2B | 61.0 | 7.60 | 2 1/2 x 3 1/8 |
| 2300 | 500C232T350BD2B | 55.4 | 8.00 | 2 x 4 5/8 |
| 2400 | 500C242T350EF2B | 52.4 | 8.10 | 1 3/4 x 5 5/8 |
| 2700 | 500C272T350BE2B | 48.3 | 8.80 | 2 x 5 1/8 |
| 2700 | 500C272T350CJ2B | 48.5 | 8.90 | 2 1/2 x 3 5/8 |
| 2900 | 500C292T350DB2B | 54.0 | 9.00 | 3 x 3 1/8 |
| 3100 | 500C312T350BF2B | 42.8 | 9.70 | 2 x 5 5/8 |
| 3300 | 500C332T350CC2B | 39.9 | 10.30 | 2 1/2 x 4 1/8 |
| 3700 | 500C372T350DJ2B | 41.7 | 10.80 | 3 x 3 5/8 |
| 3900 | 500C392T350CD2B | 34.0 | 11.60 | 2 1/2 x 4 5/8 |
| 4500 | 500C452T350CE2B | 29.6 | 12.80 | 2 1/2 x 5 1/8 |
| 4600 | 500C462T350DC2B | 34.7 | 12.30 | 3 x 4 1/8 |
| 5100 | 500C512T350CF2B | 26.2 | 14.10 | 2 1/2 x 5 5/8 |
| 5400 | 500C542T350DD2B | 29.6 | 13.90 | 3 x 4 5/8 |
| 6200 | 500C622T350DE2B | 25.8 | 15.30 | 3 x 5 1/8 |
| 6400 | 500C642T350FC2D | 29.9 | 14.60 | 3 1/2 x 4 1/8 |
| 7000 | 500C702T350DF2B | 22.9 | 16.70 | 3 x 5 5/8 |
| 7500 | 500C752T350DP2B | 21.7 | 17.40 | 3 x 5 7/8 |
| 7500 | 500C752T350FD2D | 25.7 | 16.30 | 3 1/2 x 4 5/8 |
| 8700 | 500C872T350FE2D | 22.5 | 18.00 | 3 1/2 x 5 1/8 |
| 9800 | 500C982T350FF2D | 20.0 | 19.60 | 3 1/2 x 5 5/8 |
| 10000 | 500C103T350DN2B | 17.1 | 21.80 | 3 x 7 5/8 |
| 10000 | 500C103T350FP2D | 18.9 | 20.40 | 3 1/2 x 5 7/8 |
| 12000 | 500C123T350DG2B | 14.2 | 24.30 | 3 x 8 5/8 |
| 15000 | 500C153T350FN2D | 14.9 | 25.40 | 3 1/2 x 7 5/8 |
| 17000 | 500C173T350FG2D | 12.4 | 28.30 | 3 1/2 x 8 5/8 |
| 400 Vdc (450 Vdc Surge) | | | | |
| 160 | 500C161T400AK2B | 652.0 | 1.30 | 1 3/8 x 1 5/8 |
| 250 | 500C251T400AA2B | 408.0 | 1.80 | 1 3/8 x 2 1/8 |
| 380 | 500C381T400AH2B | 273.0 | 2.30 | 1 3/8 x 2 5/8 |
| 500 | 500C501T400AB2B | 205.0 | 2.90 | 1 3/8 x 3 1/8 |
| 570 | 500C571T400EA2B | 189.0 | 3.00 | 1 3/4 x 2 1/8 |
| 610 | 500C611T400EH2B | 174.0 | 3.40 | 1 3/4 x 2 5/8 |
| 630 | 500C631T400AJ2B | 164.0 | 3.40 | 1 3/8 x 3 5/8 |
| 630 | 500C631T400BA2B | 179.0 | 3.40 | 2 x 2 1/8 |

| Cap. (µF) | Catalog Part Number | ESR Max. @ 25 °C 120 Hz (mΩ) | Ripple Max. @ 85°C 120 Hz (A) | Nominal Size D x L (inches) |
|--------------------------------|---------------------|------------------------------|-------------------------------|-----------------------------|
| 750 | 500C751T400AC2B | 137.0 | 3.90 | 1 3/8 x 4 1/8 |
| 780 | 500C781T400BH2B | 142.0 | 4.10 | 2 x 2 5/8 |
| 790 | 500C791T400EB2B | 134.0 | 4.10 | 1 3/4 x 3 1/8 |
| 880 | 500C881T400AD2B | 118.0 | 4.40 | 1 3/8 x 4 5/8 |
| 1000 | 500C102T400AE2B | 104.0 | 4.90 | 1 3/8 x 5 1/8 |
| 1000 | 500C102T400EJ2B | 105.0 | 4.90 | 1 3/4 x 3 5/8 |
| 1000 | 500C102T400BB2B | 109.0 | 5.00 | 2 x 3 1/8 |
| 1100 | 500C112T400AF2B | 92.4 | 5.30 | 1 3/8 x 5 5/8 |
| 1200 | 500C122T400EC2B | 85.8 | 5.70 | 1 3/4 x 4 1/8 |
| 1200 | 500C122T400CH2B | 93.1 | 5.80 | 2 1/2 x 2 5/8 |
| 1300 | 500C132T400BJ2B | 85.0 | 5.90 | 2 x 3 5/8 |
| 1500 | 500C152T400ED2B | 72.9 | 6.40 | 1 3/4 x 4 5/8 |
| 1600 | 500C162T400BC2B | 69.8 | 6.80 | 2 x 4 1/8 |
| 1700 | 500C172T400EE2B | 63.4 | 7.10 | 1 3/4 x 5 1/8 |
| 1700 | 500C172T400CB2B | 65.3 | 7.30 | 2 1/2 x 3 1/8 |
| 1900 | 500C192T400EF2B | 56.2 | 7.80 | 1 3/4 x 5 5/8 |
| 1900 | 500C192T400BD2B | 59.3 | 7.70 | 2 x 4 5/8 |
| 2100 | 500C212T400BE2B | 51.7 | 8.50 | 2 x 5 1/8 |
| 2100 | 500C212T400CJ2B | 52.0 | 8.60 | 2 1/2 x 3 5/8 |
| 2300 | 500C232T400DB2B | 57.5 | 8.80 | 3 x 3 1/8 |
| 2400 | 500C242T400BF2B | 45.9 | 9.30 | 2 x 5 5/8 |
| 2600 | 500C262T400CC2B | 42.8 | 9.90 | 2 1/2 x 4 1/8 |
| 3000 | 500C302T400DJ2B | 44.9 | 10.40 | 3 x 3 5/8 |
| 3100 | 500C312T400CD2B | 35.6 | 11.30 | 2 1/2 x 4 5/8 |
| 3500 | 500C352T400CE2B | 31.7 | 12.40 | 2 1/2 x 5 1/8 |
| 3600 | 500C362T400DC2B | 37.0 | 11.90 | 3 x 4 1/8 |
| 4000 | 500C402T400CF2B | 31.5 | 12.80 | 2 1/2 x 5 5/8 |
| 4300 | 500C432T400DD2B | 28.1 | 14.20 | 3 x 4 5/8 |
| 4900 | 500C492T400DE2B | 27.4 | 14.80 | 3 x 5 1/8 |
| 5100 | 500C512T400FC2D | 31.9 | 14.10 | 3 1/2 x 4 1/8 |
| 5600 | 500C562T400DF2B | 24.4 | 16.20 | 3 x 5 5/8 |
| 5900 | 500C592T400DP2B | 23.1 | 16.90 | 3 x 5 7/8 |
| 6000 | 500C602T400FD2D | 27.4 | 15.80 | 3 1/2 x 4 5/8 |
| 6900 | 500C692T400FE2D | 23.9 | 17.50 | 3 1/2 x 5 1/8 |
| 7800 | 500C782T400FF2D | 21.2 | 19.00 | 3 1/2 x 5 5/8 |
| 8200 | 500C822T400DN2B | 18.2 | 21.20 | 3 x 7 5/8 |
| 8300 | 500C832T400FP2D | 20.1 | 19.80 | 3 1/2 x 5 7/8 |
| 9500 | 500C952T400DG2B | 15.1 | 23.60 | 3 x 8 5/8 |
| 11000 | 500C113T400FN2D | 15.8 | 24.70 | 3 1/2 x 7 5/8 |
| 13000 | 500C133T400FG2D | 13.1 | 27.50 | 3 1/2 x 8 5/8 |
| 450 Vdc (500 Vdc Surge) | | | | |
| 140 | 500C141T450AK2B | 797.0 | 1.10 | 1 3/8 x 1 5/8 |
| 220 | 500C221T450AA2B | 438.0 | 1.70 | 1 3/8 x 2 1/8 |
| 330 | 500C331T450AH2B | 337.0 | 2.10 | 1 3/8 x 2 5/8 |
| 420 | 500C421T450EA2B | 264.0 | 2.60 | 1 3/4 x 2 1/8 |
| 440 | 500C441T450AB2B | 253.0 | 2.60 | 1 3/8 x 3 1/8 |
| 520 | 500C521T450EH2B | 213.0 | 3.10 | 1 3/4 x 2 5/8 |
| 550 | 500C551T450AJ2B | 203.0 | 3.10 | 1 3/8 x 3 5/8 |
| 550 | 500C551T450BA2B | 228.0 | 3.00 | 2 x 2 1/8 |

Type 500C 95 °C Long-Life, Screw Terminal, Aluminum Electrolytic

| Cap. (µF) | Catalog Part Number | ESR Max. @ 25 °C 120 Hz (mΩ) | Ripple Max. @ 85°C 120 Hz (A) | Nominal Size D x L (inches) | Cap. (µF) | Catalog Part Number | ESR Max. @ 25 °C 120 Hz (mΩ) | Ripple Max. @ 85°C 120 Hz (A) | Nominal Size D x L (inches) |
|--------------------------------|---------------------|---------------------------------|----------------------------------|--------------------------------|--------------------------------|---------------------|---------------------------------|----------------------------------|--------------------------------|
| 660 | 500C661T450AC2B | 169.0 | 3.50 | 1 3/8 x 4 1/8 | 470 | 500C471T500BH2B | 274.0 | 2.90 | 2 x 2 5/8 |
| 670 | 500C671T450EB2B | 165.0 | 3.70 | 1 3/4 x 3 1/8 | 480 | 500C481T500EB2B | 265.0 | 2.90 | 1 3/4 x 3 1/8 |
| 680 | 500C681T450BH2B | 178.0 | 3.60 | 2 x 2 5/8 | 530 | 500C531T500AD2B | 261.0 | 2.90 | 1 3/8 x 4 5/8 |
| 760 | 500C761T450AD2B | 146.0 | 3.90 | 1 3/8 x 4 5/8 | 610 | 500C611T500AE2B | 231.0 | 3.30 | 1 3/8 x 5 1/8 |
| 870 | 500C871T450AE2B | 128.0 | 4.40 | 1 3/8 x 5 1/8 | 620 | 500C621T500EJ2B | 202.0 | 3.50 | 1 3/4 x 3 5/8 |
| 870 | 500C871T450EJ2B | 131.0 | 4.40 | 1 3/4 x 3 5/8 | 650 | 500C651T500BB2B | 200.0 | 3.70 | 2 x 3 1/8 |
| 870 | 500C871T450BB2B | 137.0 | 4.40 | 2 x 3 1/8 | 690 | 500C691T500AF2B | 195.0 | 3.70 | 1 3/8 x 5 5/8 |
| 980 | 500C981T450AF2B | 114.0 | 4.80 | 1 3/8 x 5 5/8 | 760 | 500C761T500EC2B | 169.0 | 4.00 | 1 3/4 x 4 1/8 |
| 1100 | 500C112T450EC2B | 107.0 | 5.10 | 1 3/4 x 4 1/8 | 770 | 500C771T500CH2B | 171.0 | 4.30 | 2 1/2 x 2 5/8 |
| 1100 | 500C112T450BJ2B | 109.0 | 5.20 | 2 x 3 5/8 | 840 | 500C841T500BJ2B | 156.0 | 4.40 | 2 x 3 5/8 |
| 1100 | 500C112T450CH2B | 116.0 | 5.20 | 2 1/2 x 2 5/8 | 890 | 500C891T500ED2B | 143.0 | 4.60 | 1 3/4 x 4 5/8 |
| 1300 | 500C132T450ED2B | 91.1 | 5.70 | 1 3/4 x 4 5/8 | 960 | 500C961T500BC2B | 136.0 | 4.90 | 2 x 4 1/8 |
| 1400 | 500C142T450EE2B | 79.2 | 6.40 | 1 3/4 x 5 1/8 | 1000 | 500C102T500EE2B | 125.0 | 5.10 | 1 3/4 x 5 1/8 |
| 1400 | 500C142T450BC2B | 89.5 | 6.00 | 2 x 4 1/8 | 1100 | 500C112T500BD2B | 115.0 | 5.50 | 2 x 4 5/8 |
| 1500 | 500C152T450CB2B | 81.1 | 6.60 | 2 1/2 x 3 1/8 | 1100 | 500C112T500CB2B | 122.0 | 5.40 | 2 1/2 x 3 1/8 |
| 1600 | 500C162T450EF2B | 70.2 | 7.00 | 1 3/4 x 5 5/8 | 1200 | 500C122T500EF2B | 110.0 | 5.60 | 1 3/4 x 5 5/8 |
| 1600 | 500C162T450BD2B | 76.0 | 6.80 | 2 x 4 5/8 | 1300 | 500C132T500BE2B | 100.0 | 6.10 | 2 x 5 1/8 |
| 1900 | 500C192T450BE2B | 66.1 | 7.50 | 2 x 5 1/8 | 1400 | 500C142T500CJ2B | 95.1 | 6.40 | 2 1/2 x 3 5/8 |
| 1900 | 500C192T450CJ2B | 66.5 | 7.60 | 2 1/2 x 3 5/8 | 1500 | 500C152T500BF2B | 88.9 | 6.70 | 2 x 5 5/8 |
| 2100 | 500C212T450BF2B | 58.6 | 8.30 | 2 x 5 5/8 | 1600 | 500C162T500DB2B | 86.4 | 7.10 | 3 x 3 1/8 |
| 2100 | 500C212T450DB2B | 63.8 | 8.30 | 3 x 3 1/8 | 1700 | 500C172T500CC2B | 78.1 | 7.40 | 2 1/2 x 4 1/8 |
| 2400 | 500C242T450CC2B | 54.7 | 8.80 | 2 1/2 x 4 1/8 | 2000 | 500C202T500CD2B | 66.3 | 8.30 | 2 1/2 x 4 5/8 |
| 2700 | 500C272T450DJ2B | 49.8 | 9.90 | 3 x 3 5/8 | 2100 | 500C212T500DJ2B | 67.4 | 8.50 | 3 x 3 5/8 |
| 2800 | 500C282T450CD2B | 46.4 | 9.90 | 2 1/2 x 4 5/8 | 2200 | 500C222T500CE2B | 61.1 | 8.90 | 2 1/2 x 5 1/8 |
| 3200 | 500C322T450CE2B | 40.4 | 11.00 | 2 1/2 x 5 1/8 | 2400 | 500C242T500CF2B | 54.7 | 9.70 | 2 1/2 x 5 5/8 |
| 3300 | 500C332T450DC2B | 38.2 | 11.80 | 3 x 4 1/8 | 2400 | 500C242T500DC2B | 55.4 | 9.80 | 3 x 4 1/8 |
| 3600 | 500C362T450CF2B | 35.4 | 12.10 | 2 1/2 x 5 5/8 | 2800 | 500C282T500DD2B | 48.1 | 10.90 | 3 x 4 5/8 |
| 3900 | 500C392T450DD2B | 35.7 | 12.60 | 3 x 4 5/8 | 3300 | 500C332T500DE2B | 43.1 | 11.80 | 3 x 5 1/8 |
| 4500 | 500C452T450DE2B | 30.9 | 14.00 | 3 x 5 1/8 | 3400 | 500C342T500FC2D | 40.1 | 12.60 | 3 1/2 x 4 1/8 |
| 4600 | 500C462T450FC2D | 30.3 | 14.50 | 3 1/2 x 4 1/8 | 3700 | 500C372T500DF2B | 37.5 | 13.10 | 3 x 5 5/8 |
| 5100 | 500C512T450DF2B | 27.4 | 15.30 | 3 x 5 5/8 | 3900 | 500C392T500DP2B | 35.5 | 13.60 | 3 x 5 7/8 |
| 5400 | 500C542T450DP2B | 26.0 | 15.90 | 3 x 5 7/8 | 4000 | 500C402T500FD2D | 34.1 | 14.20 | 3 1/2 x 4 5/8 |
| 5400 | 500C542T450FD2D | 25.7 | 16.30 | 3 1/2 x 4 5/8 | 4600 | 500C462T500FE2D | 30.0 | 15.60 | 3 1/2 x 5 1/8 |
| 6300 | 500C632T450FE2D | 22.4 | 18.00 | 3 1/2 x 5 1/8 | 5200 | 500C522T500FF2D | 28.0 | 16.60 | 3 1/2 x 5 5/8 |
| 7100 | 500C712T450FF2D | 19.9 | 19.70 | 3 1/2 x 5 5/8 | 5400 | 500C542T500DN2B | 27.9 | 17.10 | 3 x 7 5/8 |
| 7500 | 500C752T450FP2D | 18.8 | 20.50 | 3 1/2 x 5 7/8 | 5500 | 500C552T500FP2D | 26.0 | 17.40 | 3 1/2 x 5 7/8 |
| 7500 | 500C752T450DN2B | 20.3 | 20.00 | 3 x 7 5/8 | 6300 | 500C632T500DG2B | 23.1 | 19.10 | 3 x 8 5/8 |
| 8700 | 500C872T450DG2B | 16.8 | 22.40 | 3 x 8 5/8 | 7600 | 500C762T500FN2D | 20.5 | 21.80 | 3 1/2 x 7 5/8 |
| 9700 | 500C972T450FN2D | 15.1 | 25.20 | 3 1/2 x 7 5/8 | 8800 | 500C882T500FG2D | 16.7 | 24.40 | 3 1/2 x 8 5/8 |
| 11000 | 500C113T450FG2D | 12.7 | 28.00 | 3 1/2 x 8 5/8 | 550 Vdc (600 Vdc Surge) | | | | |
| 500 Vdc (550 Vdc Surge) | | | | | 1400 | 500C142T550CC2B | 170.5 | 4.90 | 2 1/2 x 4 1/8 |
| 100 | 500C101T500AK2B | 1224.0 | 0.90 | 1 3/8 x 1 5/8 | 1700 | 500C172T550CD2B | 132.6 | 5.90 | 2 1/2 x 4 5/8 |
| 170 | 500C171T500AA2B | 722.0 | 1.30 | 1 3/8 x 2 1/8 | 1900 | 500C192T550CE2B | 111.7 | 6.80 | 2 1/2 x 5.125 |
| 230 | 500C231T500AH2B | 546.0 | 1.70 | 1 3/8 x 2 5/8 | 2200 | 500C222T550DC2B | 90.4 | 7.80 | 3 x 4 1/8 |
| 260 | 500C261T500EA2B | 498.0 | 1.90 | 1 3/4 x 2 1/8 | 2300 | 500C232T550CF2B | 86.5 | 7.80 | 2 1/2 x 5 5/8 |
| 310 | 500C311T500AB2B | 410.0 | 2.00 | 1 3/8 x 3 1/8 | 2500 | 500C252T550DD2B | 79.6 | 8.40 | 3 x 4 5/8 |
| 320 | 500C321T500BA2B | 393.0 | 2.30 | 2 x 2 1/8 | 2900 | 500C292T550DE2B | 64.0 | 9.70 | 3 x 5 1/8 |
| 370 | 500C371T500EH2B | 347.0 | 2.40 | 1 3/4 x 2 5/8 | 3400 | 500C342T550DF2F | 54.6 | 10.90 | 3 x 5 5/8 |
| 380 | 500C381T500AJ2B | 328.0 | 2.40 | 1 3/8 x 3 5/8 | 3700 | 500C372T550DP2B | 50.2 | 12.24 | 3 x 5 7/8 |
| 460 | 500C461T500AC2B | 293.0 | 2.70 | 1 3/8 x 4 1/8 | 5100 | 500C512T550DN2B | 36.4 | 16.22 | 3 x 7 5/8 |