

ASSP for DTS

Piezoelectric VCO (6 to 30 MHz)

M3 Series (E100)

■ DESCRIPTION

The M3 series (E100) of VCO (Voltage Controlled Oscillator) apply to the frequency range 70-300 MHz.

The M3 series uses a single lithium tantalate piezoelectric crystal (LiTaO₃) that has large electromechanical coupling coefficient, and a unique SAW resonator. That provides wide bandwidths, and exceptional stability in VHF band until 300MHz.

■ FEATURES

- Frequency range: 70 to 300MHz
- Wide frequency controllable range: Over than ± 1600 ppm (0.5 to 4.5 V)
- Excellent temperature stability: ± 200 ppm or less (-10 to 70 °C)
- No adjustment is required due to high accuracy oscillation frequency (± 300 ppm or less)
- Highly reliable hermetically sealed package
- High carrier noise ratio: -90dB or less (Detuning; 12.5kHz, bandwidth; 8kHz)
- Small type, and compatible with 8-pin DIP IC

■ PACKAGE

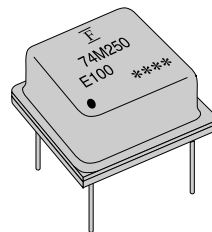

M3 Series (E100)

■ PIN ASSIGNMENT

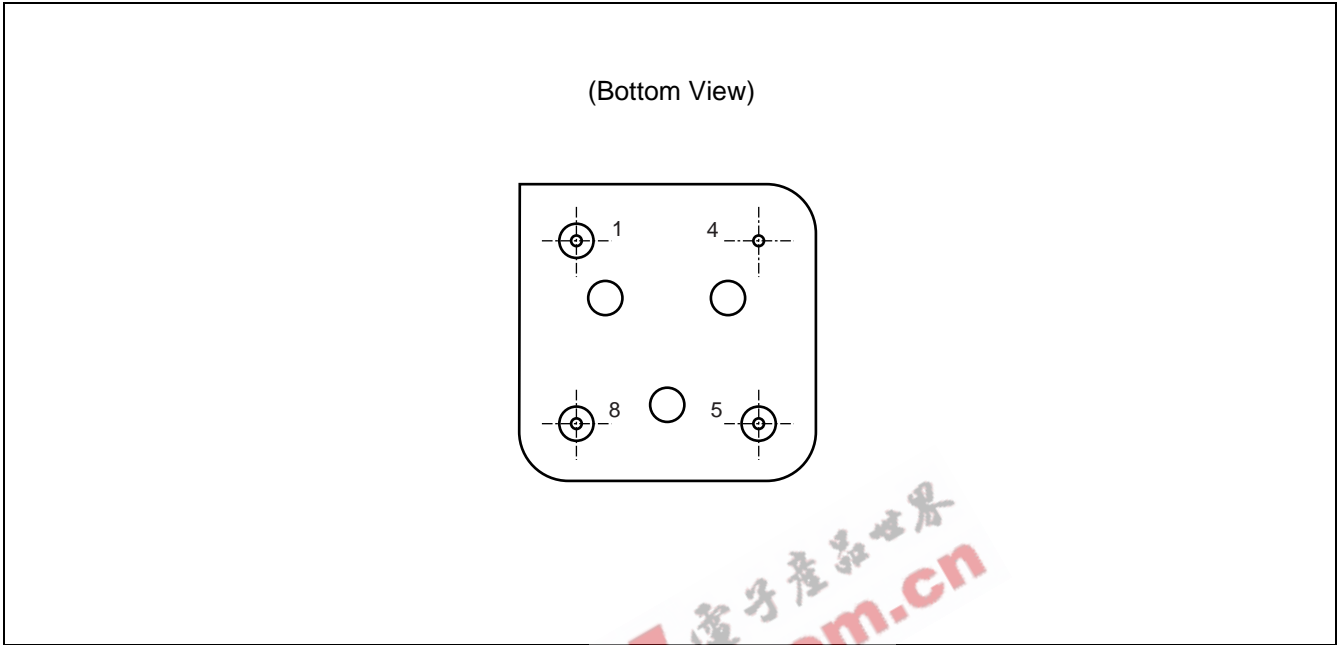

■ PIN DESCRIPTIONS

Pin No.	Symbol	Descriptions
1	V_{IN}	Input (Control voltage)
4	GND	Ground
5	Pout	Output
8	V_{CC}	Supply voltage

M3 Series (E100)

■ ABSOLUTE MAXIMUM RATINGS

Parameter	Symbol	Rating		Unit
		Min.	Max.	
Supply voltage	V _{CC}	-0.5	+7.0	V
Input control voltage	V _{IN}	-0.5	+7.0	V
Operating temperature	T _a	-10	+70	°C
Storage temperature	T _{stg}	-40	+100	°C
Oscillation frequency range	—	70	300	MHz

WARNING: Piezoelectric devices can be permanently damaged by application of stress (voltage, current, temperature, etc.) in excess of absolute maximum ratings. Do not exceed these ratings.

■ RECOMMENDED OPERATING CONDITIONS

Parameter	Symbol	Value		Unit
		Min.	Max.	
Supply voltage	V _{CC}	+4.5	+5.5	V
Input control voltage	V _{IN}	0.0	+5.0	V
Operating temperature	T _a	-10	+70	°C
Control electrode	—	Straight polarity		—

WARNING: The recommended operating conditions are required in order to ensure the normal operation of the piezoelectric device. All of the device's electrical characteristics are warranted when the device is operated within these ranges.

Always use piezoelectric devices within their recommended operating condition ranges. Operation outside these ranges may adversely affect reliability and could result in device failure.

No warranty is made with respect to uses, operating conditions, or combinations not represented on the data sheet. Users considering application outside the listed conditions are advised to contact their FUJITSU representatives beforehand.

■ STANDARD FREQUENCIES

Nominal frequency	Application	Part number
70.0 MHz	Wireless	FAR-M3DC-70M000-E100
74.25 MHz	HDTV	FAR-M3DC-74M250-E100
97.2 MHz	HDTV	FAR-M3DC-97M200-E100
155.52 MHz	B-ISDN	FAR-M3DC-155M52-E100

M3 Series (E100)

■ ELECTRICAL CHARACTERISTICS

Parameter	Symbol	Condition	Value			Unit	Remarks
			Min.	Typ.	Max.		
Supply current	I_{CC}	Without load	—	—	+30	mA	
Deviation of oscillation frequency	f_o	$V_{IN} = 2.5\text{ V}$	-300	—	+300	ppm	Nominal frequency reference
Oscillation frequency	Δf_L	$V_{IN} = 0.5\text{ V}$	—	—	-1600	ppm	$V_{IN} = 2.5\text{ V}$ reference
	Δf_H	$V_{IN} = 4.5\text{ V}$	+1600	—	—	ppm	
Frequency supply voltage stability	$\Delta f (V_{CC})$	$V_{CC} = 5\text{ V} \pm 5\%$	-100	—	+100	ppm	$V_{IN} = 2.5\text{ V}$ $V_{CC} = 5\text{ V}$ reference
Output power	P_{OUT}	$V_{IN} = 2.5\text{ V}$	+2.0	—	—	dBm	50 Ω terminated
Output power stability	ΔP	$V_{IN} = 0.5\text{ to }4.5\text{ V}$	-2	—	+2	dB	$V_{IN} = 2.5\text{ V}$ reference
Frequency stability with temperature	$\Delta f (T_a)$	$T_a = -10\text{ to }70\text{ }^\circ\text{C}$ $V_{IN} = 2.5\text{ V}$	-200	—	+200	ppm	25 $^\circ\text{C}$ reference
Output power stability with temperature	$\Delta P (T_a)$	$T_a = -10\text{ to }70\text{ }^\circ\text{C}$ $V_{IN} = 2.5\text{ V}$	-2	—	+2	dB	25 $^\circ\text{C}$ reference

■ MEASUREMENT CIRCUIT

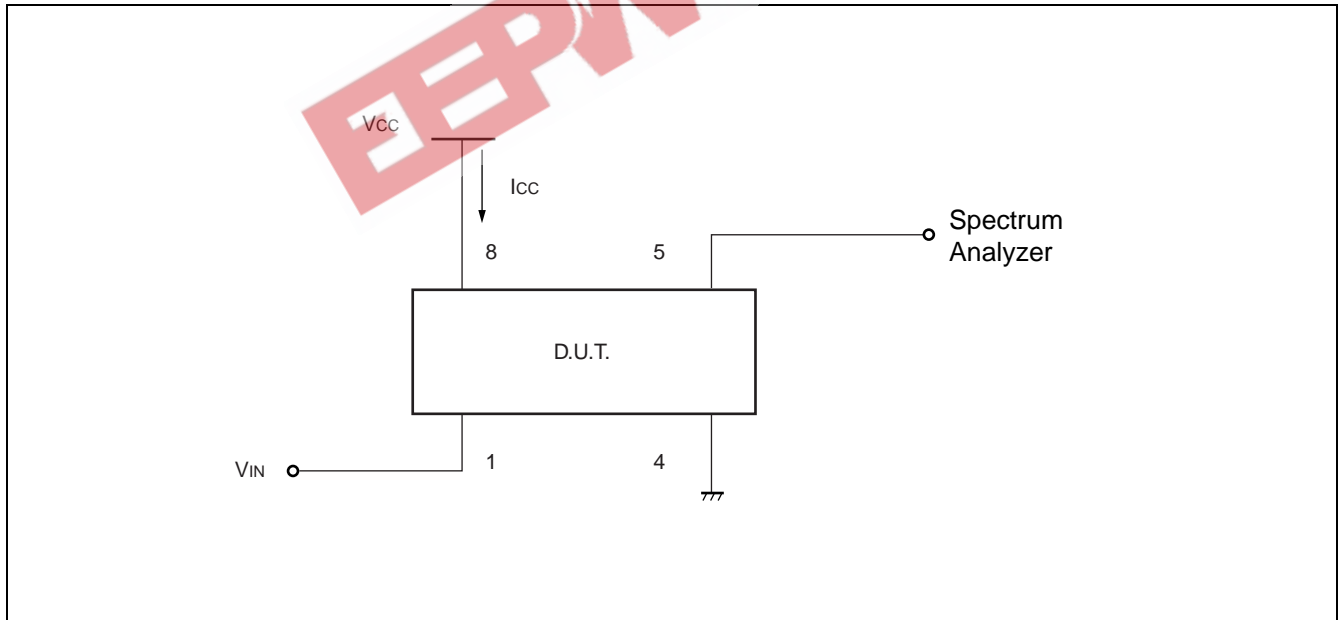

M3 Series (E100)

TYPICAL CHARACTERISTICS

Part number : FAR-M3DC-70M000-E100

1. Control Voltage vs. Oscillation Frequency Variation

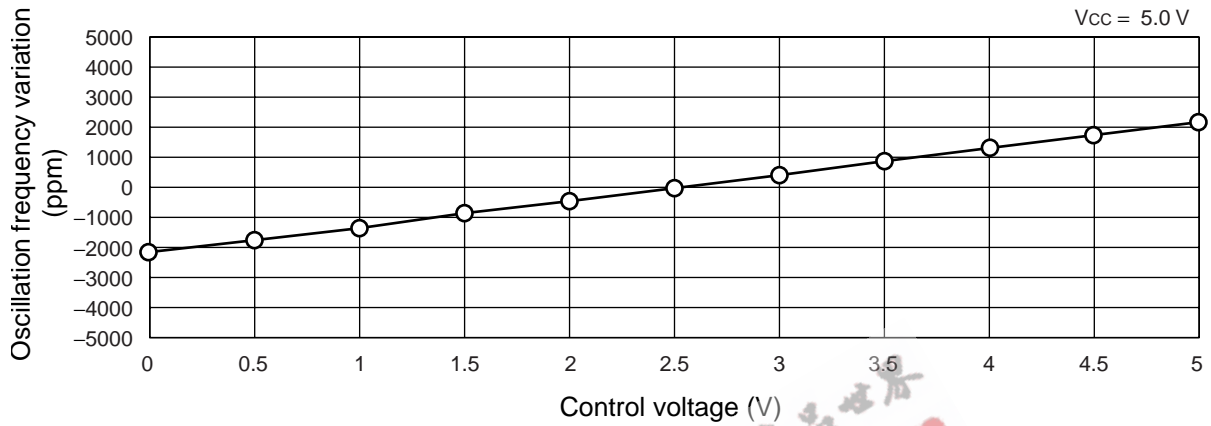

2. Supply Voltage vs. Oscillation Frequency Variation

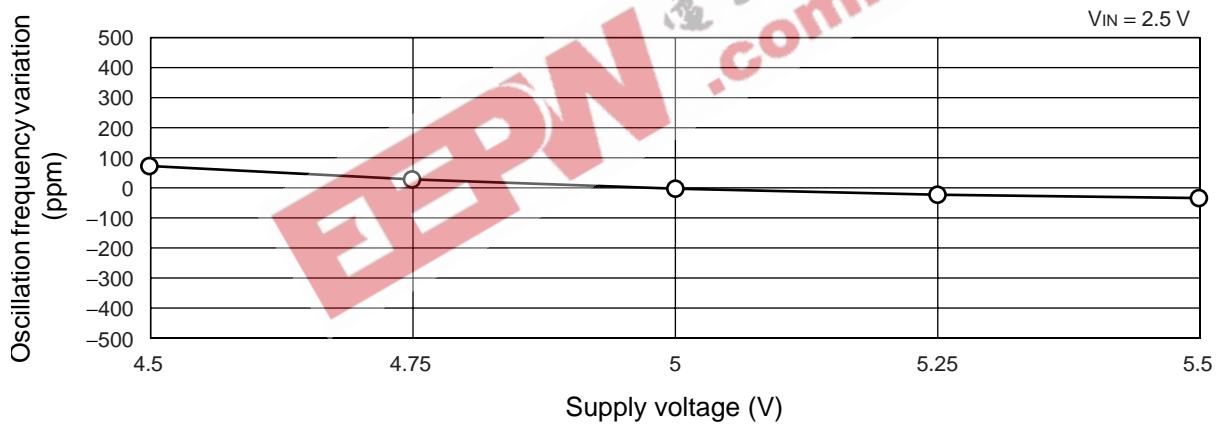

3. Temperature Characteristics

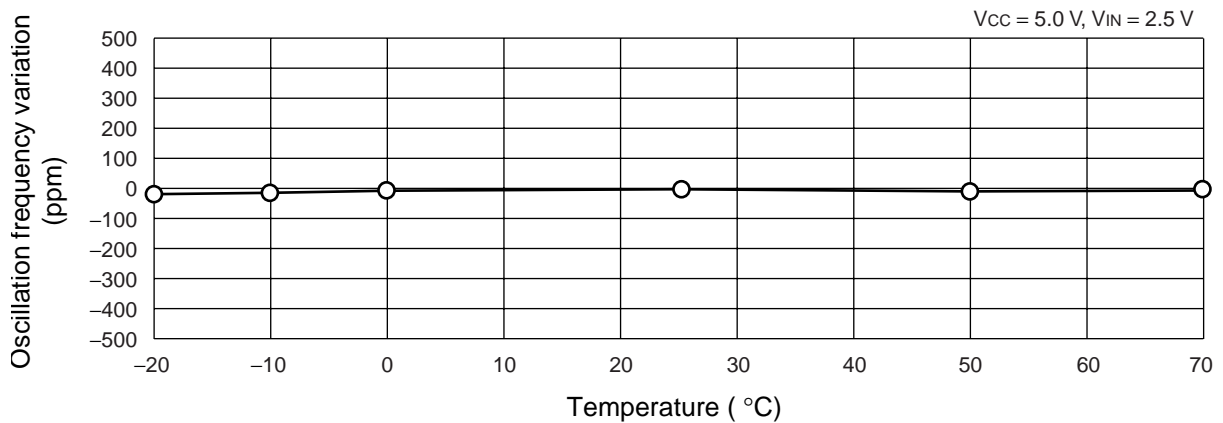

M3 Series (E100)

■ PART NUMBER DESIGNATION

[Designation example]

FAR – M3DC – □□□□□□ – E100
(1) (2)

(1) : Frequency : This specifies the nominal frequency using six alphanumeric characters. M indicates the decimal point.

(2) : Taping : “-R” means 100 pcs/reel

■ MARKING

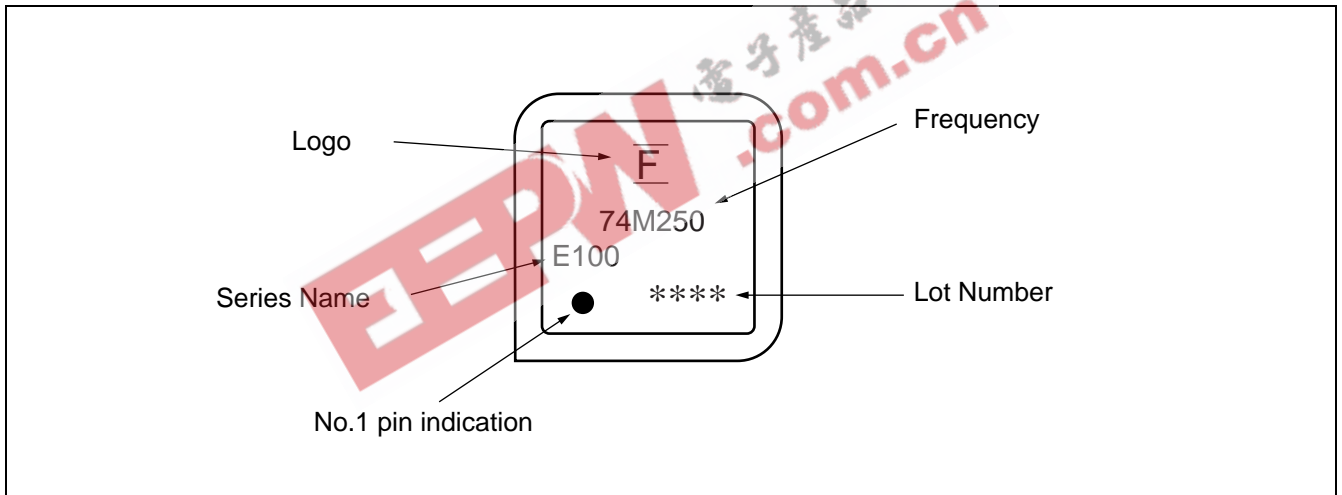

M3 Series (E100)

■ PACKAGE DIMENSION

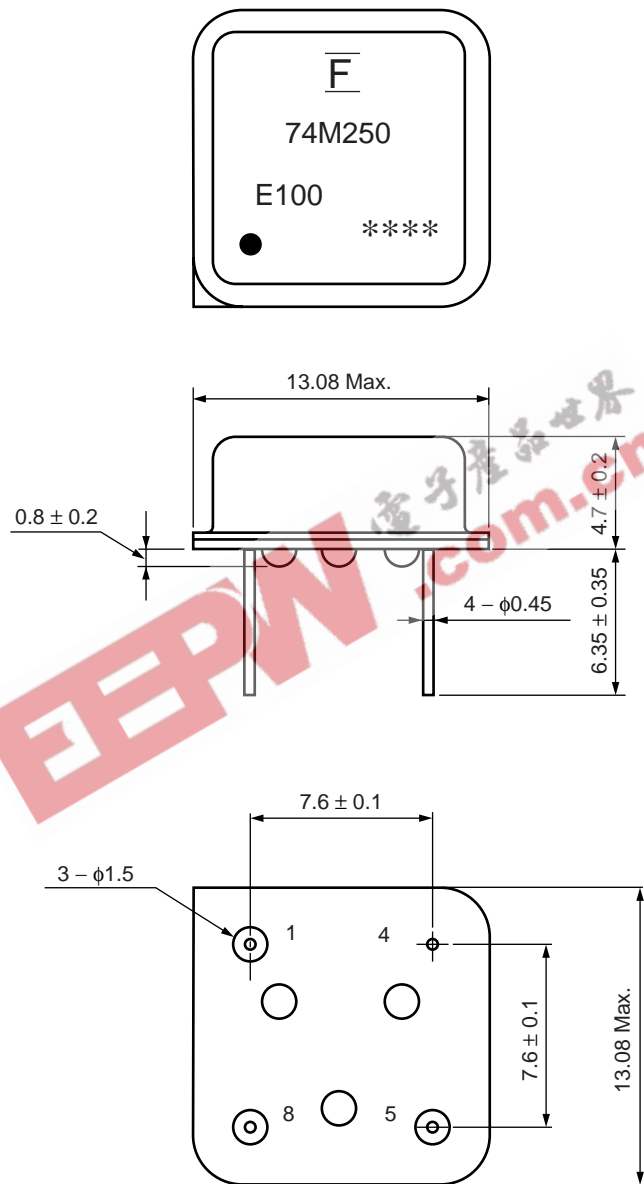

Dimensions in mm.

M3 Series (E100)

FUJITSU MEDIA DEVICES LIMITED

For further information please contact:

Japan

FUJITSU MEDIA DEVICES LIMITED
International Sales and Marketing Dept.
Sin-Yokohama Square Bldg., 14F,
Shin-Yokohama 2-3-12, Kouhoku-ku,
Yokohama-shi, Kanagawa 222-0033, Japan
Tel: +81-45-471-0061
Fax: +81-45-471-0076

<http://www.fujitsu.co.jp/hypertext/fmd/English/index.html>

North and South America

FUJITSU MICROELECTRONICS, INC.
3545 North First Street,
San Jose, CA 95134-1804, U.S.A.
Tel: +1-408-922-9000
Fax: +1-408-922-9179

Customer Response Center
Mon. - Fri.: 7 am - 5 pm (PST)
Tel: +1-800-866-8608
Fax: +1-408-922-9179

<http://www.fujitsumicro.com/>

Europe

FUJITSU MICROELECTRONICS EUROPE GmbH
Am Siebenstein 6-10,
D-63303 Dreieich-Buchschlag,
Germany
Tel: +49-6103-690-0
Fax: +49-6103-690-122

<http://www.fujitsu-fme.com/>

Asia Pacific

FUJITSU MICROELECTRONICS ASIA PTE. LTD.
#05-08, 151 Lorong Chuan,
New Tech Park,
Singapore 556741
Tel: +65-281-0770
Fax: +65-281-0220

<http://www.fmap.com.sg/>

F0010

© FUJITSU LIMITED Printed in Japan

All Rights Reserved.

The contents of this document are subject to change without notice. Customers are advised to consult with FUJITSU sales representatives before ordering.

The information and circuit diagrams in this document are presented as examples of semiconductor device applications, and are not intended to be incorporated in devices for actual use. Also, FUJITSU is unable to assume responsibility for infringement of any patent rights or other rights of third parties arising from the use of this information or circuit diagrams.

The contents of this document may not be reproduced or copied without the permission of FUJITSU LIMITED.

FUJITSU semiconductor devices are intended for use in standard applications (computers, office automation and other office equipments, industrial, communications, and measurement equipments, personal or household devices, etc.).

CAUTION:

Customers considering the use of our products in special applications where failure or abnormal operation may directly affect human lives or cause physical injury or property damage, or where extremely high levels of reliability are demanded (such as aerospace systems, atomic energy controls, sea floor repeaters, vehicle operating controls, medical devices for life support, etc.) are requested to consult with FUJITSU sales representatives before such use. The company will not be responsible for damages arising from such use without prior approval.

Any semiconductor devices have inherently a certain rate of failure. You must protect against injury, damage or loss from such failures by incorporating safety design measures into your facility and equipment such as redundancy, fire protection, and prevention of over-current levels and other abnormal operating conditions.

If any products described in this document represent goods or technologies subject to certain restrictions on export under the Foreign Exchange and Foreign Trade Control Law of Japan, the prior authorization by Japanese government should be required for export of those products from Japan.