

**CNX82A.W, CNX83A.W, SL5582.W & SL5583.W**

**DESCRIPTION**

The CNX82A.W, CNX83A.W, SL5582.W AND SL5583.W, consist of a gallium arsenide infrared emitting diode driving a silicon phototransistor in a 6-pin dual in-line package.

**FEATURES**

- Input/Output pin distance 10.16 mm
- UL recognized (File # E90700)

**APPLICATIONS**

- Power supply regulators
- Digital logic inputs
- Microprocessor inputs

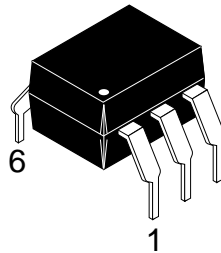

**PACKAGE DIMENSIONS**

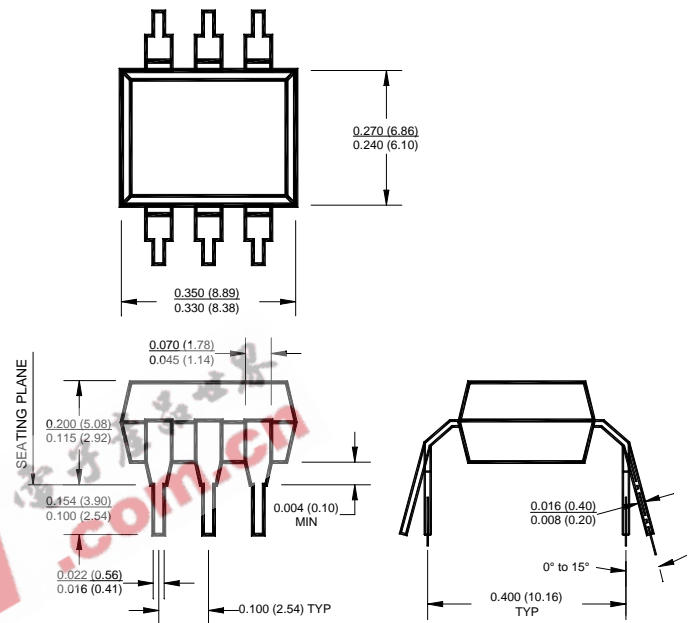

**NOTE**

All dimensions are in inches (millimeters)

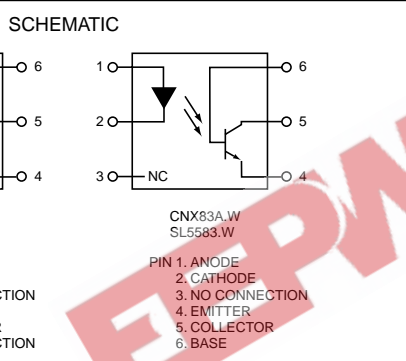

**ABSOLUTE MAXIMUM RATINGS**

Parameter	Symbol	Value	Units
<b>TOTAL DEVICE</b>			
Storage Temperature	$T_{STG}$	-55 to +150	°C
Operating Temperature	$T_{OPR}$	-55 to +100	°C
Lead Solder Temperature	$T_{SOL}$	260 for 10 sec	°C
Junction Temperature	$T_J$	125	°C
Total Device Power Dissipation @ $T_A = 25^\circ\text{C}$	$P_D$	250	mW
<b>EMITTER</b>			
DC/Average Forward Input Current	$I_F$	100	mA
Reverse Input Voltage	$V_R$	5.0	V
Forward Current - Peak (1 $\mu\text{s}$ pulse, 300pps)	$I_F(\text{pk})$	3.0	A
LED Power Dissipation @ $T_A = 25^\circ\text{C}$	$P_D$	140	mW
Derate above 25°C		1.33	mW/°C
<b>DETECTOR</b>			
Collector-Emitter Voltage	$V_{CEO}$	50	V
Collector-Base Voltage (CNX83A)	$V_{CBO}$	70	V
Emitter-Collector Voltage	$V_{ECO}$	7	V
Continuous Collector Current	$I_C$	100	mA
Detector Power Dissipation @ $T_A = 25^\circ\text{C}$	$P_D$	150	mW
Derate above 25°C		2.0	mW/°C

## CNX82A.W, CNX83A.W, SL5582.W & SL5583.W

### ELECTRICAL CHARACTERISTICS (T<sub>A</sub> = 25°C Unless otherwise specified.)

#### INDIVIDUAL COMPONENT CHARACTERISTICS

Parameter	Test Conditions	Symbol	Device	Min	Typ**	Max	Unit
<b>EMITTER</b>							
Input Forward Voltage	(I <sub>F</sub> = 10 mA)	V <sub>F</sub>	ALL		1.2	1.50	V
Reverse Leakage Current	(V <sub>R</sub> = 5.0 V)	I <sub>R</sub>	ALL		0.001	10	μA
<b>DETECTOR</b>							
Collector-Emitter Breakdown Voltage	(I <sub>C</sub> = 1.0 mA, I <sub>F</sub> = 0)	BV <sub>CEO</sub>	ALL	50	100		V
Collector-Base Breakdown Voltage	(I <sub>C</sub> = 100 μA, I <sub>F</sub> = 0)	BV <sub>CBO</sub>	CNX83A.W SL5583.W	70	120		V
Emitter-Collector Breakdown Voltage	(I <sub>E</sub> = 100 μA, I <sub>F</sub> = 0)	BV <sub>ECO</sub>	ALL	7	10		V
Collector-Emitter Dark Current	(V <sub>CE</sub> = 10 V, I <sub>F</sub> = 0)	I <sub>CEO</sub>	ALL		0.001	0.050	μA
	(V <sub>CE</sub> = 10 V, I <sub>F</sub> = 0)		CNX82A.W CNX83A.W		0.5	10	
	(T <sub>A</sub> = 70°C)		SL5582.W SL5583.W			0.5	
	(V <sub>CE</sub> = 10 V, I <sub>F</sub> = 0)		SL5582.W SL5583.W			50	
Collector-Base Dark Current	(V <sub>CB</sub> = 10 V)	I <sub>CBO</sub>	CNX83A.W SL5583.W			20	nA
Capacitance	(V <sub>CE</sub> = 0 V, f = 1 MHz)	C <sub>CE</sub>	ALL		8		pF

Note

\*\* Typical values at T<sub>A</sub> = 25°C

Call QT Optoelectronics for more information or the phone number of your nearest distributor.

United States 800-533-6786 • France 33 [0] 1.45.18.78.78 • Germany 49 [0] 89/96.30.51 • United Kingdom 44 [0] 1296 394499 • Asia/Pacific 603-7352417

**CNX82A.W, CNX83A.W, SL5582.W & SL5583.W**

**TRANSFER CHARACTERISTICS** ( $T_A = 25^\circ\text{C}$  Unless otherwise specified.)

DC Characteristic	Test Conditions	Symbol	Device	Min	Typ**	Max	Units
Current Transfer Ratio, Collector-Emitter	( $I_F = 10\text{ mA}, V_{CE} = 0.4\text{ V}$ )	CTR	ALL	40			%
	(I <sub>F</sub> = 10 mA, V <sub>CE</sub> = 5 V)		CNX82A.W CNX83A.W	40		250	
			SL5582.W SL5583.W	40		320	
	(I <sub>F</sub> = 10 mA, V <sub>CE</sub> = 5 V) (T <sub>A</sub> = 100°C)		SL5582.W SL5583.W	25		320	
			CNX82A.W CNX83A.W	10		100	
	(I <sub>F</sub> = 2 mA, V <sub>CE</sub> = 5 V)		SL5582.W SL5583.W	20			
	(I <sub>F</sub> = 2 mA, V <sub>CE</sub> = 5 V) (T <sub>A</sub> = 100°C)		SL5582.W SL5583.W	15			
Saturation Voltage	(I <sub>F</sub> = 10 mA, I <sub>C</sub> = 4 mA)	V <sub>CE(sat)</sub>	ALL		0.19	0.4	V
Turn-on Time	(I <sub>C</sub> = 2 mA, V <sub>CC</sub> = 5 V, R <sub>L</sub> = 100 Ω)	t <sub>on</sub>	ALL		3		μs
	(I <sub>C</sub> = 2 mA, V <sub>CC</sub> = 5 V, R <sub>L</sub> = 1 kΩ)		ALL		12		
	(I <sub>F</sub> = 16 mA, V <sub>CC</sub> = 5 V, R <sub>L</sub> = 1 kΩ)		SL5582.W SL5583.W			20	
Turn-off Time	(I <sub>C</sub> = 2 mA, V <sub>CC</sub> = 5 V, R <sub>L</sub> = 100 Ω)	t <sub>off</sub>	ALL		3		μs
	(I <sub>C</sub> = 2 mA, V <sub>CC</sub> = 5 V, R <sub>L</sub> = 1 kΩ)		ALL		12		
	(I <sub>F</sub> = 16 mA, V <sub>CC</sub> = 5 V, R <sub>L</sub> = 1 kΩ)		SL5582.W SL5583.W			50	

**ISOLATION CHARACTERISTICS**

Characteristic	Test Conditions	Symbol	Min	Typ**	Max	Units
Input-Output Isolation Voltage	(I <sub>I-O</sub> ≤ 1 μA, 1 min.)	V <sub>ISO</sub>	5300			Vac(rms)
Isolation Resistance	(V <sub>I-O</sub> = 500 VDC)	R <sub>ISO</sub>	10 <sup>11</sup>			Ω
Isolation Capacitance	(V <sub>I-O</sub> = ∅, f = 1 MHz)	C <sub>ISO</sub>		0.5		pf
External air gap (clearance)			9.6			mm
External tracking path (creepage)			8.0			mm
Internal plastic gap (clearance)			1.0			mm

Note  
\*\* Typical values at T<sub>A</sub> = 25°C

**ORDERING INFORMATION**

Option	Order Entry Identifier	Description
300	.300W	VDE 0884

**CNX82A.W, CNX83A.W, SL5582.W & SL5583.W**

**TYPICAL CHARACTERISTICS**

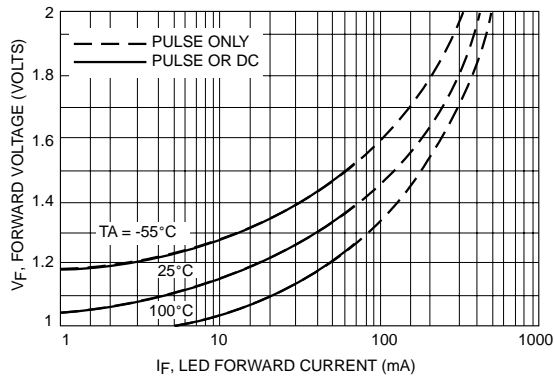

**Figure 1. LED Forward Voltage versus Forward Current**

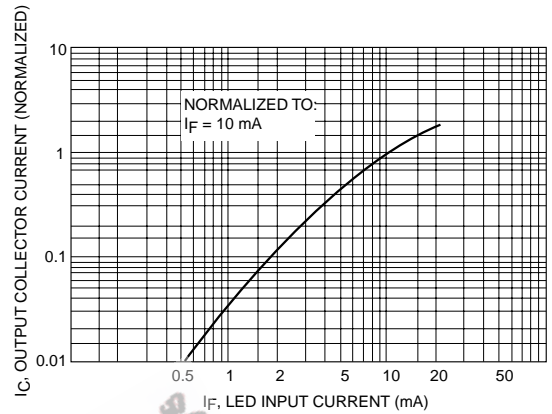

**Figure 2. Output Current versus Input Current**

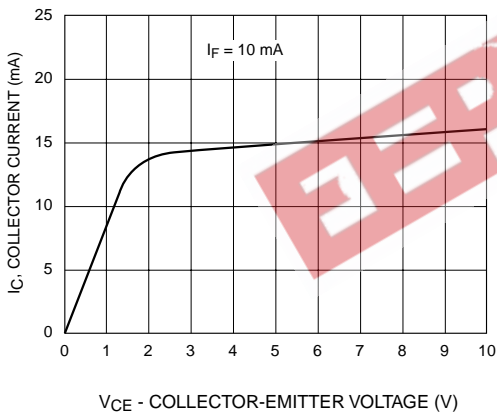

**Figure 3. Collector Current versus  
Collector-Emitter Voltage**

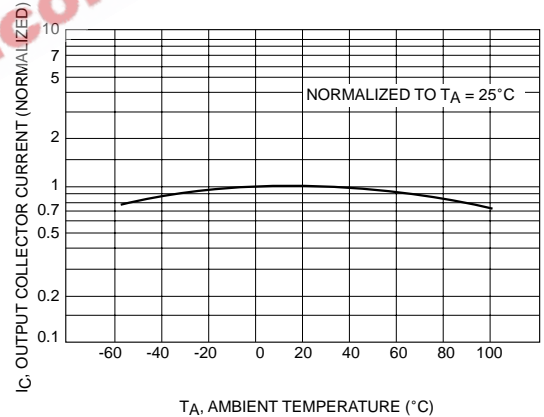

**Figure 4. Output Current versus Ambient Temperature**

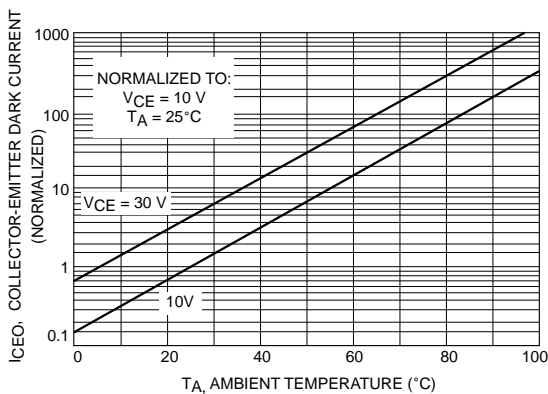

**Figure 5. Dark Current versus Ambient Temperature**

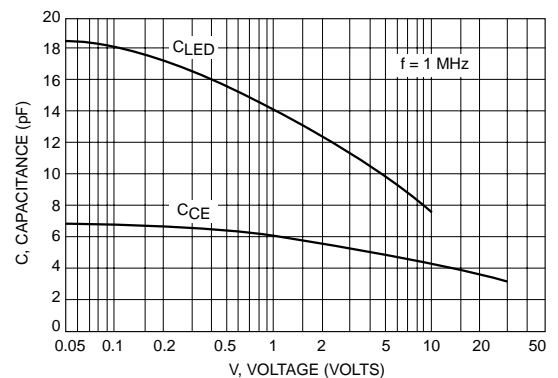

**Figure 6. Capacitance versus Voltage**

**DISCLAIMER**

FAIRCHILD SEMICONDUCTOR RESERVES THE RIGHT TO MAKE CHANGES WITHOUT FURTHER NOTICE TO ANY PRODUCTS HEREIN TO IMPROVE RELIABILITY, FUNCTION OR DESIGN. FAIRCHILD DOES NOT ASSUME ANY LIABILITY ARISING OUT OF THE APPLICATION OR USE OF ANY PRODUCT OR CIRCUIT DESCRIBED HEREIN; NEITHER DOES IT CONVEY ANY LICENSE UNDER ITS PATENT RIGHTS, NOR THE RIGHTS OF OTHERS.

**LIFE SUPPORT POLICY**

FAIRCHILD'S PRODUCTS ARE NOT AUTHORIZED FOR USE AS CRITICAL COMPONENTS IN LIFE SUPPORT DEVICES OR SYSTEMS WITHOUT THE EXPRESS WRITTEN APPROVAL OF THE PRESIDENT OF FAIRCHILD SEMICONDUCTOR CORPORATION. As used herein:

1. Life support devices or systems are devices or systems which, (a) are intended for surgical implant into the body, or (b) support or sustain life, and (c) whose failure to perform when properly used in accordance with instructions for use provided in the labeling, can be reasonably expected to result in a significant injury of the user.
2. A critical component in any component of a life support device or system whose failure to perform can be reasonably expected to cause the failure of the life support device or system, or to affect its safety or effectiveness.

EEPW 电子产品世界  
.com.cn