

Features

- Diffused Junction
- Low Forward Voltage Drop
- High Current Capability
- High Reliability
- High Surge Current Capability

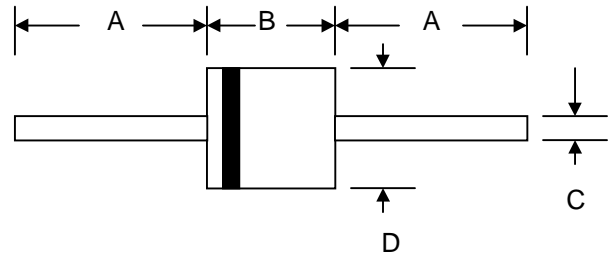

Mechanical Data

- Case: P-600, Molded Plastic
- Terminals: Plated Leads Solderable per MIL-STD-202, Method 208
- Polarity: Cathode Band
- Weight: 2.1 grams (approx.)
- Mounting Position: Any
- Marking: Type Number
- **Lead Free: For RoHS / Lead Free Version, Add “-LF” Suffix to Part Number, See Page 4**

P-600		
Dim	Min	Max
A	25.4	—
B	8.60	9.10
C	1.20	1.30
D	8.60	9.10
All Dimensions in mm		

Maximum Ratings and Electrical Characteristics @ $T_A=25^\circ\text{C}$ unless otherwise specified

Single Phase, half wave, 60Hz, resistive or inductive load.
For capacitive load, derate current by 20%.

Characteristic	Symbol	P600A	P600B	P600D	P600G	P600J	P600K	P600M	Unit
Peak Repetitive Reverse Voltage	V_{RRM}								
Working Peak Reverse Voltage	V_{RWM}	50	100	200	400	600	800	1000	V
DC Blocking Voltage	V_R								
RMS Reverse Voltage	$V_{R(RMS)}$	35	70	140	280	420	560	700	V
Average Rectified Output Current (Note 1) @ $T_A = 60^\circ\text{C}$	I_O	6.0							A
Non-Repetitive Peak Forward Surge Current 8.3ms Single half sine-wave superimposed on rated load (JEDEC Method)	I_{FSM}	400							A
Forward Voltage @ $I_F = 6.0\text{A}$	V_{FM}	1.0							V
Peak Reverse Current @ $T_A = 25^\circ\text{C}$ At Rated DC Blocking Voltage @ $T_A = 100^\circ\text{C}$	I_{RM}	5.0 1.0							μA mA
Typical Junction Capacitance (Note 2)	C_j	150							pF
Typical Thermal Resistance Junction to Ambient (Note 1)	$R_{\theta JA}$	20							$^\circ\text{C/W}$
Operating Temperature Range	T_j	-50 to +150							$^\circ\text{C}$
Storage Temperature Range	T_{STG}	-50 to +150							$^\circ\text{C}$

Note: 1. Leads maintained at ambient temperature at a distance of 9.5mm from the case
2. Measured at 1.0 MHz and applied reverse voltage of 4.0V D.C.

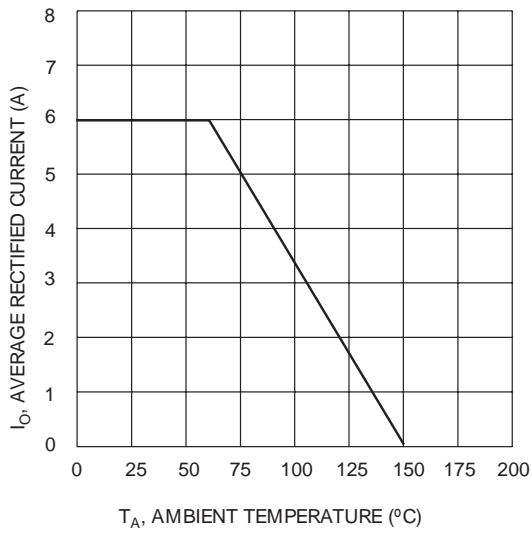

Fig. 1 Forward Current Derating Curve

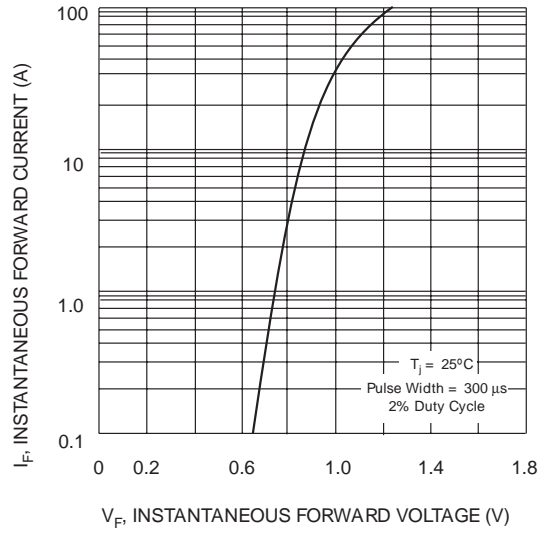

Fig. 2 Typical Forward Characteristics

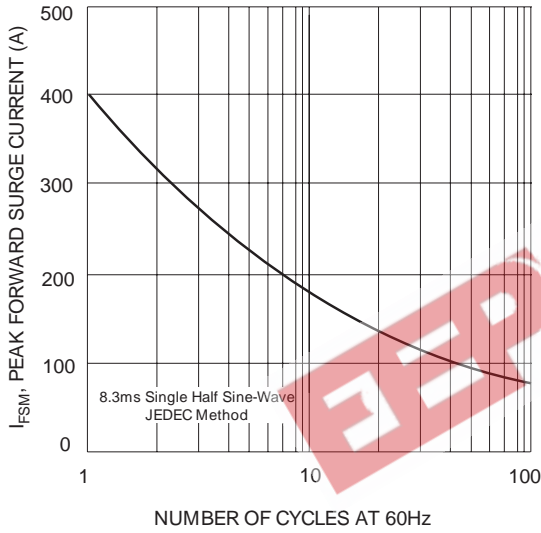

Fig. 3 Maximum Non-Repetitive Peak Forward Surge Current

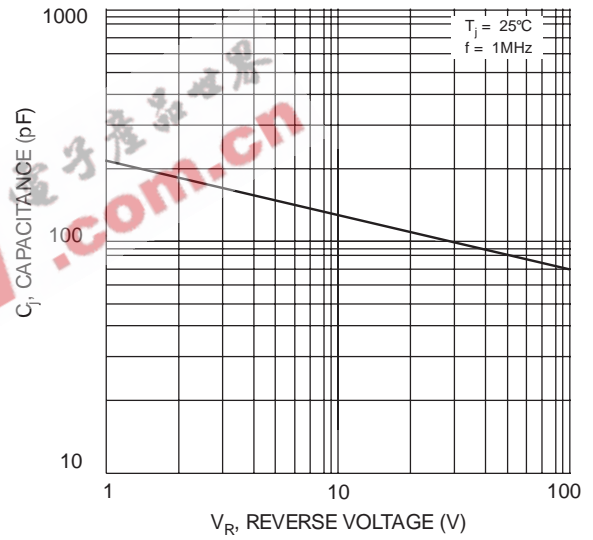
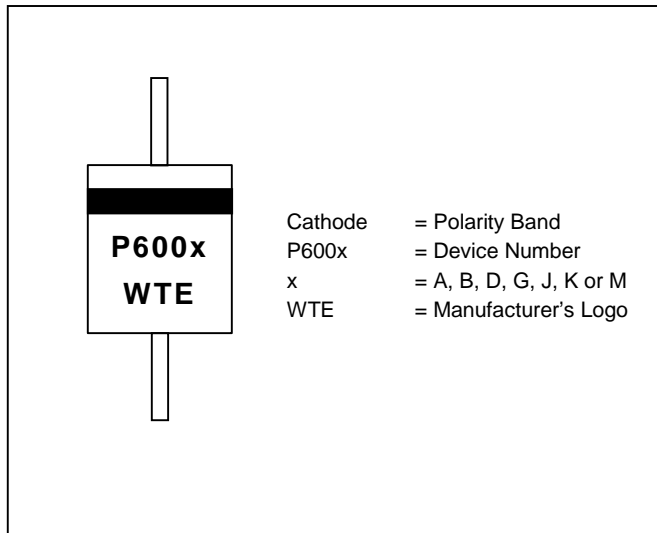
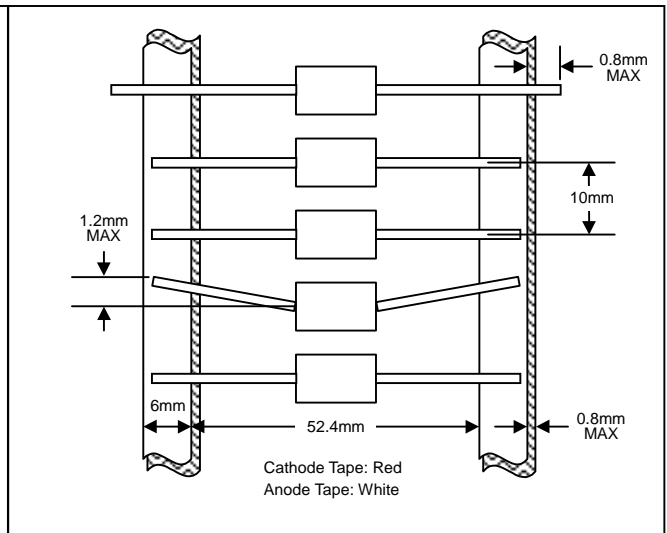

Fig. 4 Typical Junction Capacitance

MARKING INFORMATION



TAPING SPECIFICATIONS



PACKAGING INFORMATION

TAPE & REEL

330mm
 Product ID Label
 80±5mm

BULK

50mm
 210mm
 85mm

Packaging	Reel Diameter / Box Size (mm)	Quantity (PCS)	Carton Size (mm)	Quantity (PCS)	Approx. Gross Weight (KG)
TAPE & REEL	330	800	370 x 370 x 420	4,000	12.0
BULK	210 x 85 x 50	250	500 x 255 x 275	7,000	17.0

Note: 1. Paper reel, white or gray color. Core material: plastic or metal.
 2. Components are packed in accordance with EIA standard RS-296-E.

ORDERING INFORMATION

Product No.	Package Type	Shipping Quantity
P600A-T3	P-600	800/Tape & Reel
P600A	P-600	250 Units/Box
P600B-T3	P-600	800/Tape & Reel
P600B	P-600	250 Units/Box
P600D-T3	P-600	800/Tape & Reel
P600D	P-600	250 Units/Box
P600G-T3	P-600	800/Tape & Reel
P600G	P-600	250 Units/Box
P600J-T3	P-600	800/Tape & Reel
P600J	P-600	250 Units/Box
P600K-T3	P-600	800/Tape & Reel
P600K	P-600	250 Units/Box
P600M-T3	P-600	800/Tape & Reel
P600M	P-600	250 Units/Box

1. Products listed in **bold** are WTE **Preferred** devices.
2. Shipping quantity given is for minimum packing quantity only. For minimum order quantity, please consult the Sales Department.
3. **To order RoHS / Lead Free version (with Lead Free finish), add "-LF" suffix to part number above. For example, P600A-T3-LF.**

Won-Top Electronics Co., Ltd (WTE) has checked all information carefully and believes it to be correct and accurate. However, WTE cannot assume any responsibility for inaccuracies. Furthermore, this information does not give the purchaser of semiconductor devices any license under patent rights to manufacturer. WTE reserves the right to change any or all information herein without further notice.

WARNING: DO NOT USE IN LIFE SUPPORT EQUIPMENT. WTE power semiconductor products are not authorized for use as critical components in life support devices or systems without the express written approval.

Won-Top Electronics Co., Ltd.

No. 44 Yu Kang North 3rd Road, Chine Chen Dist., Kaohsiung, Taiwan

Phone: 886-7-822-5408 or 886-7-822-5410

Fax: 886-7-822-5417

Email: sales@wontop.com

Internet: http://www.wontop.com

We power your everyday.