

DATA SHEET

EEPW 电子產品世界
.com.cn

TDA1011

2 to 6 W audio power amplifier

Product specification
File under Integrated Circuits, IC01

November 1982

2 to 6 W audio power amplifier

TDA1011

The TDA1011 is a monolithic integrated audio amplifier circuit in a 9-lead single in-line (SIL) plastic package. The device is especially designed for portable radio and recorder applications and delivers up to 4 W in a 4 Ω load impedance. The device can deliver up to 6 W into 4 Ω at 16 V loaded supply in mains-fed applications. The maximum permissible supply voltage of 24 V makes this circuit very suitable for d.c. and a.c. apparatus, while the very low applicable supply voltage of 3,6 V permits 6 V applications. Special features are:

- single in-line (SIL) construction for easy mounting
- separated preamplifier and power amplifier
- high output power
- thermal protection
- high input impedance
- low current drain
- limited noise behaviour at radio frequencies

QUICK REFERENCE DATA

Supply voltage range	V_P		3,6 to 20 V
Peak output current	I_{OM}	max.	3 A
Output power at $d_{tot} = 10\%$			
$V_P = 16\text{ V}; R_L = 4\ \Omega$	P_o	typ.	6,5 W
$V_P = 12\text{ V}; R_L = 4\ \Omega$	P_o	typ.	4,2 W
$V_P = 9\text{ V}; R_L = 4\ \Omega$	P_o	typ.	2,3 W
$V_P = 6\text{ V}; R_L = 4\ \Omega$	P_o	typ.	1,0 W
Total harmonic distortion at $P_o = 1\text{ W}; R_L = 4\ \Omega$	d_{tot}	typ.	0,2 %
Input impedance			
preamplifier (pin 8)	$ Z_i $	>	100 k Ω
power amplifier (pin 6)	$ Z_i $	typ.	20 k Ω
Total quiescent current	I_{tot}	typ.	14 mA
Operating ambient temperature	T_{amb}		-25 to +150 $^{\circ}\text{C}$
Storage temperature	T_{stg}		-55 to +150 $^{\circ}\text{C}$

PACKAGE OUTLINE

9-lead SIL; plastic (SOT110B); SOT110-1; 1996 July 23.

2 to 6 W audio power amplifier

TDA1011

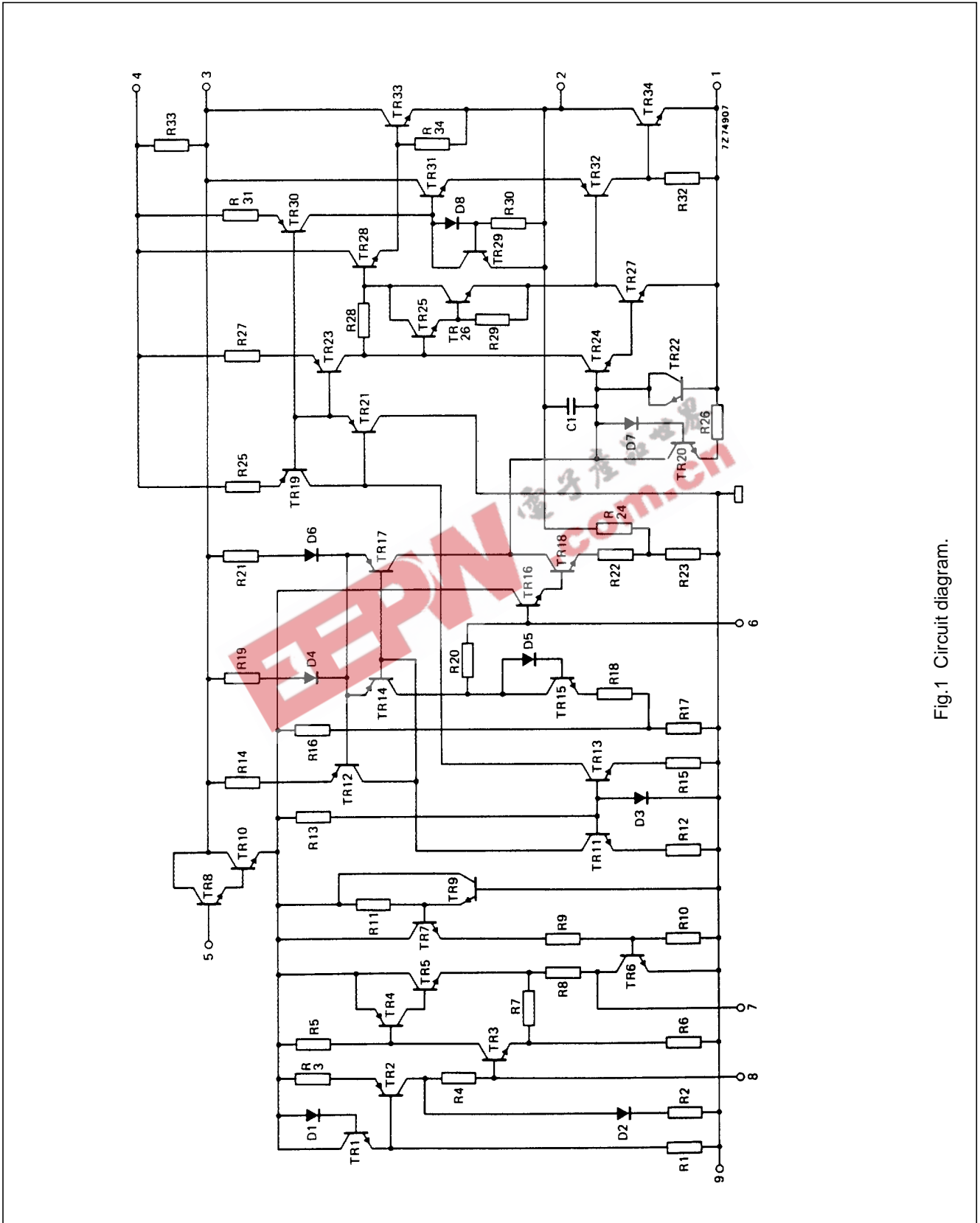

Fig.1 Circuit diagram.

2 to 6 W audio power amplifier

TDA1011

RATINGS

Limiting values in accordance with the Absolute Maximum System (IEC 134)

Supply voltage	V_P	max.	24 V
Peak output current	I_{OM}	max.	3 A
Total power dissipation	see derating curve Fig.2		
Storage temperature	T_{stg}	-55 to + 150 °C	
Operating ambient temperature	T_{amb}	-25 to + 150 °C	
A.C. short-circuit duration of load during sine-wave drive; $V_P = 12$ V	t_{sc}	max.	100 hours

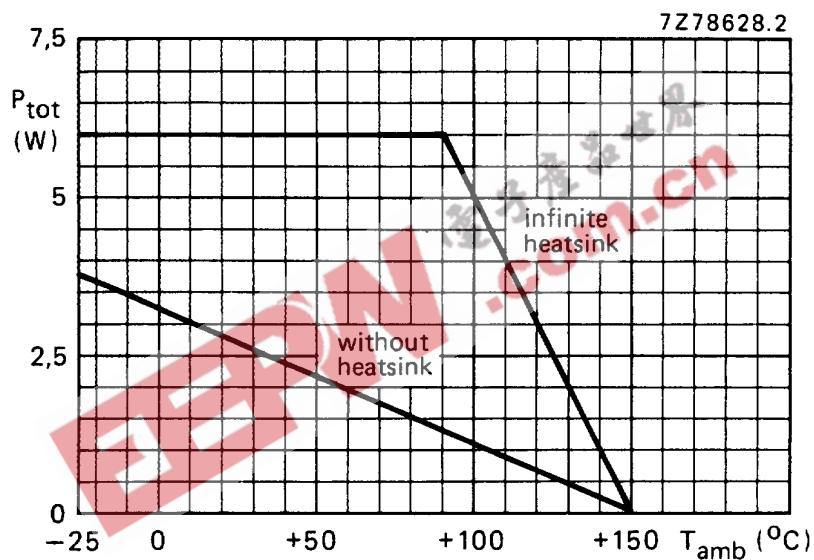

Fig.2 Power derating curve.

HEATSINK DESIGNAssume $V_P = 12$ V; $R_L = 4 \Omega$; $T_{amb} = 60$ °C maximum; $P_o = 3,8$ W.

The maximum sine-wave dissipation is 1,8 W.

The derating of 10 K/W of the package requires the following external heatsink (for sine-wave drive):

$$R_{th\ j-a} = R_{th\ j-tab} + R_{th\ tab-h} + R_{th\ h-a} = \frac{150 - 60}{1,8} = 50 \text{ K/W.}$$

Since $R_{th\ j-tab} = 10$ K/W and $R_{th\ tab-h} = 1$ K/W, $R_{th\ h-a} = 50 - (10 + 1) = 39$ K/W.

2 to 6 W audio power amplifier

TDA1011

D.C. CHARACTERISTICS

Supply voltage range	V_P	3,6 to 20 V
Repetitive peak output current	I_{ORM}	< 2 A
Total quiescent current at $V_P = 12$ V	I_{tot}	typ. 14 mA
		< 22 mA

A.C. CHARACTERISTICS

$T_{amb} = 25$ °C; $V_P = 12$ V; $R_L = 4$ Ω ; $f = 1$ kHz unless otherwise specified; see also Fig.3.

A.F. output power at $d_{tot} = 10\%$ (note 1)

with bootstrap:

$V_P = 16$ V; $R_L = 4$ Ω

P_o typ. 6,5 W

$V_P = 12$ V; $R_L = 4$ Ω

P_o > 3,6 W
typ. 4,2 W

$V_P = 9$ V; $R_L = 4$ Ω

P_o typ. 2,3 W

$V_P = 6$ V; $R_L = 4$ Ω

P_o typ. 1,0 W

without bootstrap:

$V_P = 12$ V; $R_L = 4$ Ω

P_o typ. 3,0 W

Voltage gain:

preamplifier (note 2)

G_{v1} typ. 23 dB
21 to 25 dB

power amplifier

G_{v2} typ. 29 dB
27 to 31 dB

total amplifier

$G_{v\ tot}$ typ. 52 dB
50 to 54 dB

Total harmonic distortion at $P_o = 1,5$ W

d_{tot} typ. 0,3 %
< 1 %

Frequency response; -3 dB (note 3)

B 60 Hz to 15 kHz

Input impedance:

preamplifier (note 4)

$|Z_{i1}|$ > 100 k Ω
typ. 200 k Ω

power amplifier

$|Z_{i2}|$ typ. 20 k Ω

Output impedance preamplifier

$|Z_{o1}|$ typ. 1 k Ω

Output voltage preamplifier (r.m.s. value)

$d_{tot} < 1\%$ (note 2)

$V_{o(rms)}$ > 0,7 V

Noise output voltage (r.m.s. value; note 5)

$R_S = 0$ Ω

$V_{n(rms)}$ typ. 0,2 mV

$R_S = 10$ k Ω

$V_{n(rms)}$ typ. 0,6 mV
< 1,4 mV

Noise output voltage at $f = 500$ kHz (r.m.s. value)

B = 5 kHz; $R_S = 0$ Ω

$V_{n(rms)}$ typ. 8 μ V

2 to 6 W audio power amplifier

TDA1011

Ripple rejection (note 6)

$f = 1$ to 10 kHz

$f = 100$ Hz; $C_2 = 1 \mu\text{F}$

RR typ. 42 dB

RR > 35 dB

Bootstrap current at onset of clipping; pin 4 (r.m.s. value)

$I_{4(\text{rms})}$ typ. 35 mA

Notes

1. Measured with an ideal coupling capacitor to the speaker load.
2. Measured with a load resistor of $20 \text{ k}\Omega$.
3. Measured at $P_o = 1 \text{ W}$; the frequency response is mainly determined by C_1 and C_3 for the low frequencies and by C_4 for the high frequencies.
4. Independent of load impedance of preamplifier.
5. Unweighted r.m.s. noise voltage measured at a bandwidth of 60 Hz to 15 kHz (12 dB/octave).
6. Ripple rejection measured with a source impedance between 0 and $2 \text{ k}\Omega$ (maximum ripple amplitude: 2 V).
7. The tab must be electrically floating or connected to the substrate (pin 9).

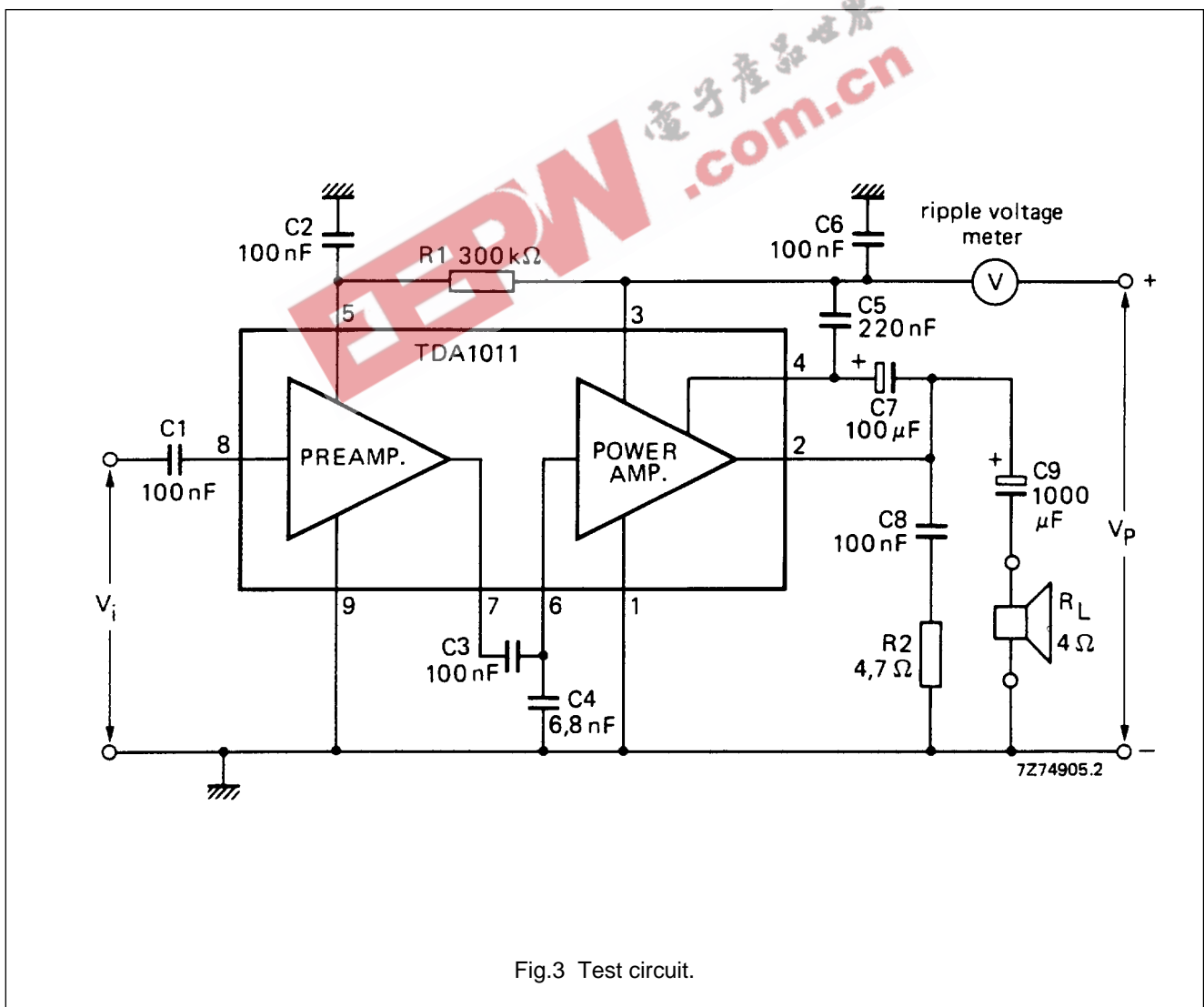
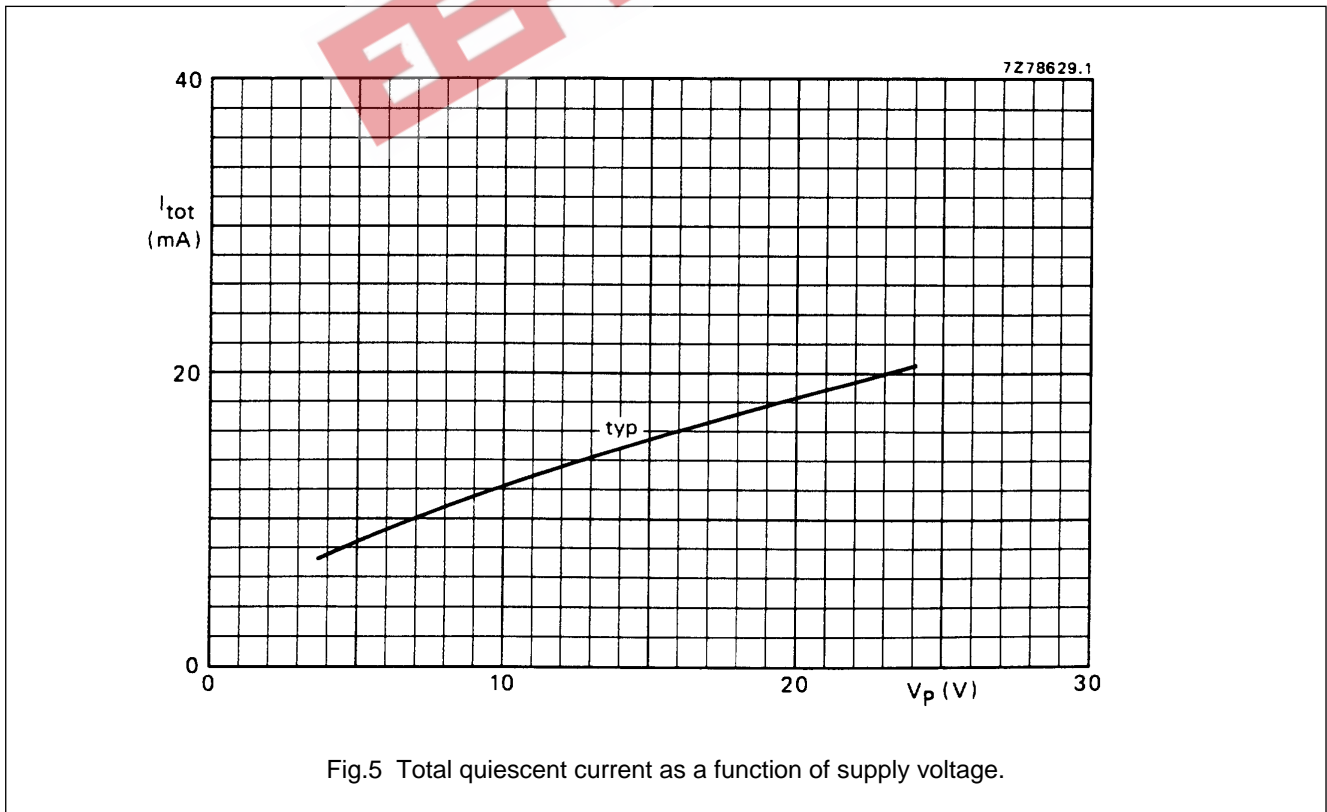
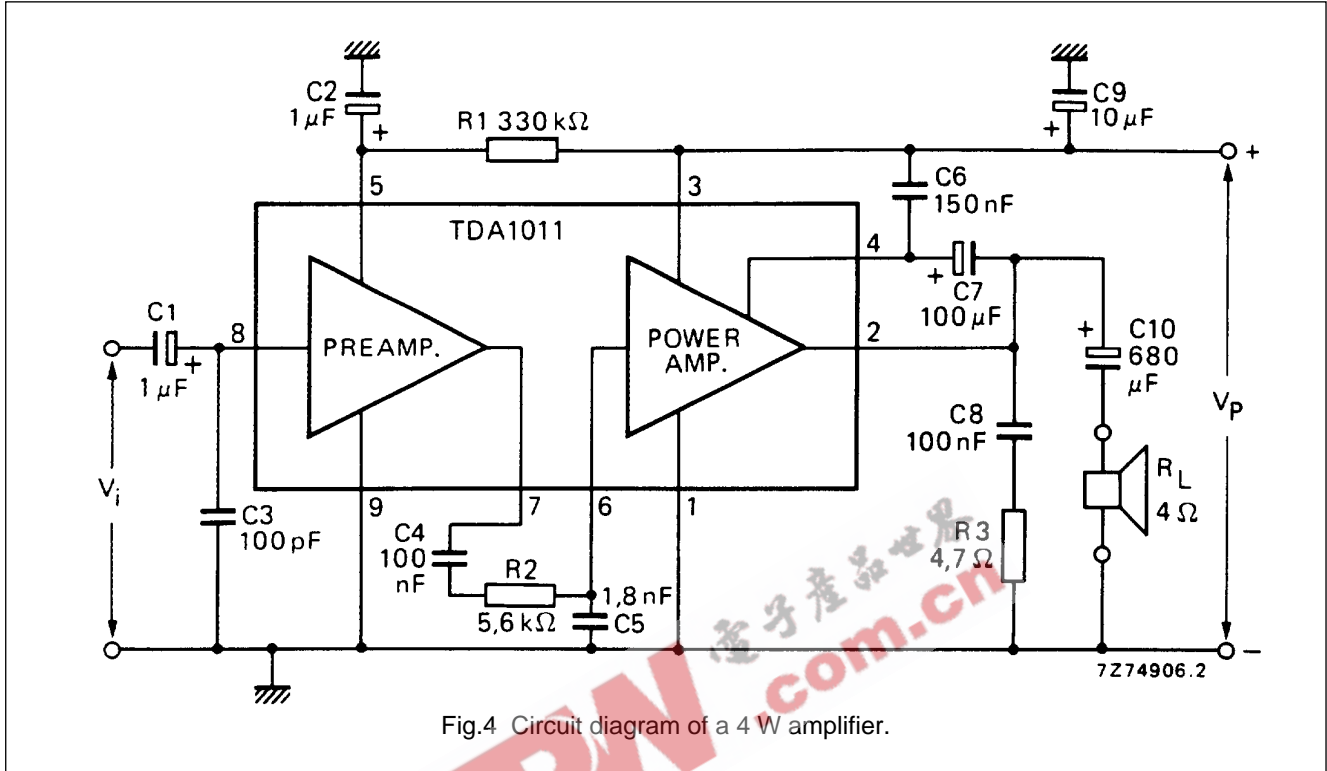

Fig.3 Test circuit.

2 to 6 W audio power amplifier

TDA1011

APPLICATION INFORMATION



2 to 6 W audio power amplifier

TDA1011

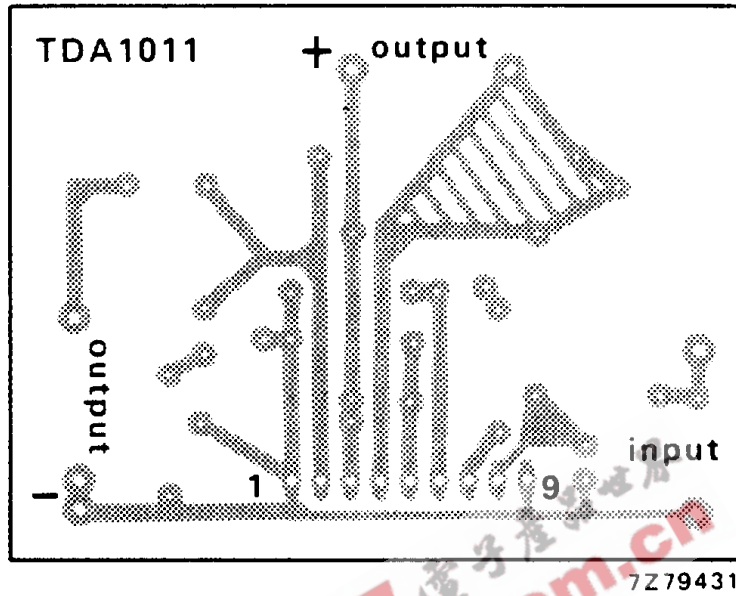

Fig.6 Track side of printed-circuit board used for the circuit of Fig.4; p.c. board dimensions 62 mm x 48 mm.

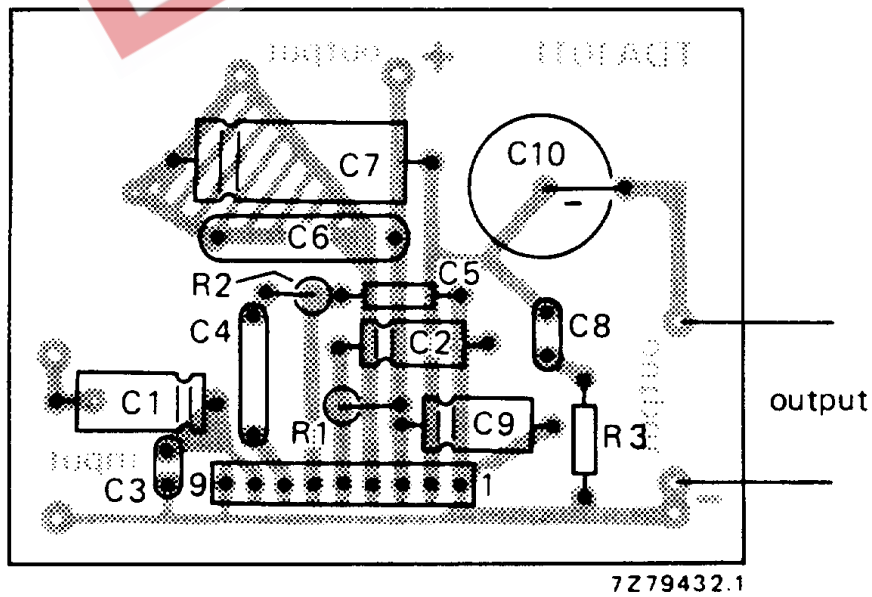

Fig.7 Component side of printed-circuit board showing component layout used for the circuit of Fig.4.

2 to 6 W audio power amplifier

TDA1011

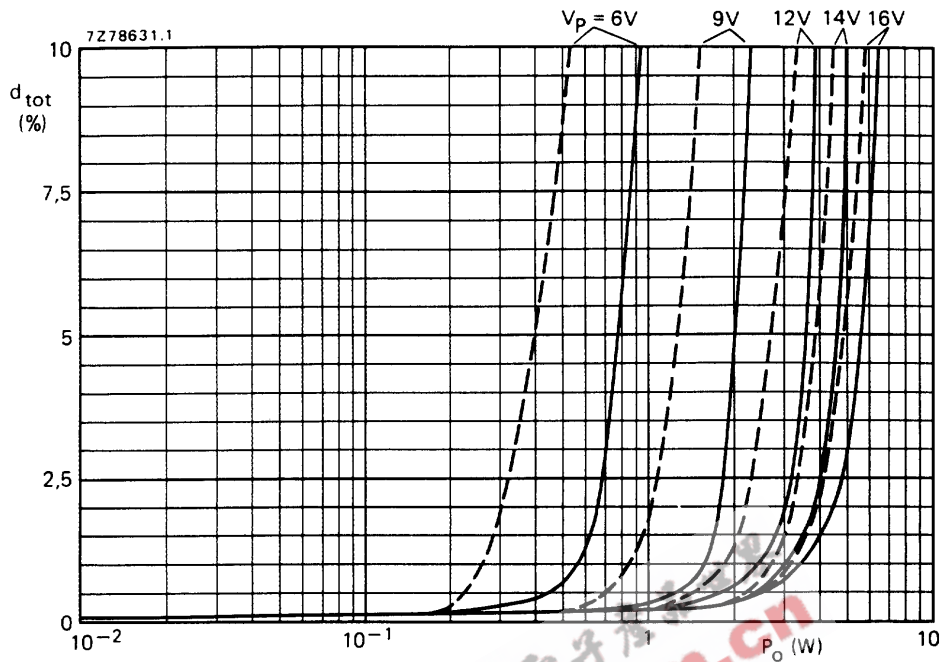

Fig.8 Total harmonic distortion as a function of output power across R_L ; — with bootstrap; --- without bootstrap; $f = 1$ kHz; typical values. The available output power is 5% higher when measured at pin 2 (due to series resistance of C10).

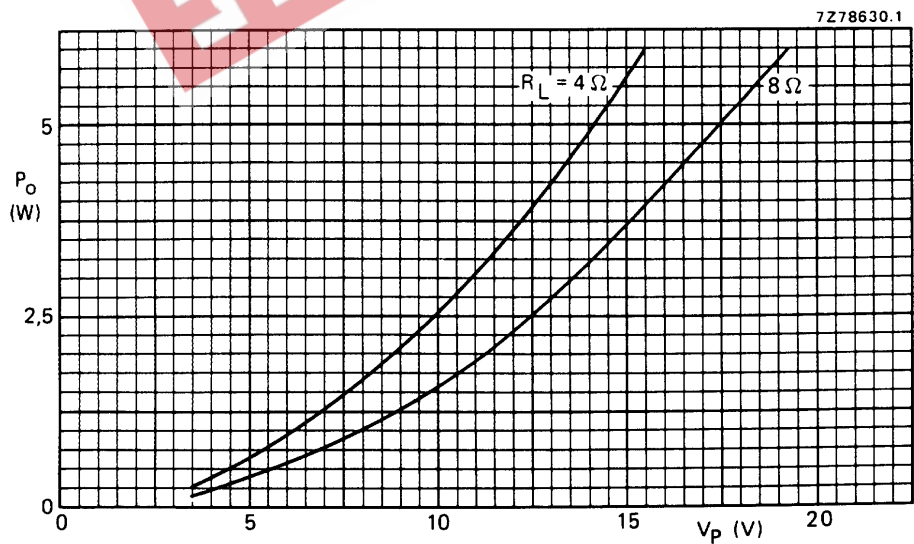

Fig.9 Output power across R_L as a function of supply voltage with bootstrap; $d_{tot} = 10\%$; typical values. The available output power is 5% higher when measured at pin 2 (due to series resistance of C10).

2 to 6 W audio power amplifier

TDA1011

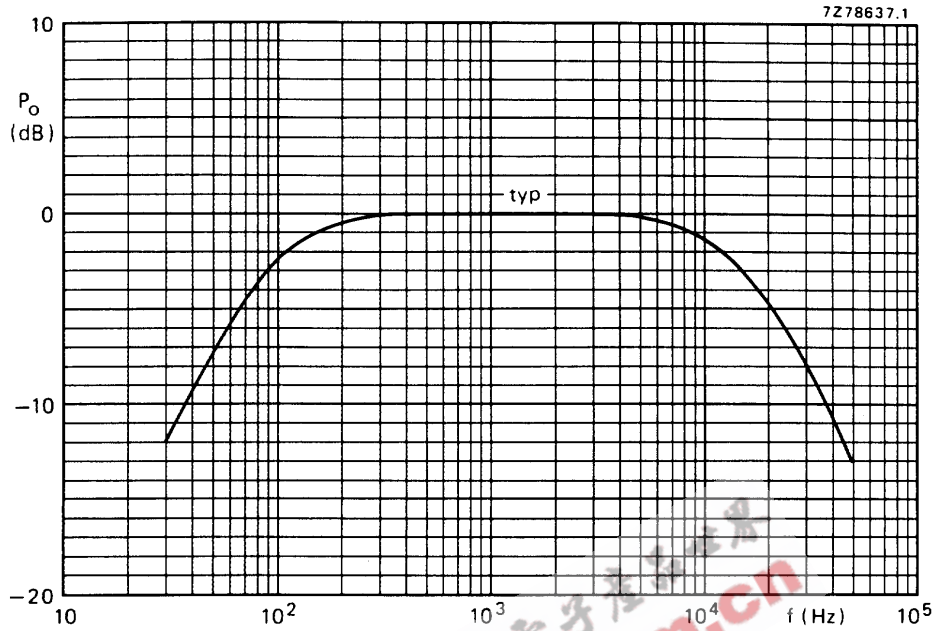

Fig.10 Voltage gain as a function of frequency; P_o relative to 0 dB = 1 W; $V_p = 12$ V; $R_L = 4 \Omega$.

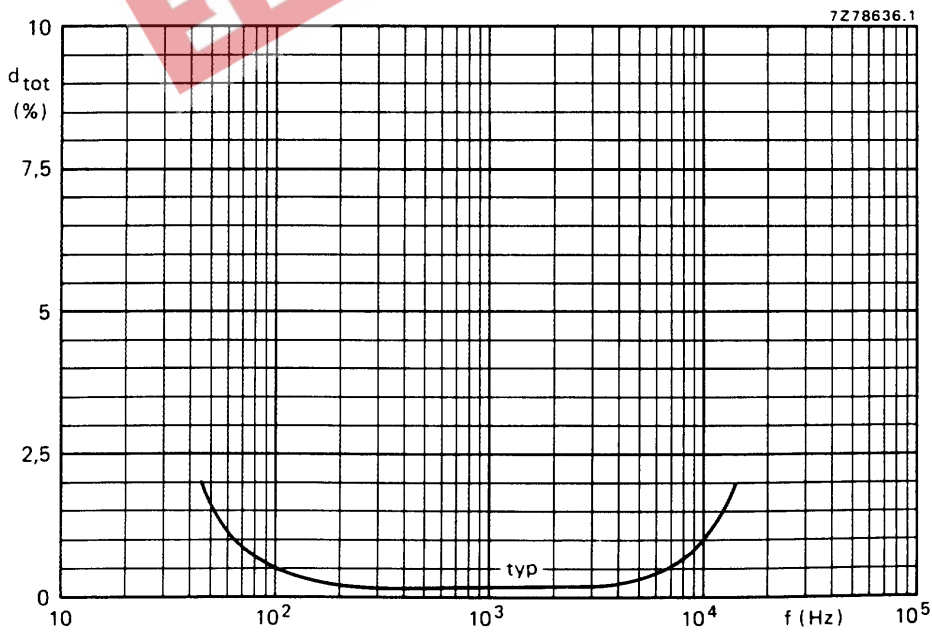

Fig.11 Total harmonic distortion as a function of frequency; $P_o = 1$ W; $V_p = 12$ V; $R_L = 4 \Omega$.

2 to 6 W audio power amplifier

TDA1011

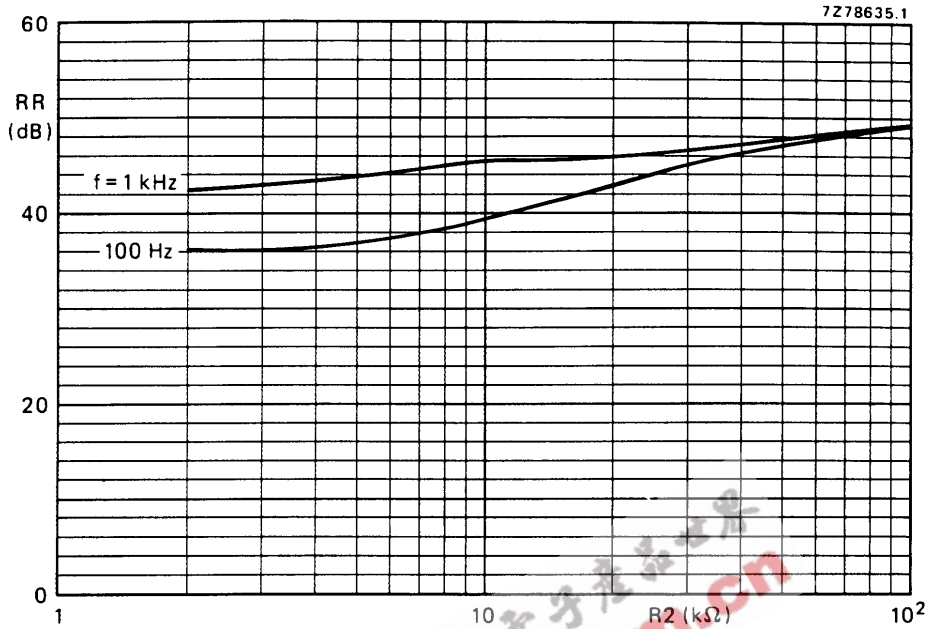

Fig.12 Ripple rejection as a function of R2 (see Fig.4); $R_S = 0$; typical values.

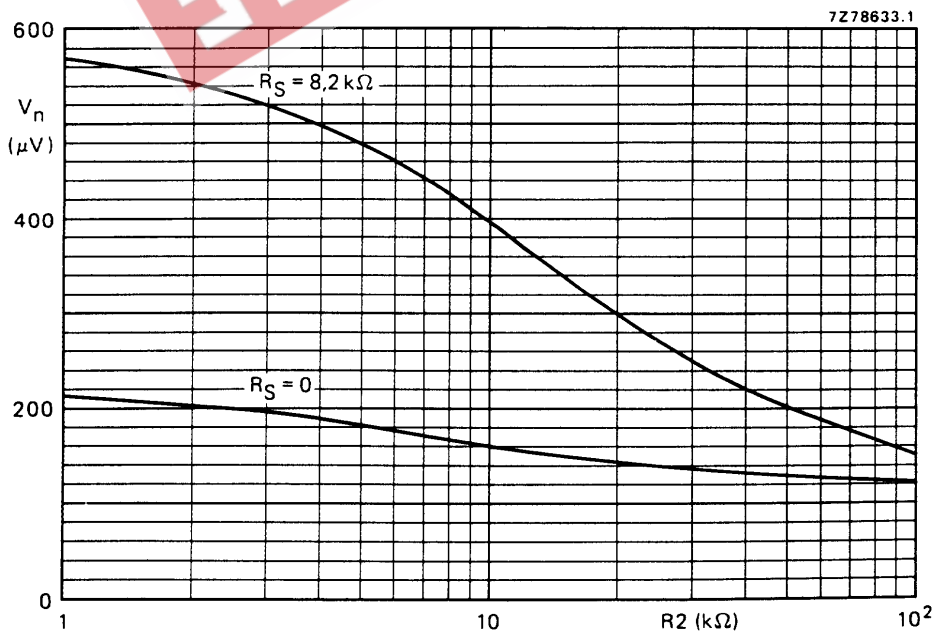

Fig.13 Noise output voltage as a function of R2 (see Fig.4); measured according to A-curve; capacitor C5 is adapted for obtaining a constant bandwidth.

2 to 6 W audio power amplifier

TDA1011

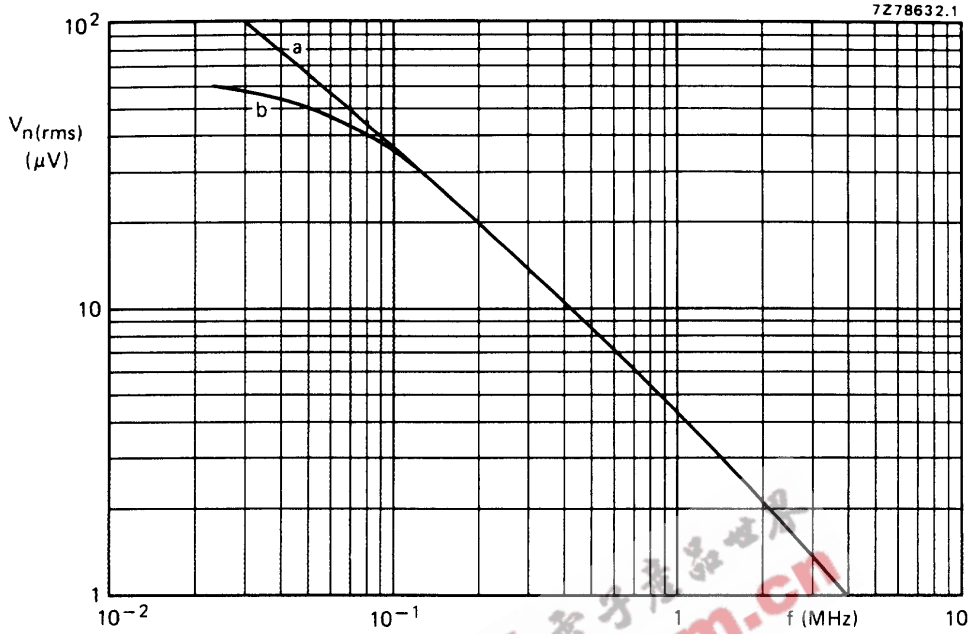

Fig.14 Noise output voltage as a function of frequency; curve a: total amplifier; curve b: power amplifier; $B = 5$ kHz; $R_S = 0$; typical values.

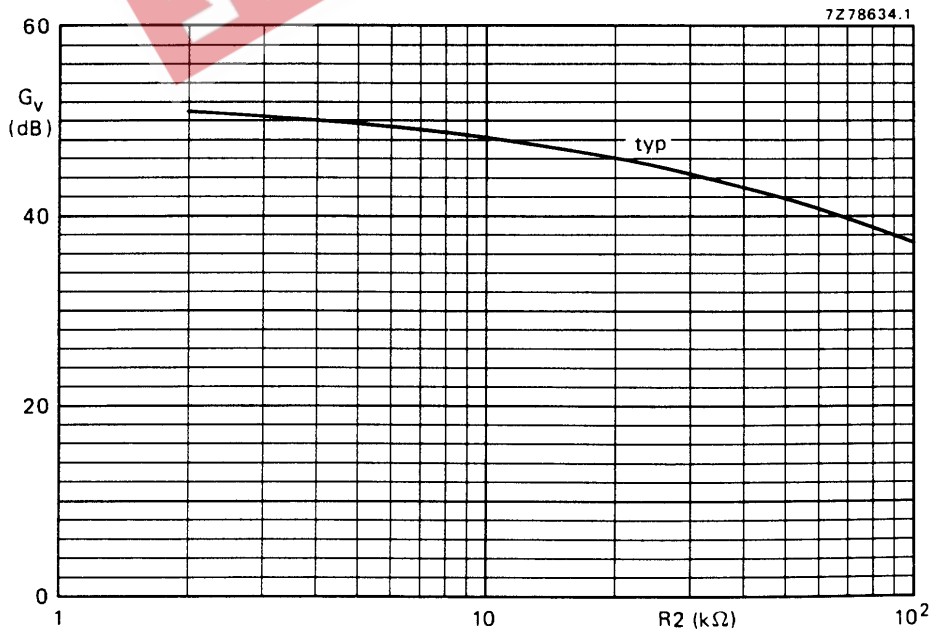

Fig.15 Voltage gain as a function of R_2 (see Fig.4).

2 to 6 W audio power amplifier

TDA1011

PACKAGE OUTLINE

SIL9MPF: plastic single in-line medium power package with fin; 9 leads

SOT110-1

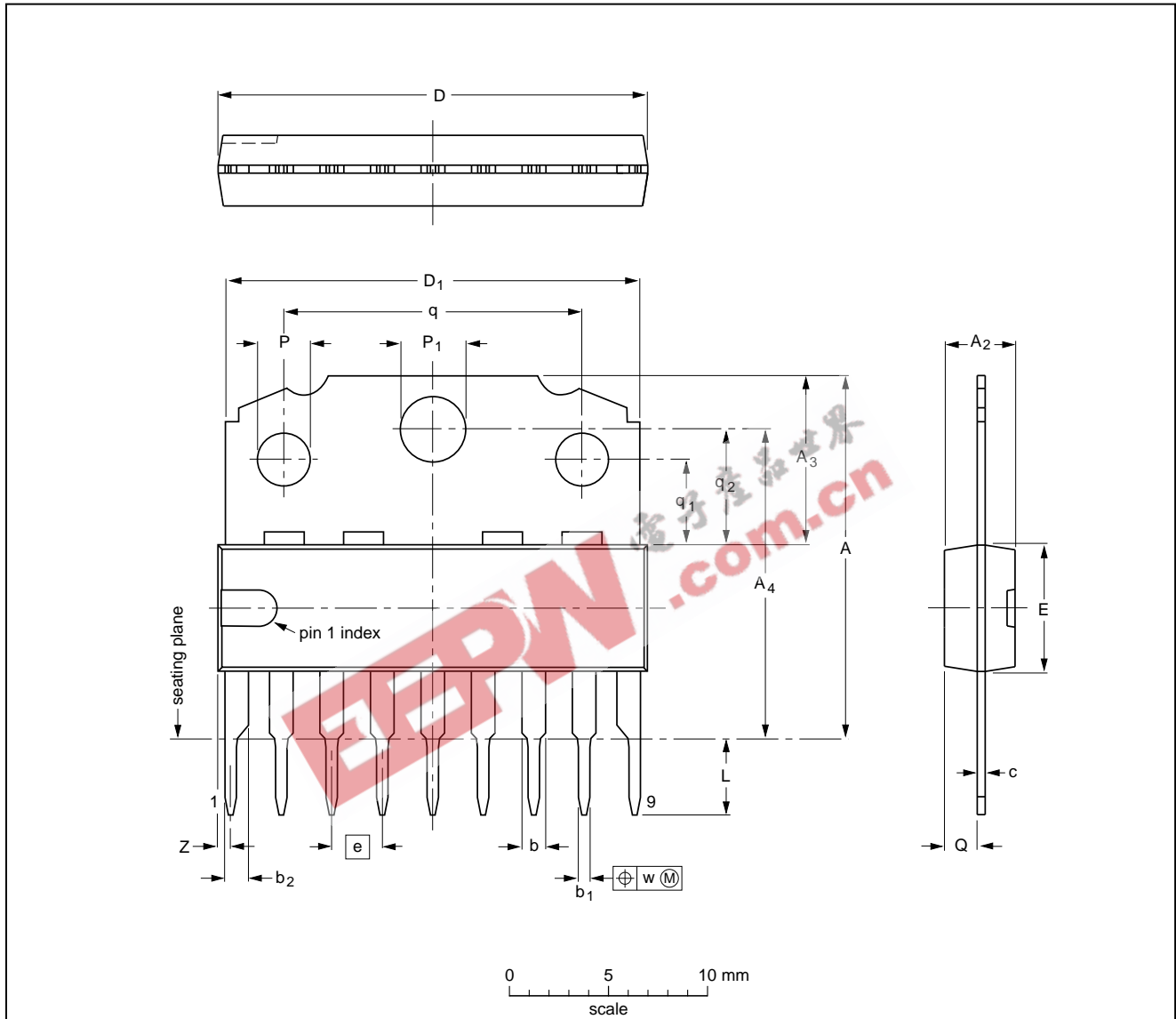

DIMENSIONS (mm are the original dimensions)

UNIT	A	A ₂ max.	A ₃	A ₄	b	b ₁	b ₂	c	D ⁽¹⁾	D ₁	E ⁽¹⁾	e	L	P	P ₁	Q	q	q ₁	q ₂	w	Z ⁽¹⁾ max.
mm	18.5 17.8	3.7	8.7 8.0	15.8 15.4	1.40 1.14	0.67 0.50	1.40 1.14	0.48 0.38	21.8 21.4	21.4 20.7	6.48 6.20	2.54	3.9 3.4	2.75 2.50	3.4 3.2	1.75 1.55	15.1 14.9	4.4 4.2	5.9 5.7	0.25	1.0

Note

1. Plastic or metal protrusions of 0.25 mm maximum per side are not included.

OUTLINE VERSION	REFERENCES				EUROPEAN PROJECTION	ISSUE DATE
	IEC	JEDEC	EIAJ			
SOT110-1						92-11-17 95-02-25

2 to 6 W audio power amplifier

TDA1011

SOLDERING

Introduction

There is no soldering method that is ideal for all IC packages. Wave soldering is often preferred when through-hole and surface mounted components are mixed on one printed-circuit board. However, wave soldering is not always suitable for surface mounted ICs, or for printed-circuits with high population densities. In these situations reflow soldering is often used.

This text gives a very brief insight to a complex technology. A more in-depth account of soldering ICs can be found in our "IC Package Databook" (order code 9398 652 90011).

Soldering by dipping or by wave

The maximum permissible temperature of the solder is 260 °C; solder at this temperature must not be in contact with the joint for more than 5 seconds. The total contact time of successive solder waves must not exceed 5 seconds.

The device may be mounted up to the seating plane, but the temperature of the plastic body must not exceed the specified maximum storage temperature ($T_{stg\ max}$). If the printed-circuit board has been pre-heated, forced cooling may be necessary immediately after soldering to keep the temperature within the permissible limit.

Repairing soldered joints

Apply a low voltage soldering iron (less than 24 V) to the lead(s) of the package, below the seating plane or not more than 2 mm above it. If the temperature of the soldering iron bit is less than 300 °C it may remain in contact for up to 10 seconds. If the bit temperature is between 300 and 400 °C, contact may be up to 5 seconds.

DEFINITIONS

Data sheet status	
Objective specification	This data sheet contains target or goal specifications for product development.
Preliminary specification	This data sheet contains preliminary data; supplementary data may be published later.
Product specification	This data sheet contains final product specifications.
Limiting values	
Limiting values given are in accordance with the Absolute Maximum Rating System (IEC 134). Stress above one or more of the limiting values may cause permanent damage to the device. These are stress ratings only and operation of the device at these or at any other conditions above those given in the Characteristics sections of the specification is not implied. Exposure to limiting values for extended periods may affect device reliability.	
Application information	
Where application information is given, it is advisory and does not form part of the specification.	

LIFE SUPPORT APPLICATIONS

These products are not designed for use in life support appliances, devices, or systems where malfunction of these products can reasonably be expected to result in personal injury. Philips customers using or selling these products for use in such applications do so at their own risk and agree to fully indemnify Philips for any damages resulting from such improper use or sale.