

### STANDARD RECOVERY DIODES

Stud Version

#### Features

- High surge current capability
- Designed for a wide range of applications
- Stud cathode and stud anode version
- Leaded version available
- Types up to 1600V  $V_{RRM}$

70 A

#### Typical Applications

- Battery charges
- Converters
- Power supplies
- Machine tool controls

#### Major Ratings and Characteristics

Parameters	70HF(R)		Units
	10 to 120	140 to 160	
$I_{F(AV)}$	70	70	A
@ $T_C$	140	110	°C
$I_{F(RMS)}$	110		A
$I_{FSM}$ @ 50Hz	1200		A
@ 60Hz	1250		A
$I^2t$ @ 50Hz	7100		A <sup>2</sup> s
@ 60Hz	6450		A <sup>2</sup> s
$V_{RRM}$ range	100 to 1200	1400 to 1600	V
$T_J$ range	- 65 to 180	- 65 to 150	°C



## 70HF(R) Series

Bulletin I20202 rev. E 03/04

International  
IR Rectifier

### ELECTRICAL SPECIFICATIONS

#### Voltage Ratings

Type number	Voltage Code	$V_{RRM}$ , maximum repetitive peak reverse voltage V	$V_{RSM}$ , maximum non-repetitive peak reverse voltage V	$V_{R(BR)}$ , minimum avalanche voltage V	$I_{RRM}$ max. @ $T_J = T_{J \text{ max.}}$ mA
70HF(R)	10	100	200	200	15
	20	200	300	300	
	40	400	500	500	
	60	600	720	725	9
	80	800	960	950	
	100	1000	1200	1150	
	120	1200	1440	1350	
	140	1400	1650	1550	4.5
160	1600	1900	1750		

#### Forward Conduction

Parameter	70HF(R)		Units	Conditions	
	10 to 120	140 to 160			
$I_{F(AV)}$ Max. average forward current @ Case temperature	70	70	A	180° conduction, half sine wave	
	140	110	°C		
$I_{F(RMS)}$ Max. RMS forward current	110		A		
$I_{FSM}$ Max. peak, one-cycle forward, non-repetitive surge current	1200		A	t = 10ms	No voltage reappplied
	1250			t = 8.3ms	
	1000			t = 10ms	100% $V_{RRM}$ reappplied
	1050			t = 8.3ms	
$I^2t$ Maximum $I^2t$ for fusing	7100		A <sup>2</sup> s	t = 10ms	No voltage reappplied
	6450			t = 8.3ms	
	5000			t = 10ms	100% $V_{RRM}$ reappplied
	4550			t = 8.3ms	
$I^2/t$ Maximum $I^2/t$ for fusing	71000		A <sup>2</sup> /s	t = 0.1 to 10ms, no voltage reappplied	
	$V_{F(TO)1}$ Low level value of threshold voltage	0.79		V	$(16.7\% \times \pi \times I_{F(AV)} < I < \pi \times I_{F(AV)})$ , $T_J = T_{J \text{ max.}}$
$V_{F(TO)2}$ High level value of threshold voltage	1.00		$(I > \pi \times I_{F(AV)})$ , $T_J = T_{J \text{ max.}}$		
$r_{f1}$ Low level value of forward slope resistance	2.33		mΩ	$(16.7\% \times \pi \times I_{F(AV)} < I < \pi \times I_{F(AV)})$ , $T_J = T_{J \text{ max.}}$	
	$r_{f2}$ High level value of forward slope resistance	1.53		$(I > \pi \times I_{F(AV)})$ , $T_J = T_{J \text{ max.}}$	
$V_{FM}$ Max. forward voltage drop	1.35	1.46	V	$I_{pk} = 220A$ , $T_J = 25^\circ C$ , $t_p = 400\mu s$ rectangular wave	

Thermal and Mechanical Specifications

Parameter	70HF(R)		Units	Conditions
	10 to 120	140 to 160		
T <sub>J</sub> Max. junction operating temperature range	-65 to 180	-65 to 150	°C	
T <sub>stg</sub> Max. storage temperature range	-65 to 180	-65 to 150		
R <sub>thJC</sub> Max. thermal resistance, junction to case	0.45		K/W	DC operation
R <sub>thCS</sub> Max. thermal resistance, case to heatsink	0.25			Mounting surface, smooth, flat and greased
T Max. allowed mounting torque ±10%	2.3 - 3.4		Nm	Not lubricated threads
	20 - 30		lbf·in	
wt Approximate weight	17 (0.6)		g (oz)	
Case style	DO-203AB (DO5)			See Outline Table

$\Delta R_{thJC}$  Conduction

(The following table shows the increment of thermal resistance R<sub>thJC</sub> when devices operate at different conduction angles than DC)

Conduction angle	Sinusoidal conduction	Rectangular conduction	Units	Conditions
180°	0.08	0.06	K/W	T <sub>J</sub> = T <sub>J</sub> max.
120°	0.10	0.11		
90°	0.13	0.14		
60°	0.19	0.20		
30°	0.30	0.30		

Ordering Information Table

Device Code

70	HF	R	160	M
----	----	---	-----	---

(1) (2) (3) (4) (5)

- 1** - 70 = Standard device  
71 = Not isolated lead  
72 = Isolated lead with silicone sleeve  
(Red = Reverse polarity)  
(Blue = Normal polarity)
- 2** - HF = Standard diode
- 3** - None = Stud Normal Polarity (Cathode to Stud)  
R = Stud Reverse Polarity (Anode to Stud)
- 4** - Voltage code: Code x 10 = V<sub>RRM</sub> (See Voltage Ratings table)
- 5** - None = Stud base DO-203AB (DO-5) 1/4" 28UNF-2A  
M = Stud base DO-203AB (DO-5) M6 X 1

**70HF(R) Series**

Bulletin I20202 rev. E 03/04

Outlines Table

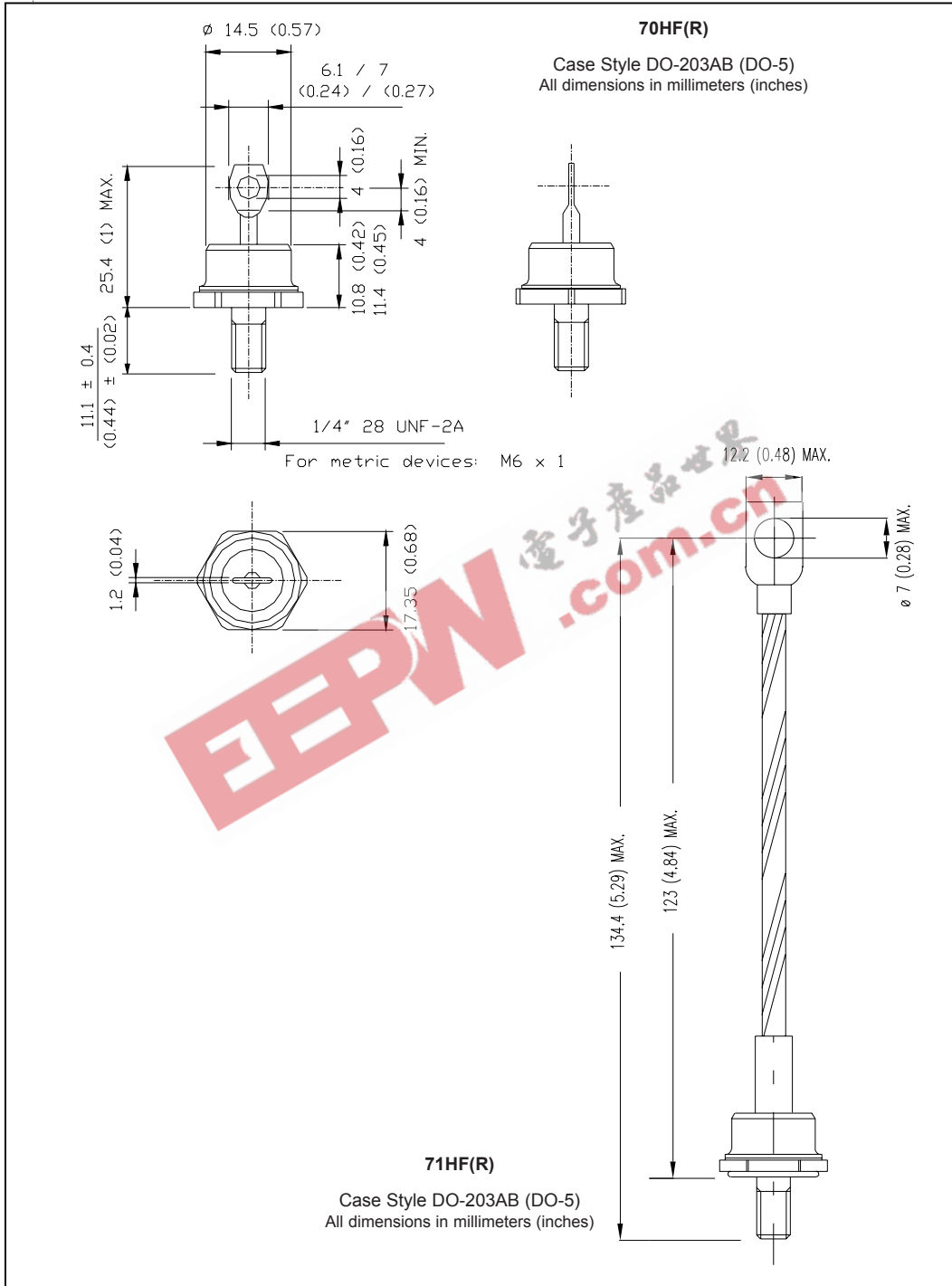

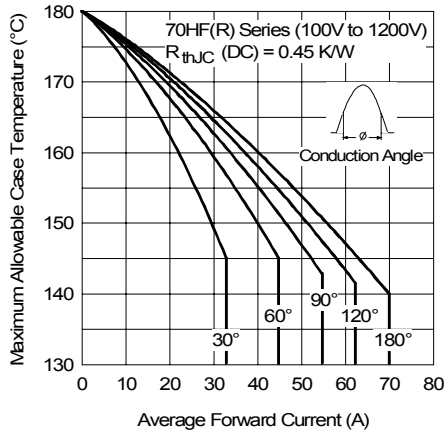

Fig. 1 - Current Ratings Characteristics

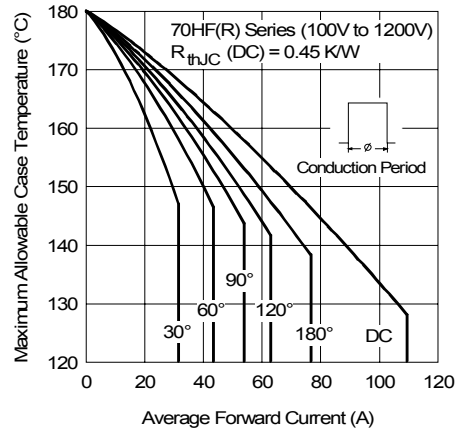

Fig. 2 - Current Ratings Characteristics

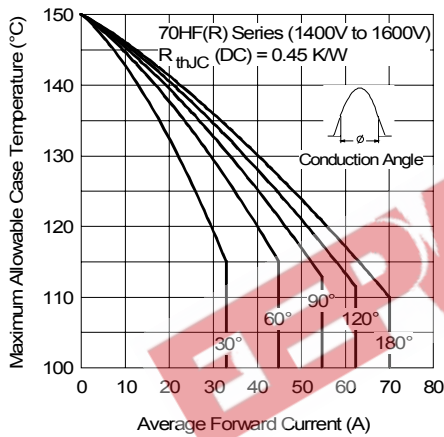

Fig. 3 - Current Ratings Characteristics

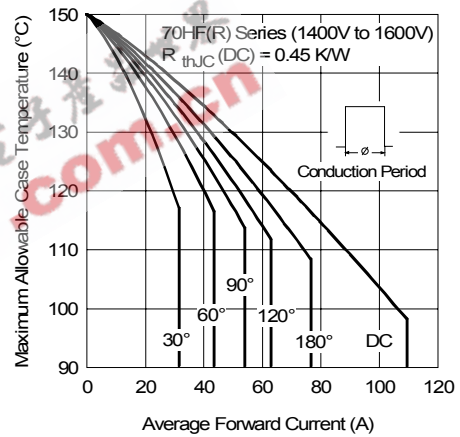

Fig. 4 - Current Ratings Characteristics

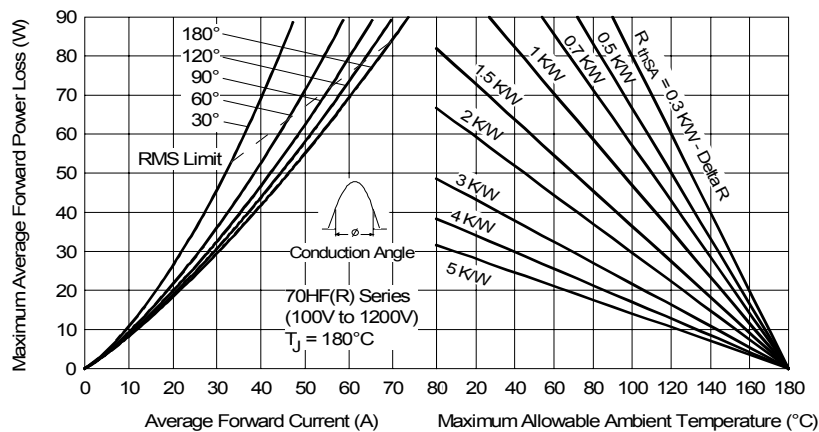

Fig. 5 - Forward Power Loss Characteristics

# 70HF(R) Series

Bulletin I20202 rev. E 03/04

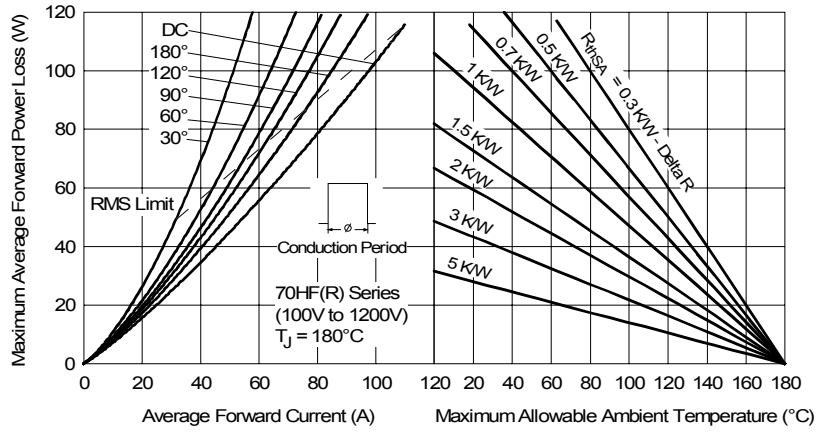

Fig. 6 - Forward Power Loss Characteristics

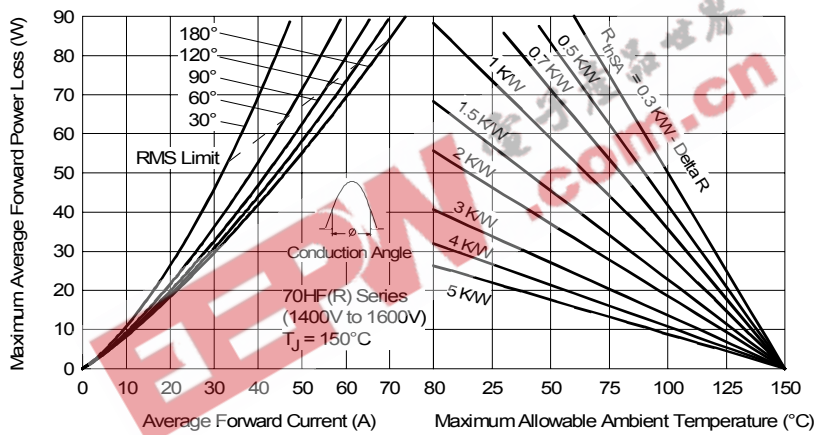

Fig. 7 - Forward Power Loss Characteristics

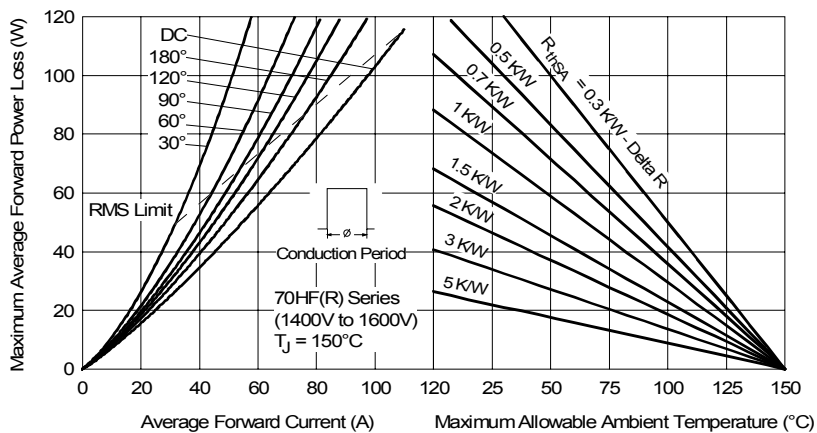

Fig. 8 - Forward Power Loss Characteristics

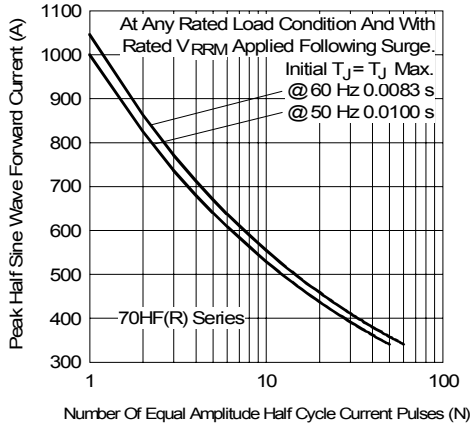

Fig. 9 - Maximum Non-Repetitive Surge Current

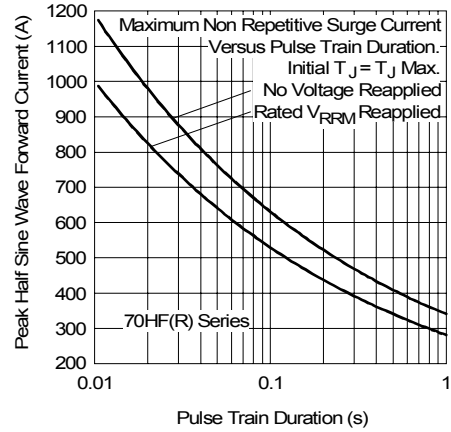

Fig. 10 - Maximum Non-Repetitive Surge Current

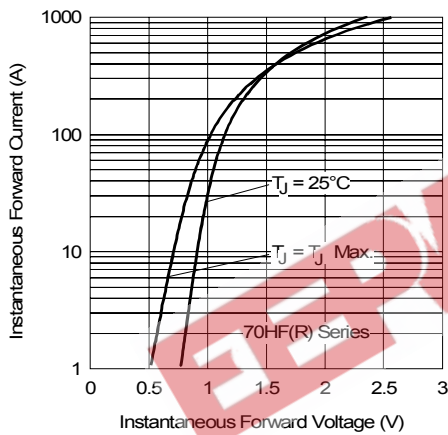

Fig. 11 - Forward Voltage Drop Characteristics

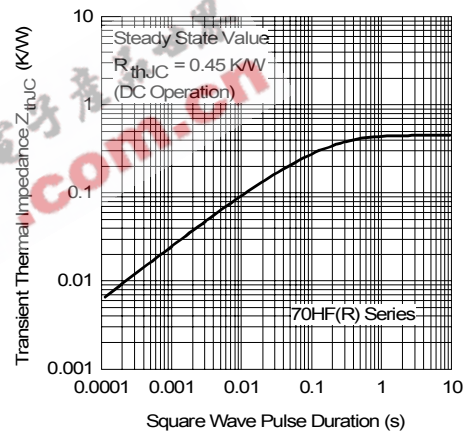

Fig. 12 - Thermal Impedance  $Z_{thjC}$  Characteristics

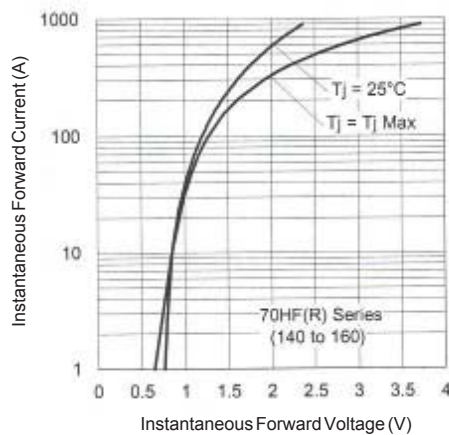

Fig. 13 - Forward Voltage Drop Characteristics

## 70HF(R) Series

Bulletin I20202 rev. E 03/04

International  
**IR** Rectifier

EEPW 电子产品世界  
.com.cn

Data and specifications subject to change without notice.  
This product has been designed and qualified for Industrial Level.  
Qualification Standards can be found on IR's Web site.

International  
**IR** Rectifier

**IR WORLD HEADQUARTERS:** 233 Kansas St., El Segundo, California 90245, USA Tel: (310) 252-7105  
TAC Fax: (310) 252-7309  
Visit us at [www.irf.com](http://www.irf.com) for sales contact information. 03/04