

International
IR Rectifier

QUIETIR Series
70EPF..

**FAST SOFT RECOVERY
RECTIFIER DIODE**



$$V_F < 1.33V @ 70A$$

$$t_{rr} = 70ns$$

$$V_{RRM} 200/600V$$

Major Ratings and Characteristics

Characteristics	70EPF..	Units
$I_{F(AV)}$ 180° Sin. Conduction @ $T_C = 97^\circ C$	70	A
V_{RRM} range	200/600	V
$I_{F(RMS)}$	135	A
V_F @ 70A, $T_J = 25^\circ C$	1.33	V
t_{rr} @ 1A, -100A/ μs	70	ns
T_J range	-40 to 150	$^\circ C$

Description/Features

The 70EPF.. fast soft recovery **QUIETIR** rectifier series has been optimized for combined short reverse recovery time and low forward voltage drop.

The glass passivation ensures stable reliable operation in the most severe temperature and power cycling conditions.

Available in the new **PowIRtab™** package, this new series is suitable for a large range of applications combining excellent die to footprint ratio and sturdiness connectivity for use in high current environments.

Typical applications are both:

- Output rectification and freewheeling in inverters, choppers and converters
- Input rectifications where severe restrictions on conducted EMI should be met.

Case Styles

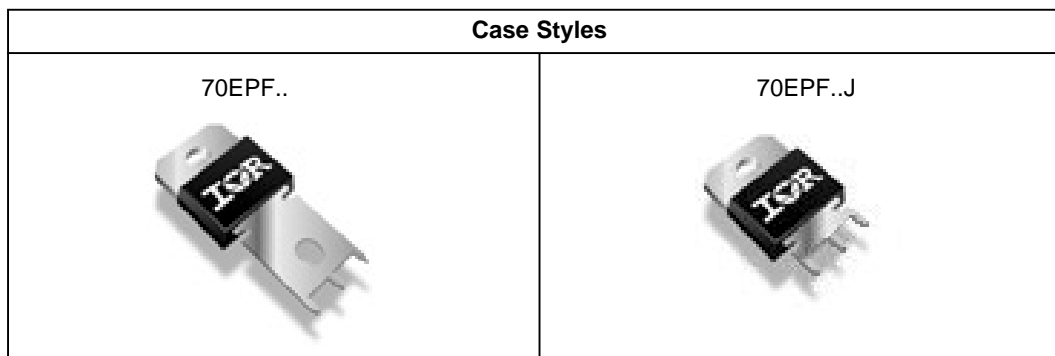

(*) for higher voltage up to 1600V contact factory

Voltage Ratings

Part Number	V_{RRM} , maximum peak reverse voltage V	V_{RSM} , maximum non repetitive peak reverse voltage V	I_{RRM} 150°C mA
70EPF02	200	300	13
70EPF04	400	500	
70EPF06	600	700	

Absolute Maximum Ratings

Parameters	70EPF..	Units	Conditions
$I_{F(AV)}$ Max. Average Forward Current	70	A	@ $T_C=97^\circ\text{C}$, 180° conduction half sine wave
I_{FSM} Max. Peak One Cycle Non-Repetitive Surge Current	850	A	10ms Sine pulse, rated V_{RRM} applied
	1000		10ms Sine pulse, no voltage reapplied
I^2t Max. I^2t for fusing	3600	A^2s	10ms Sine pulse, rated V_{RRM} applied
	5100		10ms Sine pulse, no voltage reapplied
$I^2\sqrt{t}$ Max. $I^2\sqrt{t}$ for fusing	51000	$\text{A}^2\sqrt{\text{s}}$	10ms, no voltage reapplied

Electrical Specifications

Parameters	70EPF..	Units	Conditions
V_{FM} Max. Forward Voltage Drop	1.33	V	@ 70A, $T_J = 25^\circ\text{C}$
r_t Forward slope resistance	3.65	m Ω	$T_J = 150^\circ\text{C}$
$V_{F(TO)}$ Threshold voltage	0.918	V	
I_{RM} Max. Reverse Leakage Current	0.1	mA	$T_J = 25^\circ\text{C}$
	13		$T_J = 150^\circ\text{C}$

Recovery Characteristics

Parameters	70EPF..	Units	Conditions
t_{rr} Reverse Recovery Time	200	ns	$I_F @ 70\text{Apk}$ @ 25A/ μs
I_{rr} Reverse Recovery Current	4	A	
Q_{rr} Reverse Recovery Charge	0.67	μC	@ 25°C
S Snap Factor	0.5		

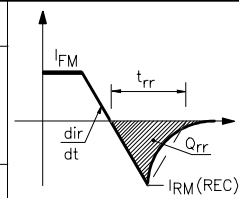

Thermal-Mechanical Specifications

Parameters		70EPF..	Units	Conditions
T_J	Max. Junction Temperature Range	-40 to 150	°C	
T_{stg}	Max. Storage Temperature Range	-40 to 150	°C	
R_{thJC}	Max. Thermal Resistance Junction to Case	0.35	°C/W	DC operation
R_{thJA}	Max. Thermal Resistance Junction to Ambient	40	°C/W	
R_{thCS}	Typical Thermal Resistance, Case to Heatsink	0.2	°C/W	Mounting surface, smooth and greased
wt	Approximate Weight	6(0.21)	g(oz.)	
T	Mounting Torque	Min.	6(5)	Kg-cm (lbf-in)
		Max.	12(10)	
Case Style		<i>PowIRtab</i> TM		

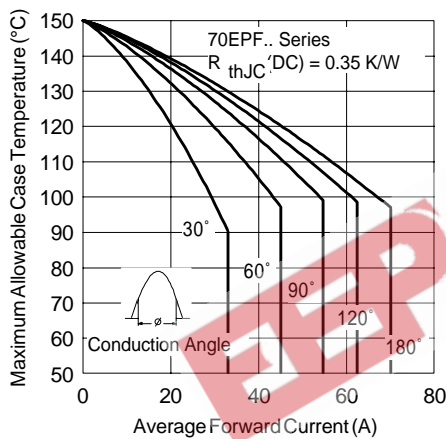

Fig. 1 - Current Rating Characteristics

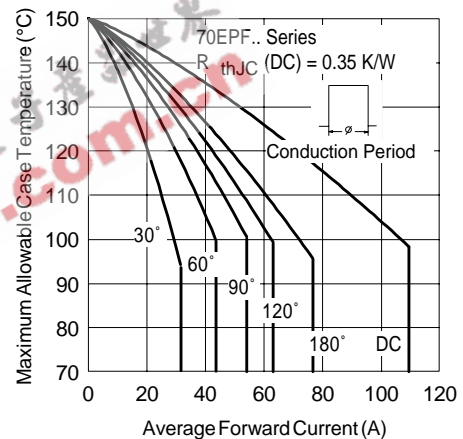

Fig. 2 - Current Rating Characteristics

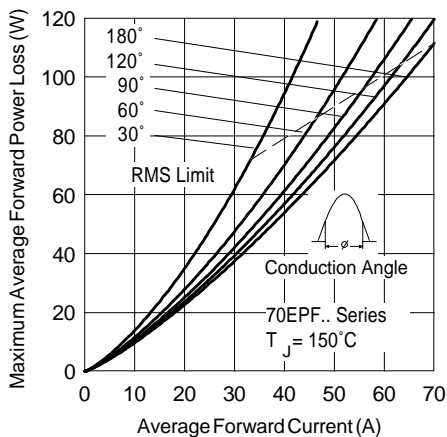

Fig. 3 - Forward Power Loss Characteristics

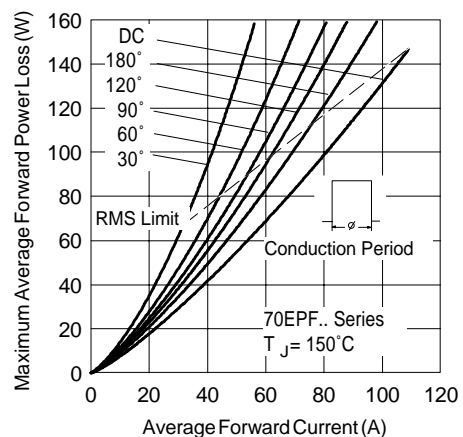

Fig. 4 - Forward Power Loss Characteristics

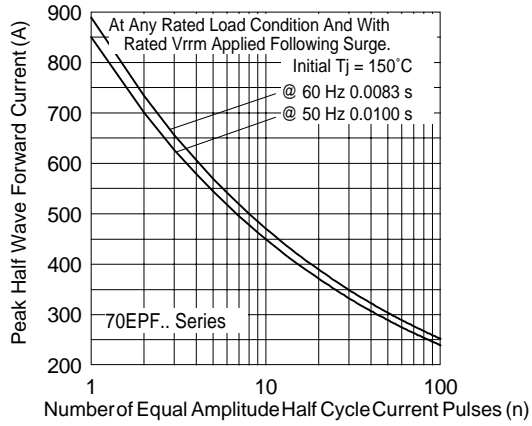

Fig. 5 - Maximum Non-Repetitive Surge Current

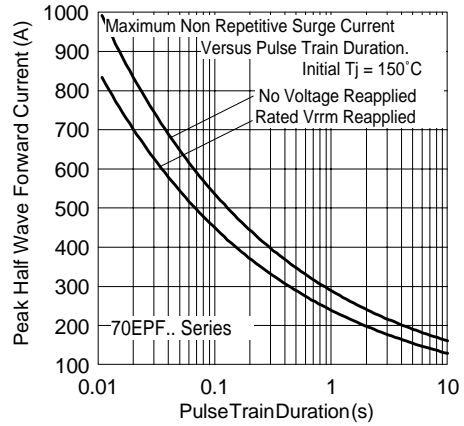

Fig. 6 - Maximum Non-Repetitive Surge Current

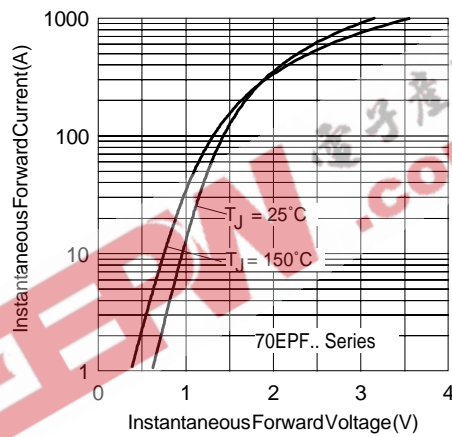

Fig. 7 - Forward Voltage Drop Characteristics

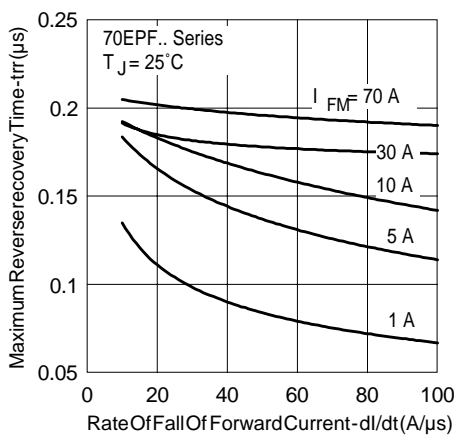

Fig. 8 - Recovery Time Characteristics, $T_J = 25^\circ\text{C}$

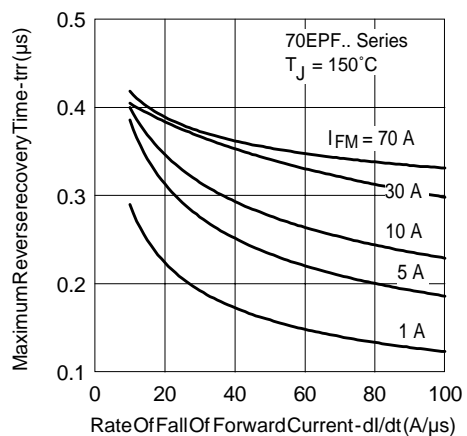

Fig. 9 - Recovery Time Characteristics, $T_J = 150^\circ\text{C}$

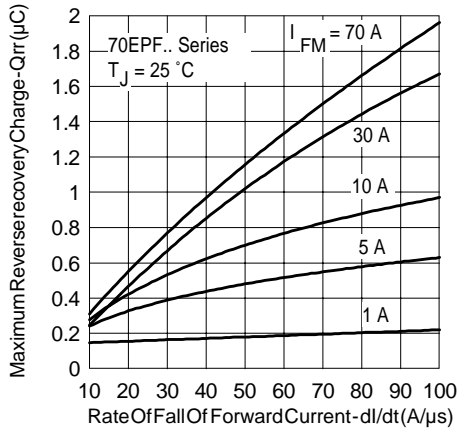

Fig. 10 - Recovery Charge Characteristics, $T_J = 25^\circ\text{C}$

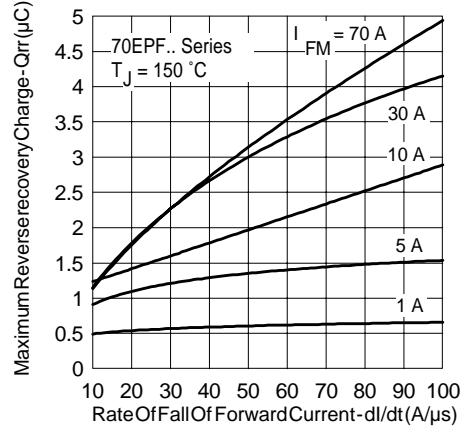

Fig. 11 - Recovery Charge Characteristics, $T_J = 150^\circ\text{C}$

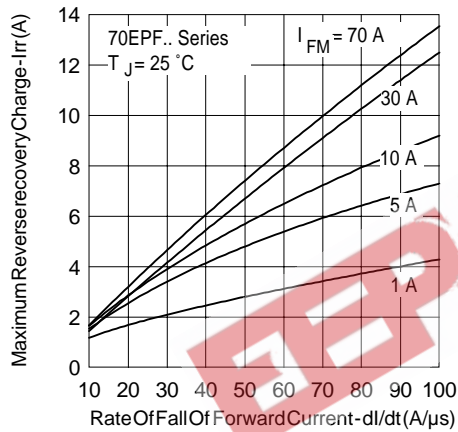

Fig. 12 - Recovery Current Characteristics, $T_J = 25^\circ\text{C}$

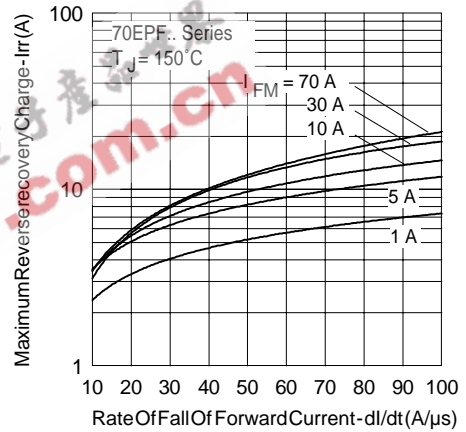

Fig. 13 - Recovery Current Characteristics, $T_J = 150^\circ\text{C}$

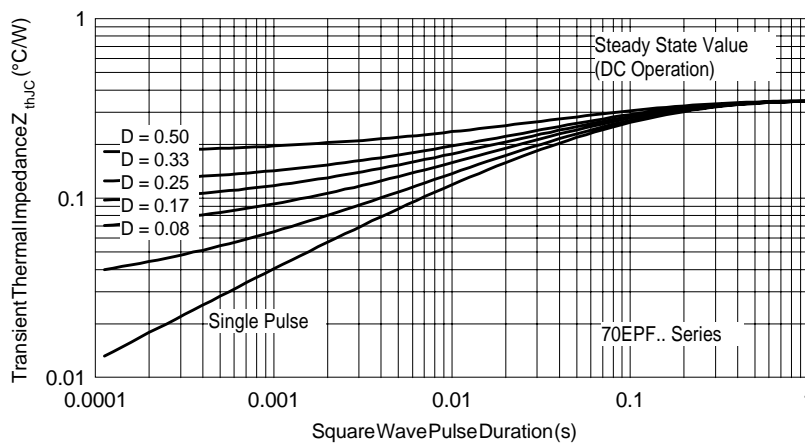
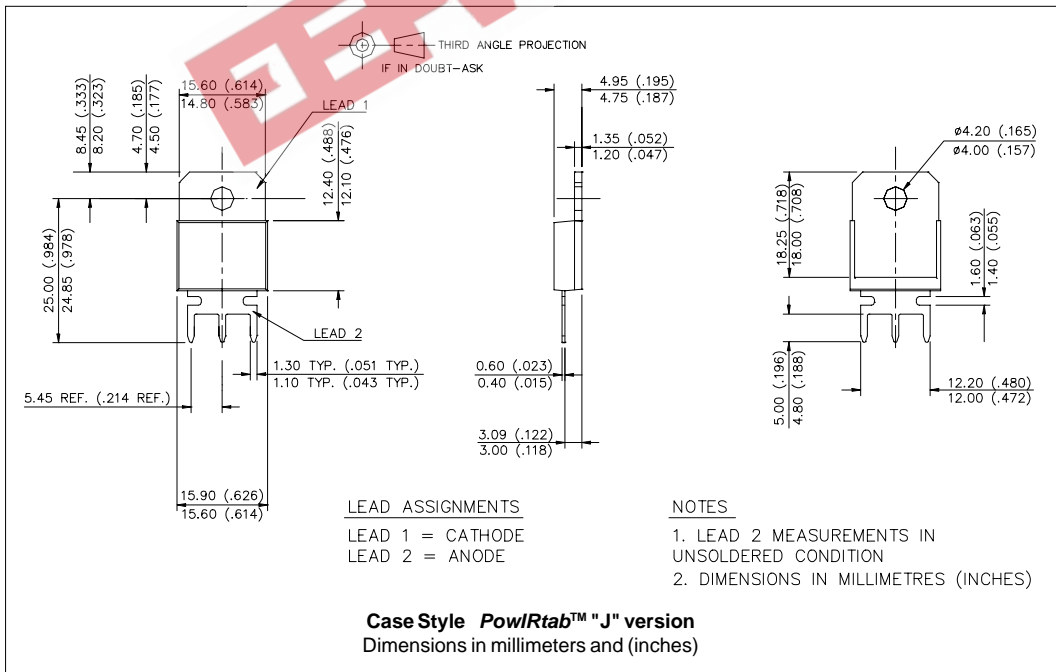
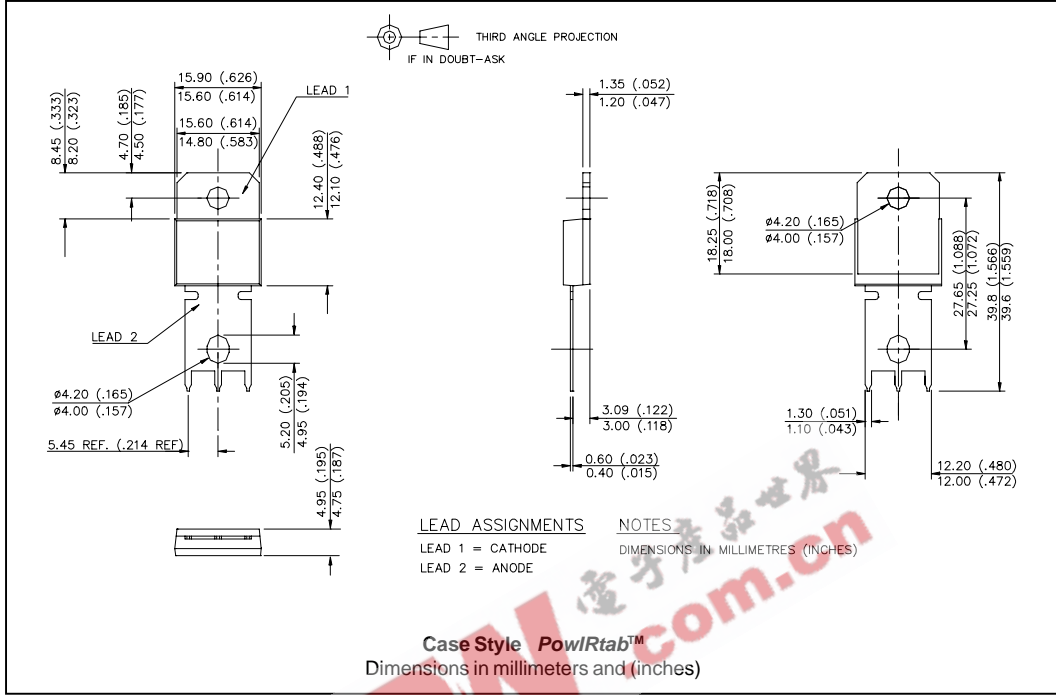

Fig. 14 - Thermal Impedance Z_{thJC} Characteristics

Outline Table



Ordering Information Table

Device Code	
70	E P F 06 J
①	② ③ ④ ⑤ ⑥
1	- Current Rating
2	- Circuit Configuration: E = Single Diode
3	- Package: P = TO-247AC
4	- Type of Silicon: F = Fast Recovery
5	- Voltage code: Code x 100 = V_{RRM} (*)
6	- none = PowIRtab™ standard J = Short Lead Version

02 = 200V
04 = 400V
06 = 600V

(*) for higher voltage up to 1600V contact factory

Data and specifications subject to change without notice.
 This product has been designed and qualified for Industrial Level.
 Qualification Standards can be found on IR's Web site.