

STANDARD RECOVERY DIODES

Stud Version

Features

- Diffused diode
- Wide current range
- High voltage ratings up to 1600V
- High surge current capabilities
- Stud cathode and stud anode version

250A

Typical Applications

- Converters
- Power supplies
- Machine tool controls
- High power drives
- Medium traction applications

Major Ratings and Characteristics

Parameters	70/300U(R)..D	Units
$I_{F(AV)}$	250	A
@ T_C	145	°C
$I_{F(RMS)}$	390	A
I_{FSM} @ 50Hz	6550	A
@ 60Hz	6850	A
I^2t @ 50Hz	214	KA ² s
@ 60Hz	195	KA ² s
V_{RRM} range	1200 to 1600	V
T_J	- 40 to 200	°C

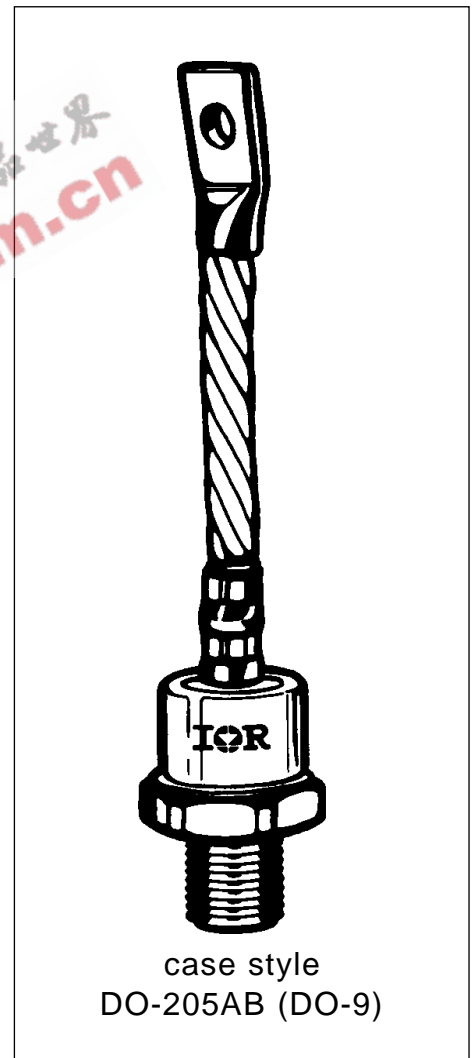

70/300U(R)..D Series

ELECTRICAL SPECIFICATIONS

Voltage Ratings

Type number	Voltage Code	V_{RRM} , maximum repetitive peak reverse voltage V	V_{RSM} , maximum non-repetitive peak rev. voltage V	I_{RRM} max. @ $T_J = T_J$ max. mA
70/300U(R)..D	120	1200	1300	60
	160	1600	1700	

Forward Conduction

Parameter	70/300U(R)..D	Units	Conditions
$I_{F(AV)}$ Max. average forward current @ Case temperature	250	A	180° conduction, half sine wave
	145	°C	
$I_{F(RMS)}$ Max. RMS forward current	390	A	DC @ 134°C case temperature
I_{FSM} Max. peak, one-cycle forward, non-repetitive surge current	6550	A	t = 10ms No voltage
	6850		t = 8.3ms reapplied
	5500		t = 10ms 100% V_{RRM}
	5750		t = 8.3ms reapplied
I^2t Maximum I^2t for fusing	214	KA ² s	t = 10ms No voltage
	195		t = 8.3ms reapplied
	151		t = 10ms 100% V_{RRM}
	138		t = 8.3ms reapplied
$I^2\sqrt{t}$ Maximum $I^2\sqrt{t}$ for fusing	2140	KA ² √s	t = 0.1 to 10ms, no voltage reapplied
$V_{F(TO)1}$ Low level value of threshold voltage	0.61	V	$(16.7\% \times \pi \times I_{F(AV)} < I < \pi \times I_{F(AV)})$, $T_J = T_J$ max.
$V_{F(TO)2}$ High level value of threshold voltage	0.83		$(I > \pi \times I_{F(AV)})$, $T_J = T_J$ max.
r_{f1} Low level value of forward slope resistance	0.75	mΩ	$(16.7\% \times \pi \times I_{F(AV)} < I < \pi \times I_{F(AV)})$, $T_J = T_J$ max.
r_{f2} High level value of forward slope resistance	0.49		$(I > \pi \times I_{F(AV)})$, $T_J = T_J$ max.
V_{FM} Max. forward voltage drop	1.30	V	$I_{pk} = 785A$, $T_J = 25^\circ C$, $t_p = 10ms$ sinusoidal wave

Thermal and Mechanical Specifications

Parameter	70/300U(R)..D	Units	Conditions
T _J Max. junction operating temperature range	-40 to 200	°C	
T _{stg} Max. storage temperature range	-40 to 200		
R _{thJC} Max. thermal resistance, junction to case	0.18	K/W	DC operation
R _{thCS} Max. thermal resistance, case to heatsink	0.08		Mounting surface, smooth, flat and greased
T Max. allowed mounting torque +0 -20%	37	Nm	Not lubricated threads
	28		Lubricated threads
wt Approximate weight	250	g	
Case style	DO-205AB (DO-9)		See Outline Table

 ΔR_{thJC} Conduction

(The following table shows the increment of thermal resistance R_{thJC} when devices operate at different conduction angles than DC)

Conduction angle	Sinusoidal conduction	Rectangular conduction	Units	Conditions
180°	0.020	0.015	K/W	T _J = T _J max.
120°	0.024	0.025		
90°	0.031	0.034		
60°	0.045	0.047		
30°	0.077	0.077		

Ordering Information Table

Device Code	
300 U F R 160 A Y P D	
(1) (2) (3) (4) (5) (6) (7) (8) (9)	
1	- 300 = Standard 300U device 70 = Standard 70U device 302 = 300U Top Threaded version 72 = 70U Top Threaded version
2	- U = Essential Part Number
3	- F = Flat Base (with Pinch Bolt) None = Normal Stud
4	- R = Stud Reverse Polarity (Anode to Stud) None = Stud Normal Polarity (Cathode to Stud)
5	- Voltage code: Code x 10 = V _{RRM} (See Voltage Ratings table)
6	- A = Essential Part Number only for 300U Series None = 70U Series
7	- Y = European Lead None = Standard Lead
8	- P = Forward Selection (1.045V < V _{FM} < 1.125V, I _{FM} = 470A, T _J = 25°C)
9	- D = Diffused diode

70/300U(R)..D Series

Outline Table

GLASS-METAL SEAL

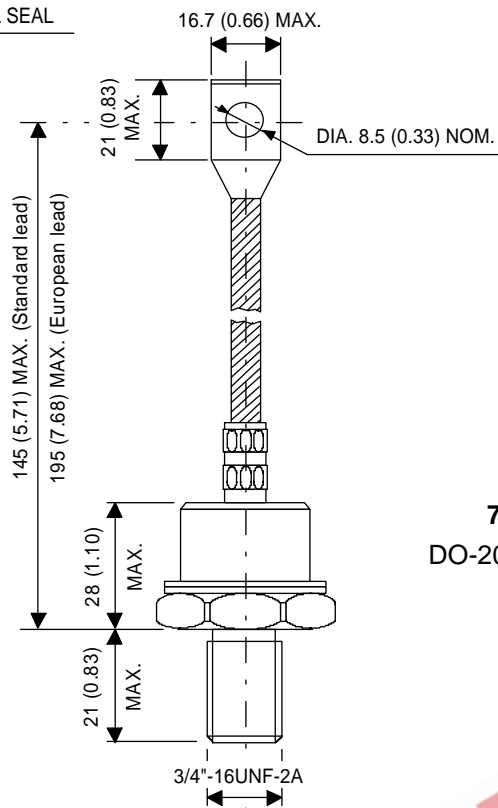

70/300U
DO-205AB (DO-9)

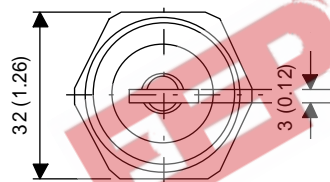

GLASS-METAL SEAL

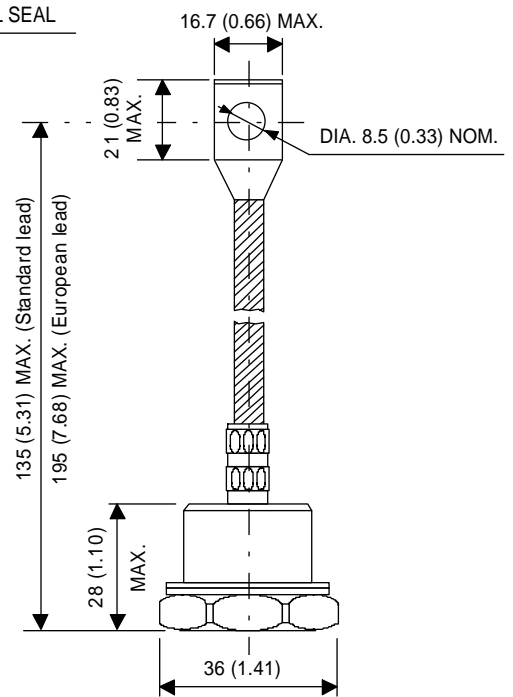

70/300UF
DO-205AB (DO-9)
Flat Base

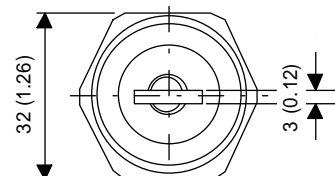

All dimensions in millimeters (inches)

Outline Table

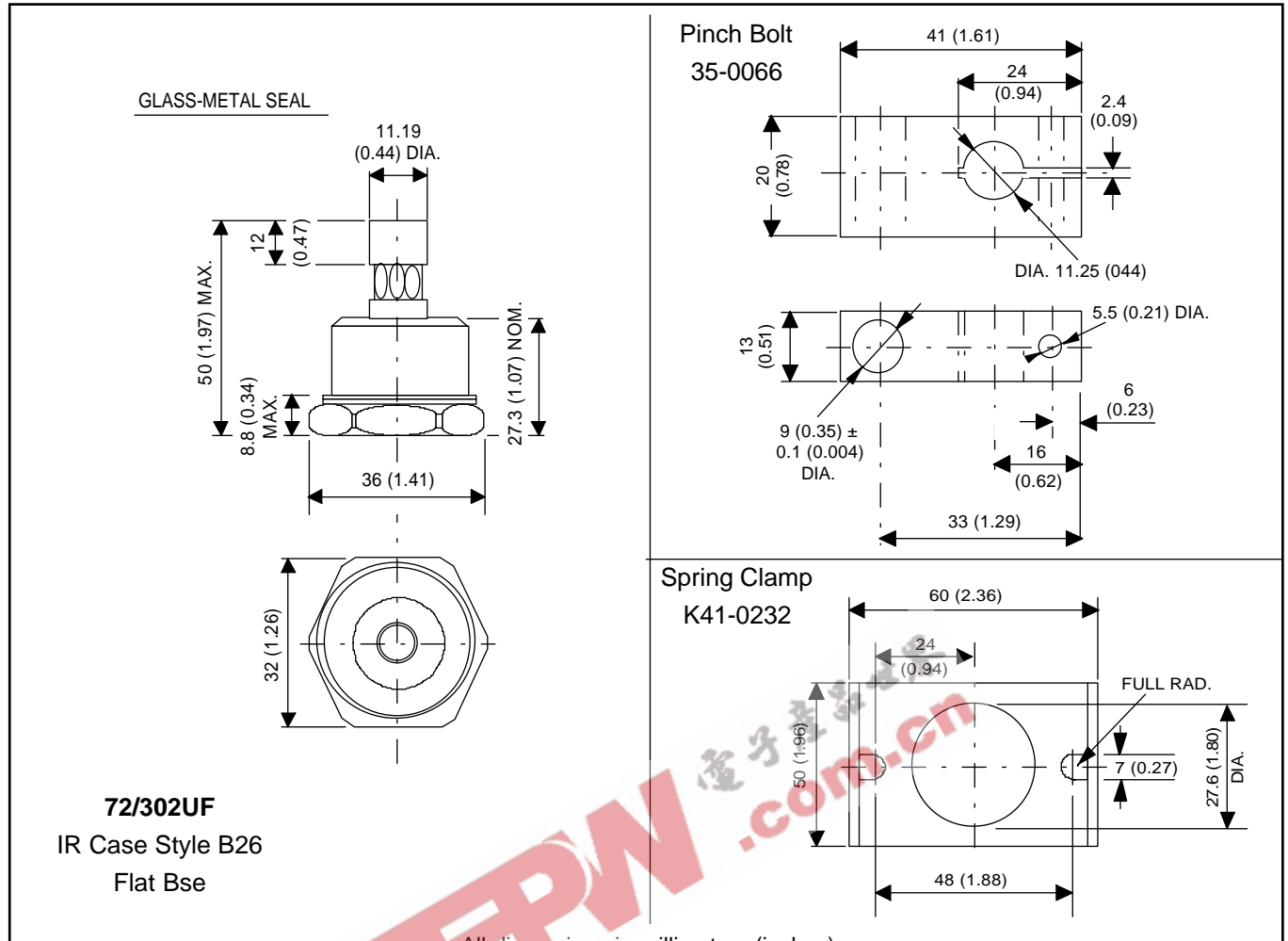

All dimensions in millimeters (inches)

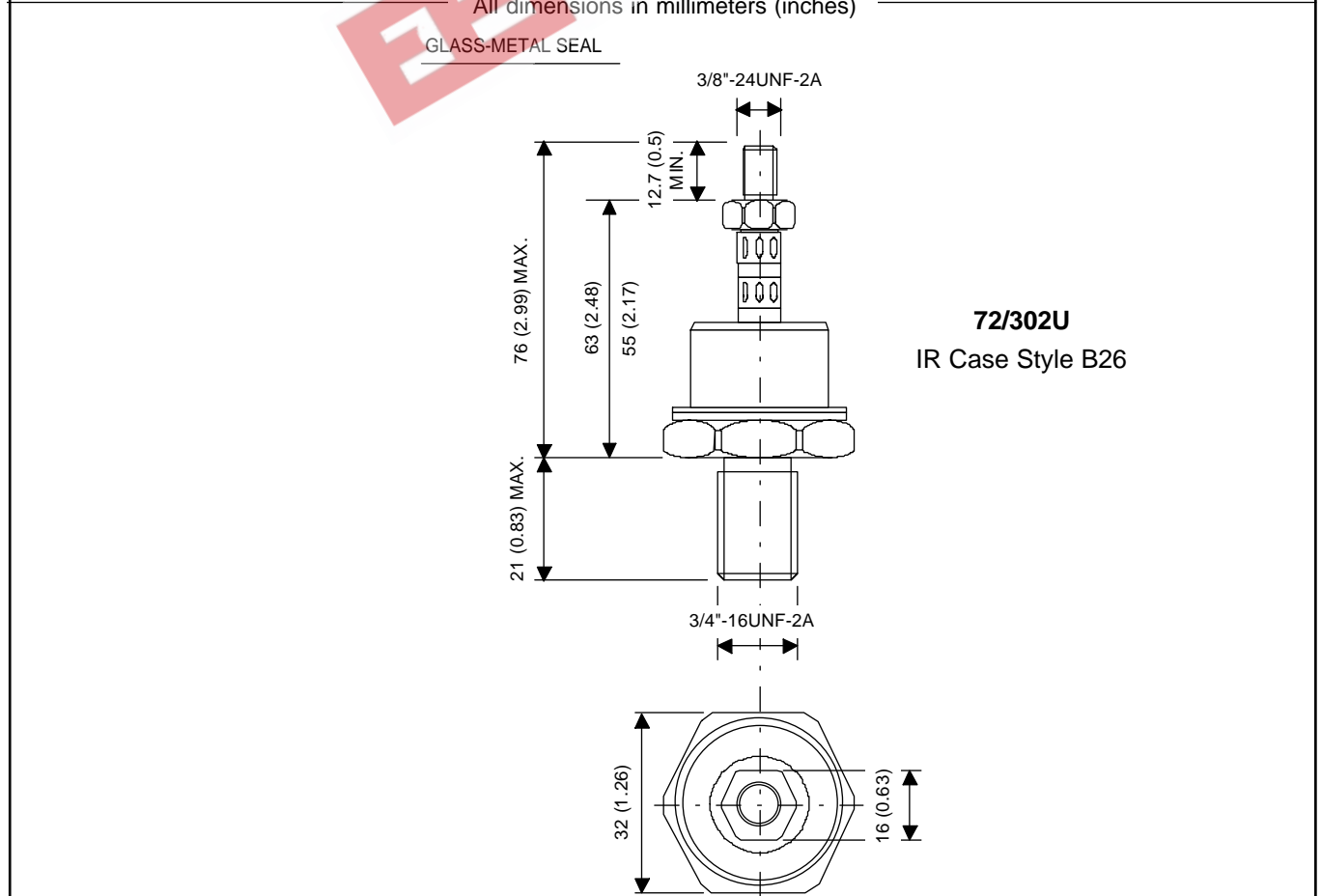

70/300U(R)..D Series

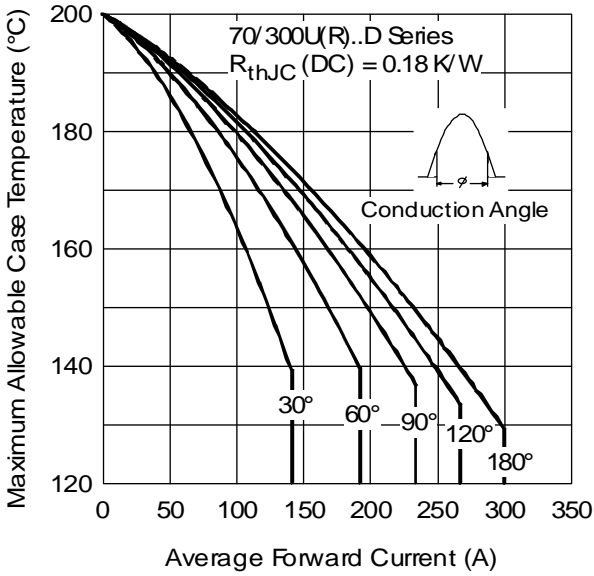

Fig. 1 - Current Ratings Characteristics

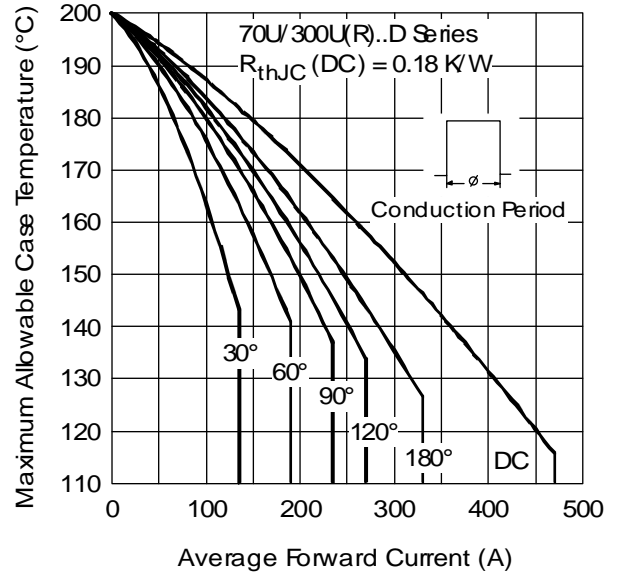

Fig. 2 - Current Ratings Characteristics

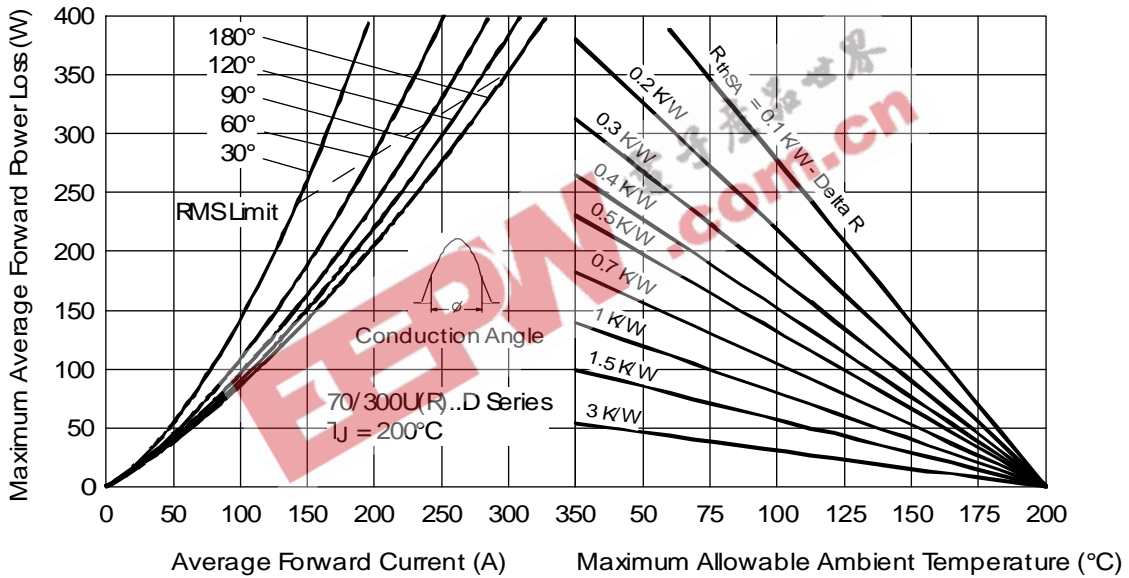

Fig. 3 - Forward Power Loss Characteristics

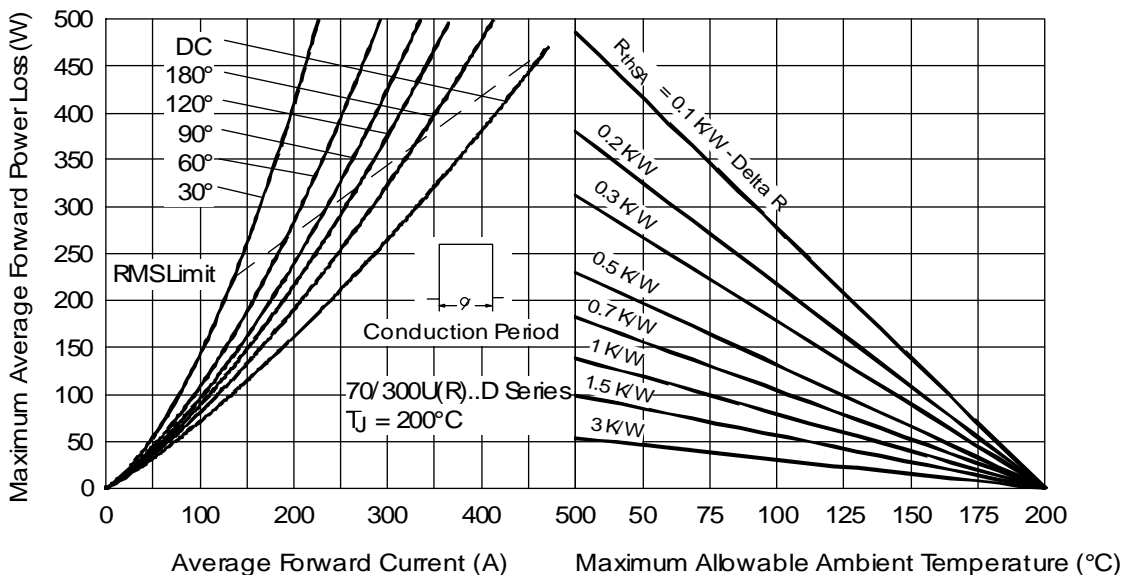

Fig. 4 - Forward Power Loss Characteristics

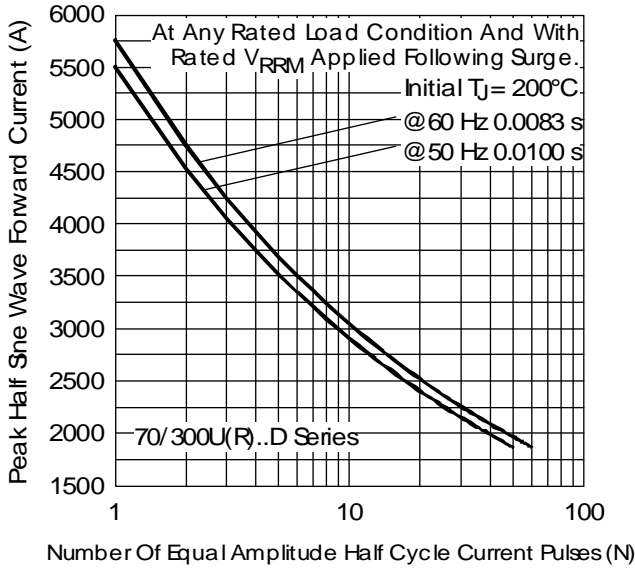

Fig. 5 - Maximum Non-Repetitive Surge Current

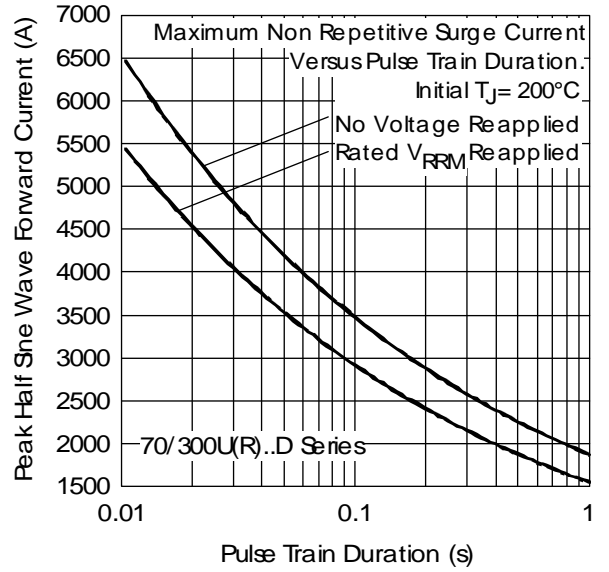

Fig. 6 - Maximum Non-Repetitive Surge Current

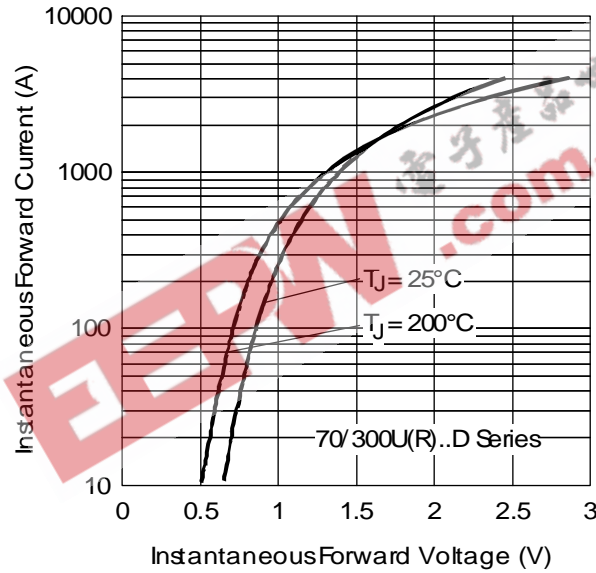

Fig. 7 - Forward Voltage Drop Characteristics

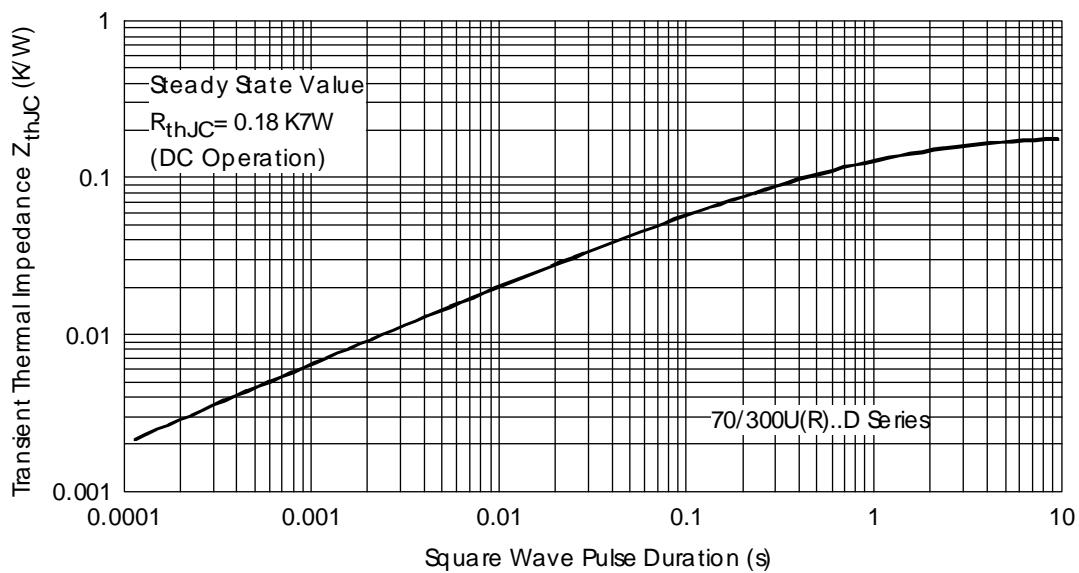

Fig. 8 - Thermal Impedance Z_{thJC} Characteristic