

## 54F/74F280 9-Bit Parity Generator/Checker

### General Description

The 'F280 is a high-speed parity generator/checker that accepts nine bits of input data and detects whether an even or an odd number of these inputs is HIGH. If an even number of inputs is HIGH, the Sum Even output is HIGH. If an odd number is HIGH, the Sum Even output is LOW. The Sum Odd output is the complement of the Sum Even output.

### Features

- Guaranteed 4000V minimum ESD protection

Commercial	Military	Package Number	Package Description
74F280PC		N14A	14-Lead (0.300" Wide) Molded Dual-In-Line
	54F280DM (Note 2)	J14A	14-Lead Ceramic Dual-In-Line
74F280SC (Note 1)		M14A	14-Lead (0.150" Wide) Molded Small Outline, JEDEC
74F280SJ (Note 1)		M14D	14-Lead (0.300" Wide) Molded Small Outline, EIAJ
	54F280FM (Note 2)	W14B	14-Lead Cerpack
	54F280LM (Note 2)	E20A	20-Lead Ceramic Leadless Chip Carrier, Type C

**Note 1:** Devices also available in 13" reel. Use suffix = SCX and SJX.

**Note 2:** Military grade device with environmental and burn-in processing. Use suffix = DMQB, FMQB and LMQB.

### Logic Symbols

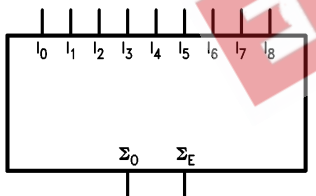

TL/F/9512-3

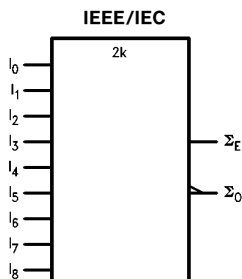

TL/F/9512-5

### Connection Diagrams

Pin Assignment for  
DIP, SOIC and Flatpak

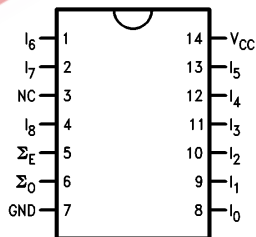

TL/F/9512-1

Pin Assignment  
for LCC

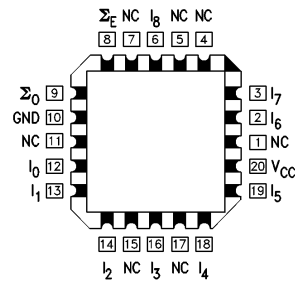

TL/F/9512-2

TRI-STATE® is a registered trademark of National Semiconductor Corporation.

## Unit Loading/Fan Out

Pin Names	Description	54F/74F	
		U.L. HIGH/LOW	Input $I_{IH}/I_{IL}$ Output $I_{OH}/I_{OL}$
$I_0-I_8$	Data Inputs	1.0/1.0	$20 \mu\text{A}/-0.6 \text{ mA}$
$\Sigma_O$	Odd Parity Output	50/33.3	$-1 \text{ mA}/20 \text{ mA}$
$\Sigma_E$	Even Parity Output	50/33.3	$-1 \text{ mA}/20 \text{ mA}$

## Truth Table

Number of HIGH Inputs $I_0-I_8$	Outputs	
	$\Sigma$ Even	$\Sigma$ Odd
0, 2, 4, 6, 8	H	L
1, 3, 5, 7, 9	L	H

H = HIGH Voltage Level  
L = LOW Voltage Level

## Logic Diagram

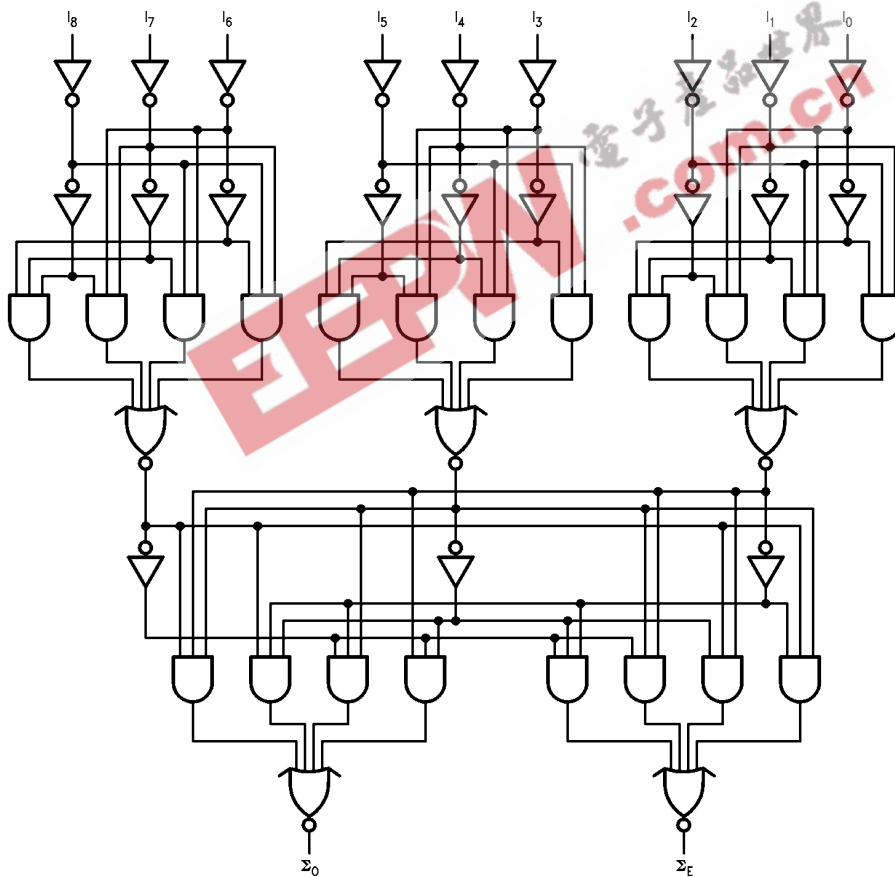

TL/F/9512-4

Please note that this diagram is provided only for the understanding of logic operations and should not be used to estimate propagation delays.

## Absolute Maximum Ratings (Note 1)

If Military/Aerospace specified devices are required, please contact the National Semiconductor Sales Office/Distributors for availability and specifications.

Storage Temperature	-65°C to +150°C
Ambient Temperature under Bias	-55°C to +125°C
Junction Temperature under Bias	-55°C to +175°C
Plastic	-55°C to +150°C
V <sub>CC</sub> Pin Potential to Ground Pin	-0.5V to +7.0V
Input Voltage (Note 2)	-0.5V to +7.0V
Input Current (Note 2)	-30 mA to +5.0 mA
Voltage Applied to Output in HIGH State (with V <sub>CC</sub> = 0V)	
Standard Output	-0.5V to V <sub>CC</sub>
TRI-STATE® Output	-0.5V to +5.5V
Current Applied to Output in LOW State (Max)	twice the rated I <sub>OL</sub> (mA)
ESD Last Passing Voltage (Min)	4000V

**Note 1:** Absolute maximum ratings are values beyond which the device may be damaged or have its useful life impaired. Functional operation under these conditions is not implied.

**Note 2:** Either voltage limit or current limit is sufficient to protect inputs.

## Recommended Operating Conditions

Free Air Ambient Temperature	
Military	-55°C to +125°C
Commercial	0°C to +70°C
Supply Voltage	
Military	+4.5V to +5.5V
Commercial	+4.5V to +5.5V

## DC Electrical Characteristics

Symbol	Parameter	54F/74F			Units	V <sub>CC</sub>	Conditions
		Min	Typ	Max			
V <sub>IH</sub>	Input HIGH Voltage	2.0			V		Recognized as a HIGH Signal
V <sub>IL</sub>	Input LOW Voltage			0.8	V		Recognized as a LOW Signal
V <sub>CD</sub>	Input Clamp Diode Voltage			-1.2	V	Min	I <sub>IN</sub> = -18 mA
V <sub>OH</sub>	Output HIGH Voltage	54F 10% V <sub>CC</sub> 74F 10% V <sub>CC</sub> 74F 5% V <sub>CC</sub>	2.5 2.5 2.7		V	Min	I <sub>OH</sub> = -1 mA I <sub>OH</sub> = -1 mA I <sub>OH</sub> = -1 mA
V <sub>OL</sub>	Output LOW Voltage	54F 10% V <sub>CC</sub> 74F 10% V <sub>CC</sub>		0.5 0.5	V	Min	I <sub>OL</sub> = 20 mA I <sub>OL</sub> = 20 mA
I <sub>IH</sub>	Input HIGH Current	54F 74F		20.0 5.0	μA	Max	V <sub>IN</sub> = 2.7V
I <sub>BVI</sub>	Input HIGH Current Breakdown Test	54F 74F		100 7.0	μA	Max	V <sub>IN</sub> = 7.0V
I <sub>CEX</sub>	Output HIGH Leakage Current	54F 74F		250 50	μA	Max	V <sub>OUT</sub> = V <sub>CC</sub>
V <sub>ID</sub>	Input Leakage Test	74F	4.75		V	0.0	I <sub>ID</sub> = 1.9 μA All Other Pins Grounded
I <sub>OD</sub>	Output Leakage Circuit Current	74F		3.75	μA	0.0	V <sub>IOD</sub> = 150 mV All Other Pins Grounded
I <sub>IL</sub>	Input LOW Current			-0.6	mA	Max	V <sub>IN</sub> = 0.5V
I <sub>OS</sub>	Output Short-Circuit Current		-60	-150	mA	Max	V <sub>OUT</sub> = 0V
I <sub>CCH</sub>	Power Supply Current		25	38	mA	Max	V <sub>O</sub> = HIGH

## AC Electrical Characteristics

Symbol	Parameter	74F			54F		74F		Units
		T <sub>A</sub> = +25°C V <sub>CC</sub> = +5.0V C <sub>L</sub> = 50 pF			T <sub>A</sub> , V <sub>CC</sub> = Mil C <sub>L</sub> = 50 pF		T <sub>A</sub> , V <sub>CC</sub> = Com C <sub>L</sub> = 50 pF		
		Min	Typ	Max	Min	Max	Min	Max	
t <sub>PLH</sub> t <sub>PHL</sub>	Propagation Delay I <sub>n</sub> to Σ <sub>E</sub>	6.5	10.0	15.0	6.5	20.0	6.5	16.0	ns
t <sub>PLH</sub> t <sub>PHL</sub>	Propagation Delay I <sub>n</sub> to Σ <sub>O</sub>	6.0	10.0	15.0	5.0	20.0	6.0	16.0	
		6.5	11.0	16.0	6.5	21.0	6.5	17.0	

## Ordering Information

The device number is used to form part of a simplified purchasing code where the package type and temperature range are defined as follows:

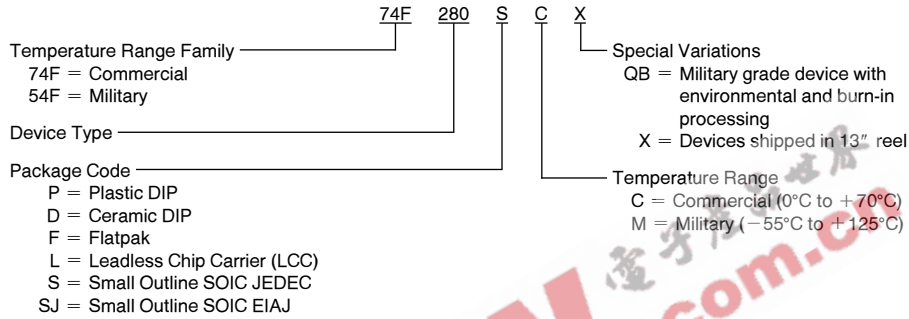

**Physical Dimensions** inches (millimeters)

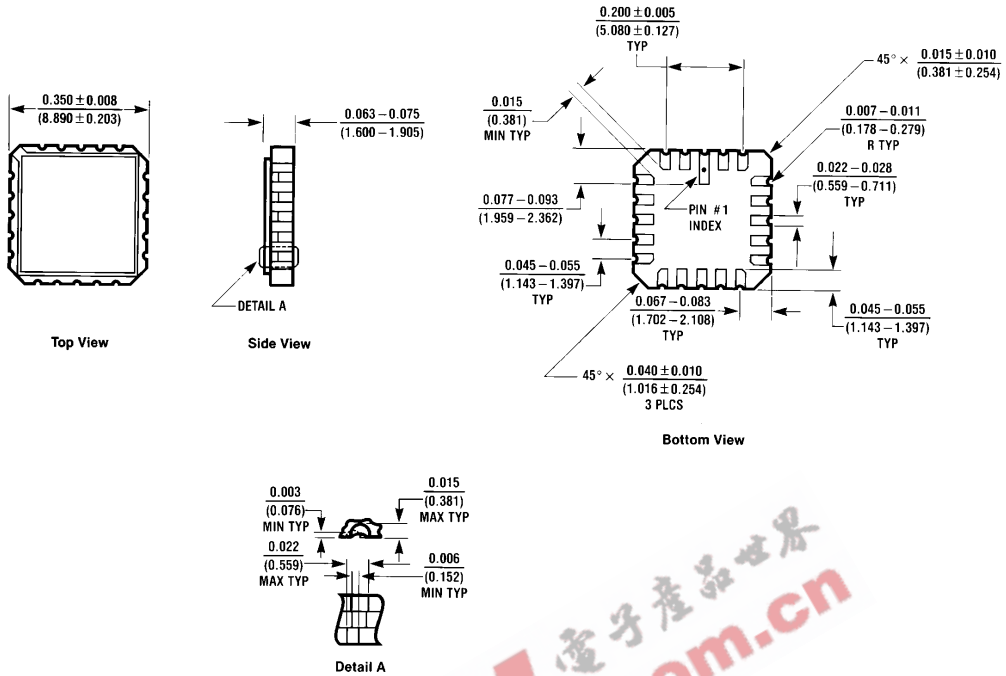

**20-Lead Ceramic Leadless Chip Carrier (L)**  
**NS Package Number E20A**

E20A (REV. D)

EPW.com.cn 电子产品世界

**Physical Dimensions** inches (millimeters) (Continued)

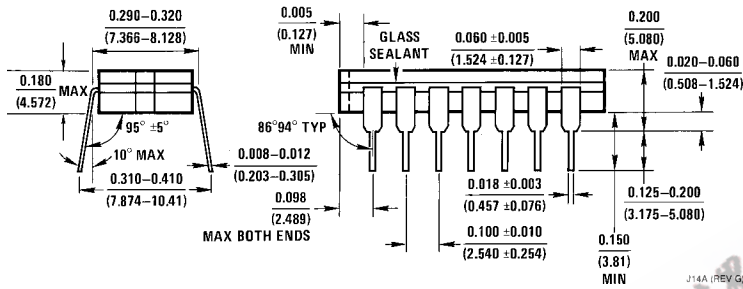
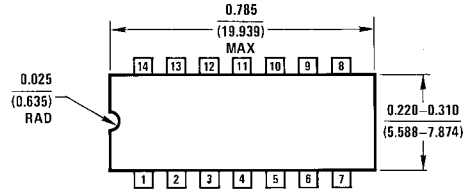

**14-Lead Ceramic Dual-In-Line Package (D)**  
NS Package Number J14A

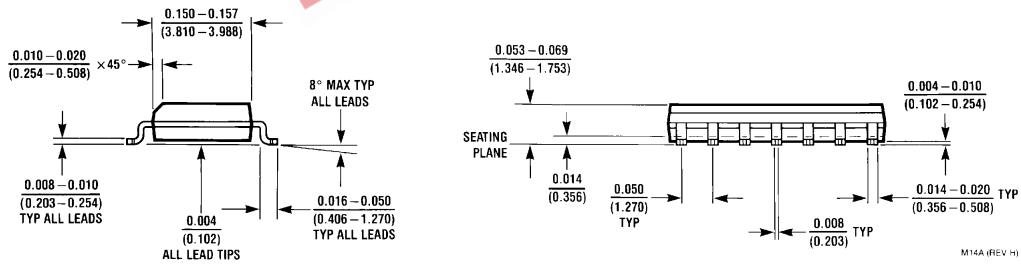
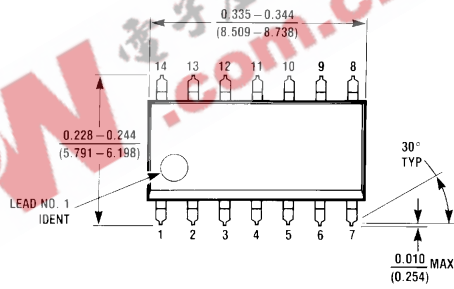

**14-Lead (0.150" Wide) Molded Small Outline Package, JEDEC (S)**  
NS Package Number M14A

**Physical Dimensions** inches (millimeters) (Continued)

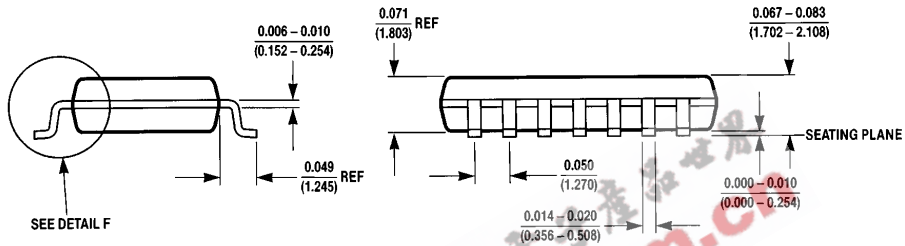
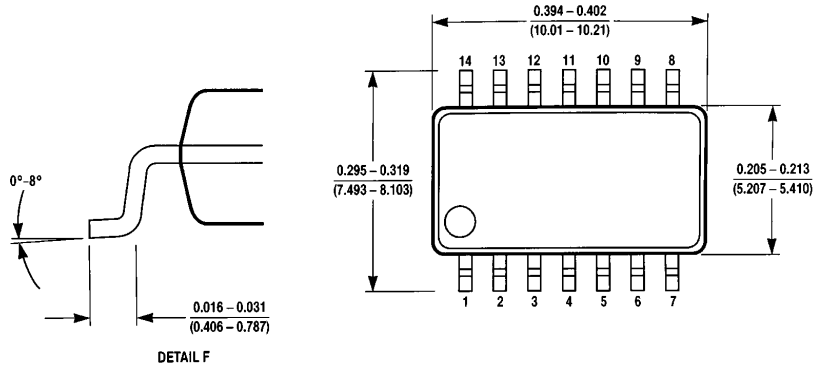

**14-Lead (0.300" Wide) Molded Small Outline Package, EIAJ (SJ)**  
NS Package Number M14D

M14D (REV A)

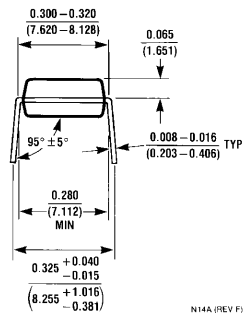
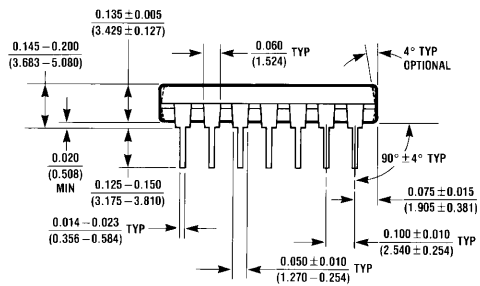
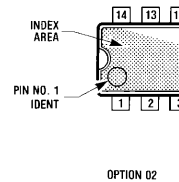
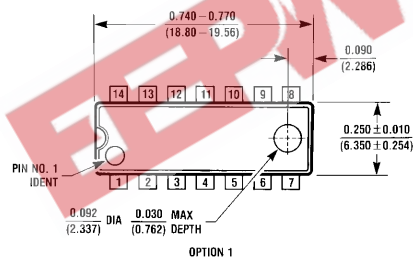

N14A (REV F)

**14-Lead (0.300" Wide) Molded Dual-In-Line Package (P)**  
NS Package Number N14A

**Physical Dimensions** inches (millimeters) (Continued)

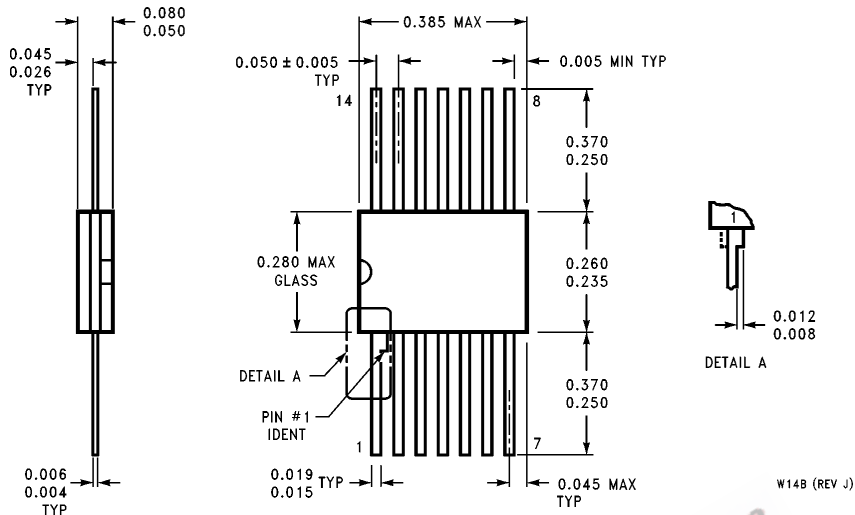

**14-Lead Ceramic Flatpak (F)  
NS Package Number W14B**

W14B (REV J)



**LIFE SUPPORT POLICY**

NATIONAL'S PRODUCTS ARE NOT AUTHORIZED FOR USE AS CRITICAL COMPONENTS IN LIFE SUPPORT DEVICES OR SYSTEMS WITHOUT THE EXPRESS WRITTEN APPROVAL OF THE PRESIDENT OF NATIONAL SEMICONDUCTOR CORPORATION. As used herein:

1. Life support devices or systems are devices or systems which, (a) are intended for surgical implant into the body, or (b) support or sustain life, and whose failure to perform, when properly used in accordance with instructions for use provided in the labeling, can be reasonably expected to result in a significant injury to the user.
2. A critical component is any component of a life support device or system whose failure to perform can be reasonably expected to cause the failure of the life support device or system, or to affect its safety or effectiveness.



**National Semiconductor Corporation**  
1111 West Bardin Road  
Arlington, TX 76017  
Tel: 1(800) 272-9959  
Fax: 1(800) 737-7018

**National Semiconductor Europe**  
Fax: (+49) 0-180-590 85 86  
Email: cnjwge@tevm2.nsc.com  
Deutsch Tel: (+49) 0-180-530 85 85  
English Tel: (+49) 0-180-532 78 32  
Français Tel: (+49) 0-180-532 93 58  
Italiano Tel: (+49) 0-180-534 16 80

**National Semiconductor Hong Kong Ltd.**  
13th Floor, Straight Block,  
Ocean Centre, 5 Canton Rd.  
Tsimshatsui, Kowloon  
Hong Kong  
Tel: (852) 2737-1600  
Fax: (852) 2736-9960

**National Semiconductor Japan Ltd.**  
Tel: 81-043-299-2309  
Fax: 81-043-299-2408