

SN74LS240 SN74LS244

Octal Buffer/Line Driver with 3-State Outputs

The SN74LS240 and SN74LS244 are Octal Buffers and Line Drivers designed to be employed as memory address drivers, clock drivers and bus-oriented transmitters/receivers which provide improved PC board density.

- Hysteresis at Inputs to Improve Noise Margins
- 3-State Outputs Drive Bus Lines or Buffer Memory Address Registers
- Input Clamp Diodes Limit High-Speed Termination Effects

GUARANTEED OPERATING RANGES

Symbol	Parameter	Min	Typ	Max	Unit
V _{CC}	Supply Voltage	4.75	5.0	5.25	V
T _A	Operating Ambient Temperature Range	0	25	70	°C
I _{OH}	Output Current – High			-3.0	mA
				-15	mA
I _{OL}	Output Current – Low			24	mA



ON Semiconductor
Formerly a Division of Motorola
<http://onsemi.com>

**LOW
POWER
SCHOTTKY**

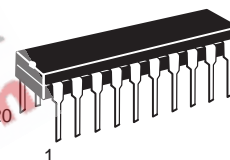

PLASTIC
N SUFFIX
CASE 738

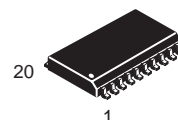

SOIC
DW SUFFIX
CASE 751D

ORDERING INFORMATION

Device	Package	Shipping
SN74LS240N	16 Pin DIP	1440 Units/Box
SN74LS240DW	16 Pin	2500/Tape & Reel
SN74LS244N	16 Pin DIP	1440 Units/Box
SN74LS244DW	16 Pin	2500/Tape & Reel

SN74LS240 SN74LS244

LOGIC AND CONNECTION DIAGRAMS DIP (TOP VIEW)

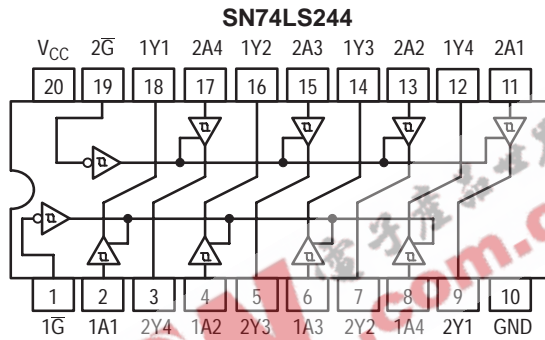
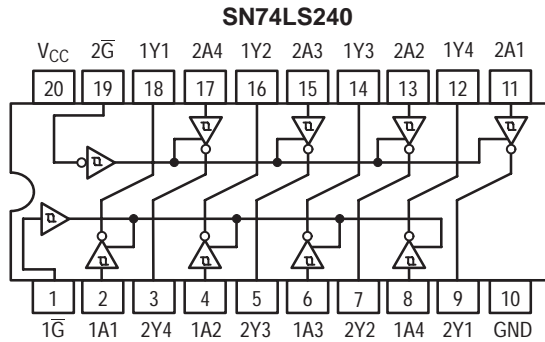

TRUTH TABLES

SN74LS240

INPUTS		OUTPUT
1G, 2G	D	
L	L	H
L	H	L
H	X	(Z)

SN74LS244

INPUTS		OUTPUT
1G, 2G	D	
L	L	L
L	H	H
H	X	(Z)

H = HIGH Voltage Level
 L = LOW Voltage Level
 X = Immaterial
 Z = HIGH Impedance

SN74LS240 SN74LS244

DC CHARACTERISTICS OVER OPERATING TEMPERATURE RANGE (unless otherwise specified)

Symbol	Parameter	Limits			Unit	Test Conditions
		Min	Typ	Max		
V _{IH}	Input HIGH Voltage	2.0			V	Guaranteed Input HIGH Voltage for All Inputs
V _{IL}	Input LOW Voltage			0.8	V	Guaranteed Input LOW Voltage for All Inputs
V _{T+} -V _{T-}	Hysteresis	0.2	0.4		V	V _{CC} = MIN
V _{IK}	Input Clamp Diode Voltage		-0.65	-1.5	V	V _{CC} = MIN, I _{IN} = -18 mA
V _{OH}	Output HIGH Voltage	2.4	3.4		V	V _{CC} = MIN, I _{OH} = -3.0 mA
		2.0			V	V _{CC} = MIN, I _{OH} = MAX
V _{OL}	Output LOW Voltage		0.25	0.4	V	I _{OL} = 12 mA
			0.35	0.5	V	I _{OL} = 24 mA
I _{OZH}	Output Off Current HIGH			20	μA	V _{CC} = MAX, V _{OUT} = 2.7 V
I _{OZL}	Output Off Current LOW			-20	μA	V _{CC} = MAX, V _{OUT} = 0.4 V
I _{IH}	Input HIGH Current			20	μA	V _{CC} = MAX, V _{IN} = 2.7 V
				0.1	mA	V _{CC} = MAX, V _{IN} = 7.0 V
I _{IL}	Input LOW Current			-0.2	mA	V _{CC} = MAX, V _{IN} = 0.4 V
I _{OS}	Output Short Circuit Current (Note 1)	-40		-225	mA	V _{CC} = MAX
I _{CC}	Power Supply Current Total, Output HIGH			27	mA	V _{CC} = MAX
	Total, Output LOW	LS240		44		
		LS244		46		
	Total at HIGH Z	LS240		50		
		LS244		54		

Note 1: Not more than one output should be shorted at a time, nor for more than 1 second.

AC CHARACTERISTICS (T_A = 25°C, V_{CC} = 5.0 V)

Symbol	Parameter	Limits			Unit	Test Conditions
		Min	Typ	Max		
t _{PLH} t _{PHL}	Propagation Delay, Data to Output LS240		9.0 12	14 18	ns	C _L = 45 pF, R _L = 667 Ω
t _{PLH} t _{PHL}	Propagation Delay, Data to Output LS244		12 12	18 18	ns	
t _{PZH}	Output Enable Time to HIGH Level		15	23	ns	
t _{PZL}	Output Enable Time to LOW Level		20	30	ns	
t _{PLZ}	Output Disable Time from LOW Level		15	25	ns	C _L = 5.0 pF, R _L = 667 Ω
t _{PHZ}	Output Disable Time from HIGH Level		10	18	ns	

SN74LS240 SN74LS244

AC WAVEFORMS

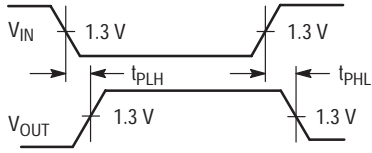

Figure 1.

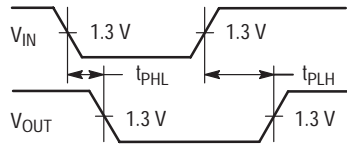

Figure 2.

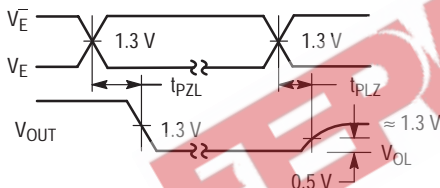

Figure 3.

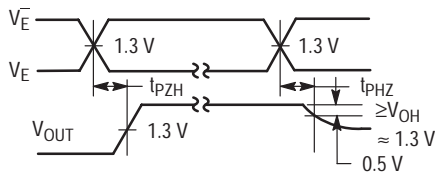
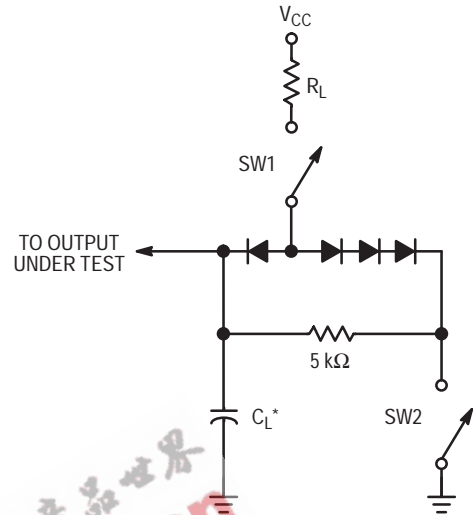

Figure 4.



SWITCH POSITIONS

SYMBOL	SW1	SW2
t_{PZH}	Open	Closed
t_{PZL}	Closed	Open
t_{PLZ}	Closed	Closed
t_{PHZ}	Closed	Closed

Figure 5.

SN74LS240 SN74LS244

PACKAGE DIMENSIONS

N SUFFIX
PLASTIC PACKAGE
CASE 738-03
ISSUE E

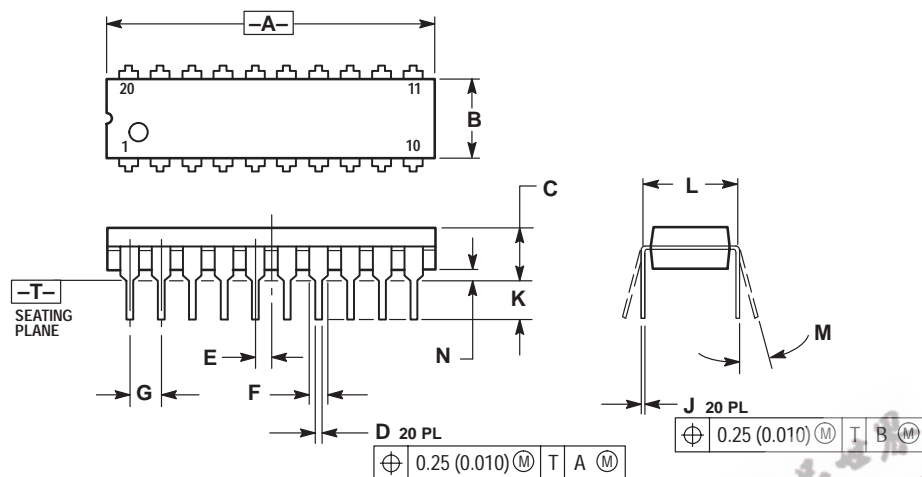

- NOTES:
1. DIMENSIONING AND TOLERANCING PER ANSI Y14.5M, 1982.
 2. CONTROLLING DIMENSION: INCH.
 3. DIMENSION L TO CENTER OF LEAD WHEN FORMED PARALLEL.
 4. DIMENSION B DOES NOT INCLUDE MOLD FLASH.

DIM	INCHES		MILLIMETERS	
	MIN	MAX	MIN	MAX
A	1.010	1.070	25.66	27.17
B	0.240	0.260	6.10	6.60
C	0.150	0.180	3.81	4.57
D	0.015	0.022	0.39	0.55
E	0.050 BSC		1.27 BSC	
F	0.050	0.070	1.27	1.77
G	0.100 BSC		2.54 BSC	
J	0.008	0.015	0.21	0.38
K	0.110	0.140	2.80	3.55
L	0.300 BSC		7.62 BSC	
M	0°	15°	0°	15°
N	0.020	0.040	0.51	1.01

EPW.com.cn 电子產品世界

SN74LS240 SN74LS244

D SUFFIX
PLASTIC SOIC PACKAGE
CASE 751D-05
ISSUE F

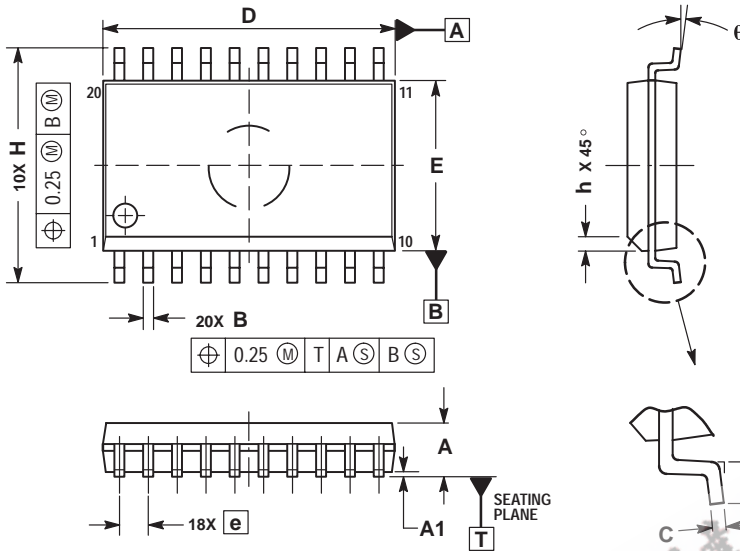

NOTES:

1. DIMENSIONS ARE IN MILLIMETERS.
2. INTERPRET DIMENSIONS AND TOLERANCES PER ASME Y14.5M, 1994.
3. DIMENSIONS D AND E DO NOT INCLUDE MOLD PROTRUSION.
4. MAXIMUM MOLD PROTRUSION 0.15 PER SIDE.
5. DIMENSION B DOES NOT INCLUDE DAMBAR PROTRUSION. ALLOWABLE PROTRUSION SHALL BE 0.13 TOTAL IN EXCESS OF B DIMENSION AT MAXIMUM MATERIAL CONDITION.

DIM	MILLIMETERS	
	MIN	MAX
A	2.35	2.65
A1	0.10	0.25
B	0.35	0.49
C	0.23	0.32
D	12.65	12.95
E	7.40	7.60
e	1.27 BSC	
H	10.05	10.55
h	0.25	0.75
L	0.50	0.90
theta	0°	7°

EEPW.com.cn 电子产业世界

SN74LS240 SN74LS244

Notes

EEPW 电子产品世界
.com.cn

SN74LS240 SN74LS244

EEPW 电子產品世界 .com.cn

ON Semiconductor and  are trademarks of Semiconductor Components Industries, LLC (SCILLC). SCILLC reserves the right to make changes without further notice to any products herein. SCILLC makes no warranty, representation or guarantee regarding the suitability of its products for any particular purpose, nor does SCILLC assume any liability arising out of the application or use of any product or circuit, and specifically disclaims any and all liability, including without limitation special, consequential or incidental damages. "Typical" parameters which may be provided in SCILLC data sheets and/or specifications can and do vary in different applications and actual performance may vary over time. All operating parameters, including "Typicals" must be validated for each customer application by customer's technical experts. SCILLC does not convey any license under its patent rights nor the rights of others. SCILLC products are not designed, intended, or authorized for use as components in systems intended for surgical implant into the body, or other applications intended to support or sustain life, or for any other application in which the failure of the SCILLC product could create a situation where personal injury or death may occur. Should Buyer purchase or use SCILLC products for any such unintended or unauthorized application, Buyer shall indemnify and hold SCILLC and its officers, employees, subsidiaries, affiliates, and distributors harmless against all claims, costs, damages, and expenses, and reasonable attorney fees arising out of, directly or indirectly, any claim of personal injury or death associated with such unintended or unauthorized use, even if such claim alleges that SCILLC was negligent regarding the design or manufacture of the part. SCILLC is an Equal Opportunity/Affirmative Action Employer.

PUBLICATION ORDERING INFORMATION

North America Literature Fulfillment:

Literature Distribution Center for ON Semiconductor
P.O. Box 5163, Denver, Colorado 80217 USA
Phone: 303-675-2175 or 800-344-3860 Toll Free USA/Canada
Fax: 303-675-2176 or 800-344-3867 Toll Free USA/Canada
Email: ONlit@hibbertco.com

N. American Technical Support: 800-282-9855 Toll Free USA/Canada

EUROPE: LDC for ON Semiconductor – European Support

German Phone: (+1) 303-308-7140 (M-F 2:30pm to 5:00pm Munich Time)

Email: ONlit-german@hibbertco.com

French Phone: (+1) 303-308-7141 (M-F 2:30pm to 5:00pm Toulouse Time)

Email: ONlit-french@hibbertco.com

English Phone: (+1) 303-308-7142 (M-F 1:30pm to 5:00pm UK Time)

Email: ONlit@hibbertco.com

ASIA/PACIFIC: LDC for ON Semiconductor – Asia Support

Phone: 303-675-2121 (Tue-Fri 9:00am to 1:00pm, Hong Kong Time)
Toll Free from Hong Kong 800-4422-3781

Email: ONlit-asia@hibbertco.com

JAPAN: ON Semiconductor, Japan Customer Focus Center

4-32-1 Nishi-Gotanda, Shinagawa-ku, Tokyo, Japan 141-8549

Phone: 81-3-5487-8345

Email: r14153@onsemi.com

Fax Response Line: 303-675-2167

800-344-3810 Toll Free USA/Canada

ON Semiconductor Website: <http://onsemi.com>

For additional information, please contact your local Sales Representative.