

# HD74LS76A ● Dual J-K Flip-Flops (with Preset and Clear)

## ■ BLOCK DIAGRAM (1/2)

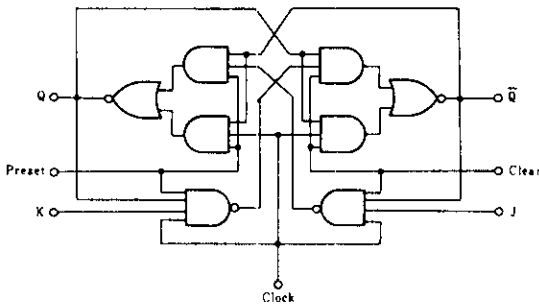

## ■ PIN ARRANGEMENT

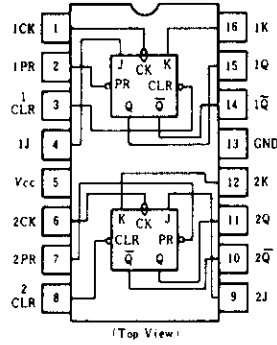

## ■ RECOMMENDED OPERATING CONDITIONS

Item	Symbol	min	typ	max	Unit
Clock frequency	$f_{clock}$	0	—	30	MHz
Pulse width	Clock High	20	—	—	ns
	Clear Preset Low	25	—	—	
Setup time	"H" Data	20↓	—	—	ns
	"L" Data	20↓	—	—	
Hold time	$t_h$	0↓	—	—	ns

## ■ TIMING DEFINITION

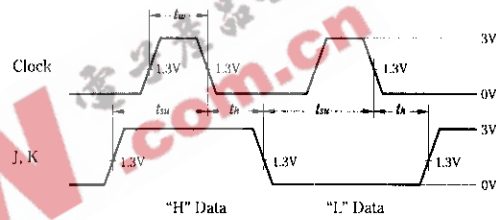

Note) ↓; The arrow indicates the falling edge.

## ■ ELECTRICAL CHARACTERISTICS ( $T_a = -20 \sim +75^\circ\text{C}$ )

Item	Symbol	Test Conditions	min	typ*	max	Unit
Input voltage	$V_{IH}$		2.0	—	—	V
	$V_{IL}$		—	—	0.8	V
Output voltage	$V_{OH}$	$V_{CC} = 4.75\text{V}$ , $V_{IH} = 2\text{V}$ , $V_{IL} = 0.8\text{V}$ , $I_{OH} = -400\mu\text{A}$	2.7	—	—	V
	$V_{OL}$	$V_{CC} = 4.75\text{V}$ , $V_{IH} = 2\text{V}$ , $V_{IL} = 0.8\text{V}$	—	—	0.5	V
Input current	J, K	$V_{CC} = 5.25\text{V}$ , $V_I = 2.7\text{V}$	—	—	20	
	Clear		—	—	60	
	Preset		—	—	60	
	Clock		—	—	80	
	J, K	$V_{CC} = 5.25\text{V}$ , $V_I = 0.4\text{V}$	—	—	-0.4	mA
	Clear		—	—	-0.8	
	Preset		—	—	-0.8	
	Clock		—	—	-0.8	
J, K	$V_{CC} = 5.25\text{V}$ , $V_I = 7\text{V}$	—	—	0.1	mA	
Clear		—	—	0.3		
Preset		—	—	0.3		
Clock		—	—	0.4		
Short-circuit output current	$I_{OS}$	$V_{CC} = 5.25\text{V}$	-20	—	-100	mA
Supply current ***	$I_{CC}$	$V_{CC} = 5.25\text{V}$	—	4	6	mA
Input clamp voltage	$V_{IK}$	$V_{CC} = 4.75\text{V}$ , $I_{IN} = -18\text{mA}$	—	—	-1.5	V

\*  $V_{CC} = 5\text{V}$ ,  $T_a = 25^\circ\text{C}$

\*\*  $I_{IL}$  should not be measured when preset and clear inputs are low at same time.

\*\*\* With all outputs open,  $I_{CC}$  is measured with the Q and  $\bar{Q}$  outputs high in turn. At the time of measurement, the clock input is grounded.

# HD74LS76A

## FUNCTION TABLE

Inputs					Outputs	
Preset	Clear	Clock	J	K	Q	$\bar{Q}$
L	H	X	X	X	H	L
H	L	X	X	X	L	H
L	L	X	X	X	H*	H*
H	H	↓	L	L	Q <sub>0</sub>	$\bar{Q}$ <sub>0</sub>
H	H	↓	H	L	H	L
H	H	↓	L	H	L	H
H	H	↓	H	H	Toggle	
H	H	H	X	X	Q <sub>0</sub>	$\bar{Q}$ <sub>0</sub>

Notes) H; high level, L; low level, X; irrelevant  
 ↓; transition from high to low level  
 Q<sub>0</sub>; level of Q before the indicated steady-state input conditions were established.  
 $\bar{Q}$ <sub>0</sub>; complement of Q<sub>0</sub> or level of  $\bar{Q}$  before the indicated steady-state input conditions were established.  
 Toggle; each output changes to the complement of its previous level on each active transition indicated by ↓.  
 \*; This configuration is nonstable; that is, it will not persist when preset and clear inputs return to their inactive (high) level.

## SWITCHING CHARACTERISTICS (V<sub>CC</sub> = 5V, T<sub>a</sub> = 25°C)

Item	Symbol	Inputs	Outputs	Test Conditions	min	typ	max	Unit
Maximum clock frequency	f <sub>max</sub>				30	45	—	MHz
Propagation delay time	t <sub>PLH</sub>	Clear Preset Clock	Q, $\bar{Q}$	C <sub>L</sub> = 15pF, R <sub>L</sub> = 2kΩ	—	15	20	ns
	t <sub>PHL</sub>				15	20	ns	

## TESTING METHOD

### 1) Test Circuit

1.1) f<sub>max</sub>, t<sub>PLH</sub>, t<sub>PHL</sub> (Clock → Q,  $\bar{Q}$ )

1.2) t<sub>PHL</sub>, t<sub>PLH</sub> (Clear, Preset → Q,  $\bar{Q}$ )

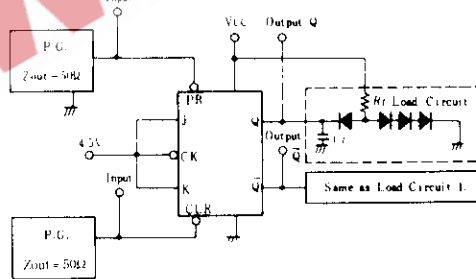
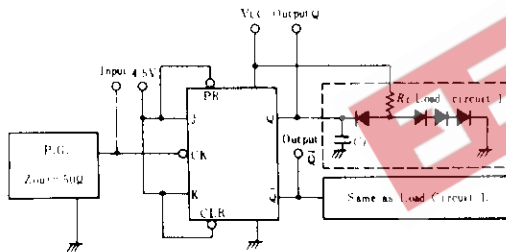

- Notes) 1. Test is put into the each flip-flop  
 2. All diodes are 1S2074 ⊕  
 3. C<sub>L</sub> includes probe and jig capacitance.

### Waveform

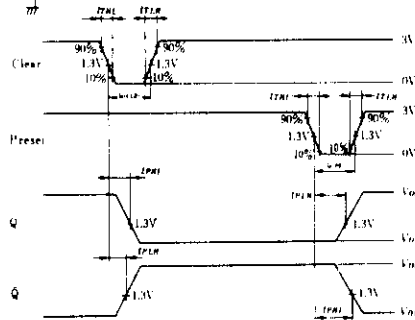
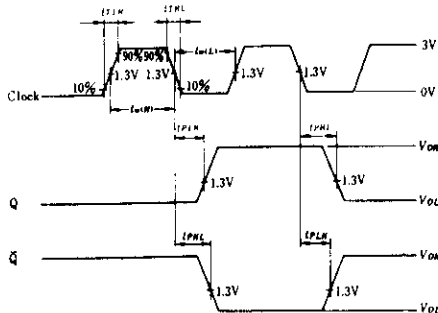

Note) Clear and preset input pulse;  
 $t_{TLH} \leq 15\text{ns}$ ,  $t_{THL} \leq 6\text{ns}$ ,  
 $PRR = 1\text{MHz}$

Note) Clock input pulse;  $t_{TLH} \leq 15\text{ns}$ ,  
 $t_{THL} \leq 6\text{ns}$ ,  $PRR = 1\text{MHz}$ , duty  
 cycle = 50% and; for f<sub>max</sub>,  
 $t_{TLH} = t_{THL} \leq 2.5\text{ns}$ .

EEPW 电子产品世界 .com.cn

Unit: mm

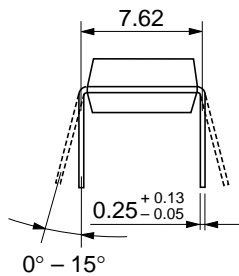
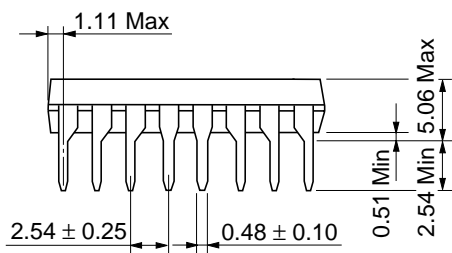
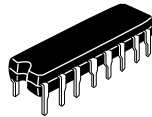
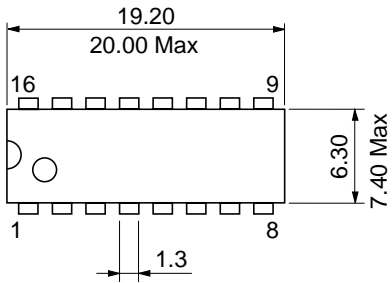

Hitachi Code	DP-16
JEDEC	Conforms
EIAJ	Conforms
Weight (reference value)	1.07 g

Unit: mm

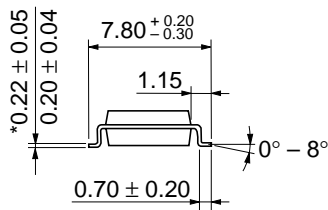
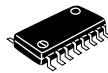
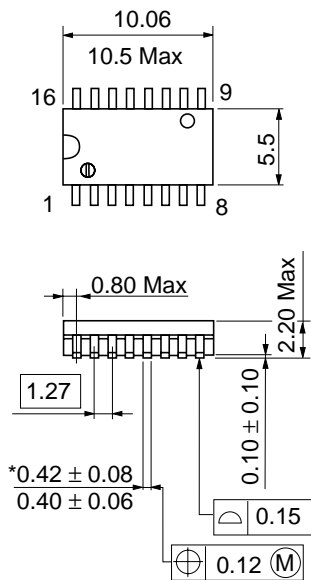

Hitachi Code	FP-16DA
JEDEC	—
EIAJ	Conforms
Weight (reference value)	0.24 g

\*Dimension including the plating thickness  
Base material dimension

Unit: mm

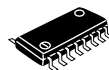
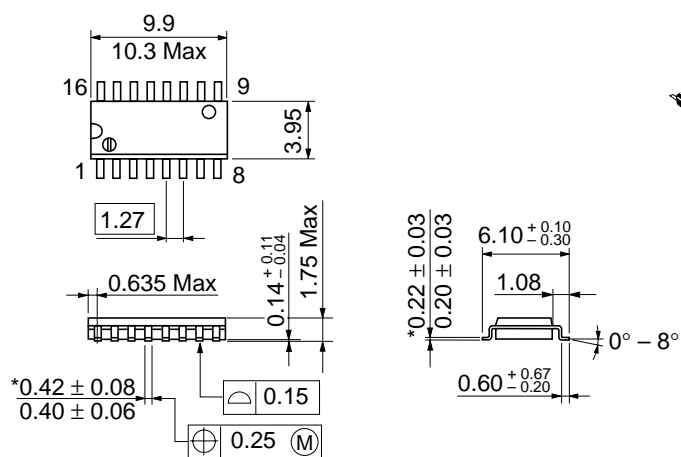

Hitachi Code	FP-16DN
JEDEC	Conforms
EIAJ	Conforms
Weight (reference value)	0.15 g

---

---

## Cautions

1. Hitachi neither warrants nor grants licenses of any rights of Hitachi's or any third party's patent, copyright, trademark, or other intellectual property rights for information contained in this document. Hitachi bears no responsibility for problems that may arise with third party's rights, including intellectual property rights, in connection with use of the information contained in this document.
2. Products and product specifications may be subject to change without notice. Confirm that you have received the latest product standards or specifications before final design, purchase or use.
3. Hitachi makes every attempt to ensure that its products are of high quality and reliability. However, contact Hitachi's sales office before using the product in an application that demands especially high quality and reliability or where its failure or malfunction may directly threaten human life or cause risk of bodily injury, such as aerospace, aeronautics, nuclear power, combustion control, transportation, traffic, safety equipment or medical equipment for life support.
4. Design your application so that the product is used within the ranges guaranteed by Hitachi particularly for maximum rating, operating supply voltage range, heat radiation characteristics, installation conditions and other characteristics. Hitachi bears no responsibility for failure or damage when used beyond the guaranteed ranges. Even within the guaranteed ranges, consider normally foreseeable failure rates or failure modes in semiconductor devices and employ systemic measures such as fail-safes, so that the equipment incorporating Hitachi product does not cause bodily injury, fire or other consequential damage due to operation of the Hitachi product.
5. This product is not designed to be radiation resistant.
6. No one is permitted to reproduce or duplicate, in any form, the whole or part of this document without written approval from Hitachi.
7. Contact Hitachi's sales office for any questions regarding this document or Hitachi semiconductor products.

---

---

# HITACHI

## Hitachi, Ltd.

Semiconductor & Integrated Circuits.  
Nippon Bldg., 2-6-2, Ohte-machi, Chiyoda-ku, Tokyo 100-0004, Japan  
Tel: Tokyo (03) 3270-2111 Fax: (03) 3270-5109

URL      North America      : <http://semiconductor.hitachi.com/>  
             Europe                : <http://www.hitachi-eu.com/hel/ecg>  
             Asia (Singapore)        : <http://www.has.hitachi.com.sg/grp3/sicd/index.htm>  
             Asia (Taiwan)            : [http://www.hitachi.com.tw/E/Product/SICD\\_Frame.htm](http://www.hitachi.com.tw/E/Product/SICD_Frame.htm)  
             Asia (HongKong)        : <http://www.hitachi.com.hk/eng/bo/grp3/index.htm>  
             Japan                        : <http://www.hitachi.co.jp/Sicd/indx.htm>

### For further information write to:

Hitachi Semiconductor  
(America) Inc.  
179 East Tasman Drive,  
San Jose, CA 95134  
Tel: <1> (408) 433-1990  
Fax: <1> (408) 433-0223

Hitachi Europe GmbH  
Electronic components Group  
Dornacher StraÙe 3  
D-85622 Feldkirchen, Munich  
Germany  
Tel: <49> (89) 9 9180-0  
Fax: <49> (89) 9 29 30 00

Hitachi Europe Ltd.  
Electronic Components Group.  
Whitebrook Park  
Lower Cookham Road  
Maidenhead  
Berkshire SL6 8YA, United Kingdom  
Tel: <44> (1628) 585000  
Fax: <44> (1628) 778322

Hitachi Asia Pte. Ltd.  
16 Collyer Quay #20-00  
Hitachi Tower  
Singapore 049318  
Tel: 535-2100  
Fax: 535-1533

Hitachi Asia Ltd.  
Taipei Branch Office  
3F, Hung Kuo Building, No.167,  
Tun-Hwa North Road, Taipei (105)  
Tel: <886> (2) 2718-3666  
Fax: <886> (2) 2718-8180

Hitachi Asia (Hong Kong) Ltd.  
Group III (Electronic Components)  
7/F., North Tower, World Finance Centre,  
Harbour City, Canton Road, Tsim Sha Tsui,  
Kowloon, Hong Kong  
Tel: <852> (2) 735 9218  
Fax: <852> (2) 730 0281  
Telex: 40815 HITEC HX

Copyright ' Hitachi, Ltd., 1999. All rights reserved. Printed in Japan.

**HITACHI**