

# 74HC4067; 74HCT4067

16-channel analog multiplexer/demultiplexer

Rev. 03 — 15 October 2007

Product data sheet

## 1. General description

---

The 74HC4067; 74HCT4067 is a high-speed Si-gate CMOS device and is pin compatible with the HEF4067B. The device is specified in compliance with JEDEC standard no. 7A.

The 74HC4067; 74HCT4067 is a 16-channel analog multiplexer/demultiplexer with four address inputs (S0 to S3), an active-LOW enable input ( $\bar{E}$ ), sixteen independent inputs/outputs (Y0 to Y15) and a common input/output (Z).

The 74HC4067; 74HCT4067 contains sixteen bidirectional analog switches, each with one side connected to an independent input/output (Y0 to Y15) and the other side connected to a common input/output (Z).

With pin  $\bar{E}$  = LOW, one of the sixteen switches is selected by pins S0 to S3 (low impedance ON-state). All unselected switches are in the high-impedance OFF-state. With pin  $\bar{E}$  = HIGH, all switches are in the high-impedance OFF-state, independent of pins S0 to S3.

The analog inputs/outputs (Y0 to Y15, and Z) can swing between  $V_{CC}$  as a positive limit and GND as a negative limit.  $V_{CC}$  to GND may not exceed 10 V.

## 2. Features

---

- Low ON resistance:
  - ◆ 80  $\Omega$  (typical) at  $V_{CC} = 4.5$  V
  - ◆ 70  $\Omega$  (typical) at  $V_{CC} = 6.0$  V
  - ◆ 60  $\Omega$  (typical) at  $V_{CC} = 9.0$  V
- Typical 'break before make' built-in

## 3. Applications

---

- Analog multiplexing and demultiplexing
- Digital multiplexing and demultiplexing
- Signal gating

## 4. Ordering information

Table 1. Ordering information

Type number	Package			Version
	Temperature range	Name	Description	
<b>74HC4067</b>				
74HC4067N	-40 °C to +125 °C	DIP24	plastic dual in-line package; 24 leads (600 mil); reverse bending	SOT101-1
74HC4067D	-40 °C to +125 °C	SO24	plastic small outline package; 24 leads; body width 7.5 mm	SOT137-1
74HC4067DB	-40 °C to +125 °C	SSOP24	plastic shrink small outline package; 24 leads; body width 5.3 mm	SOT340-1
74HC4067PW	-40 °C to +125 °C	TSSOP24	plastic thin shrink small outline package; 24 leads; body width 4.4 mm	SOT355-1
74HC4067BQ	-40 °C to +125 °C	DHVQFN24	plastic dual in-line compatible thermal enhanced very thin quad flat package; no leads; 24 terminals; body 3.5 × 5.5 × 0.85 mm	SOT815-1
<b>74HCT4067</b>				
74HCT4067N	-40 °C to +125 °C	DIP24	plastic dual in-line package; 24 leads (600 mil); reverse bending	SOT101-1
74HCT4067D	-40 °C to +125 °C	SO24	plastic small outline package; 24 leads; body width 7.5 mm	SOT137-1
74HCT4067DB	-40 °C to +125 °C	SSOP24	plastic shrink small outline package; 24 leads; body width 5.3 mm	SOT340-1
74HCT4067PW	-40 °C to +125 °C	TSSOP24	plastic thin shrink small outline package; 24 leads; body width 4.4 mm	SOT355-1
74HCT4067BQ	-40 °C to +125 °C	DHVQFN24	plastic dual in-line compatible thermal enhanced very thin quad flat package; no leads; 24 terminals; body 3.5 × 5.5 × 0.85 mm	SOT815-1

5. Functional diagram

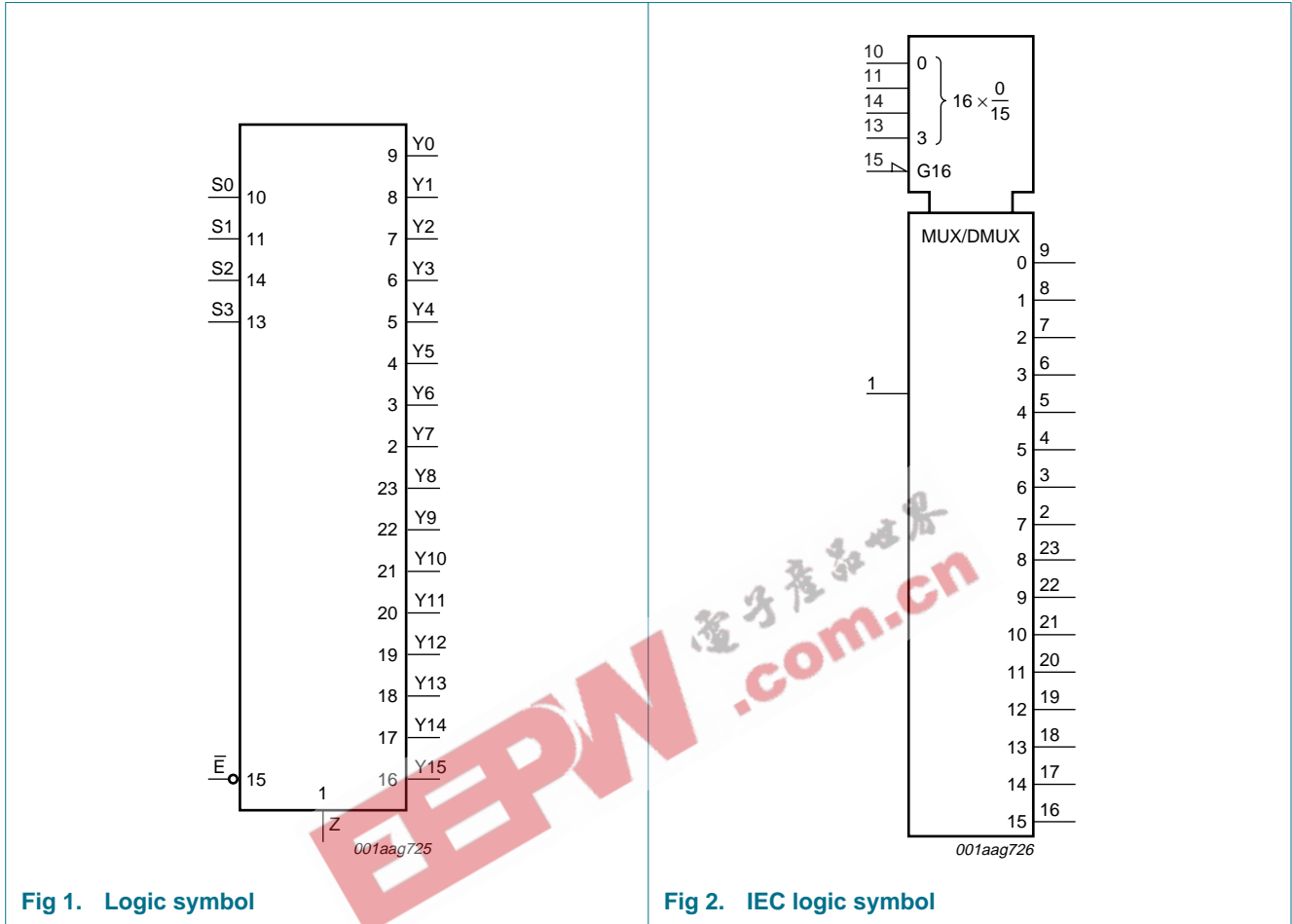

Fig 1. Logic symbol

Fig 2. IEC logic symbol

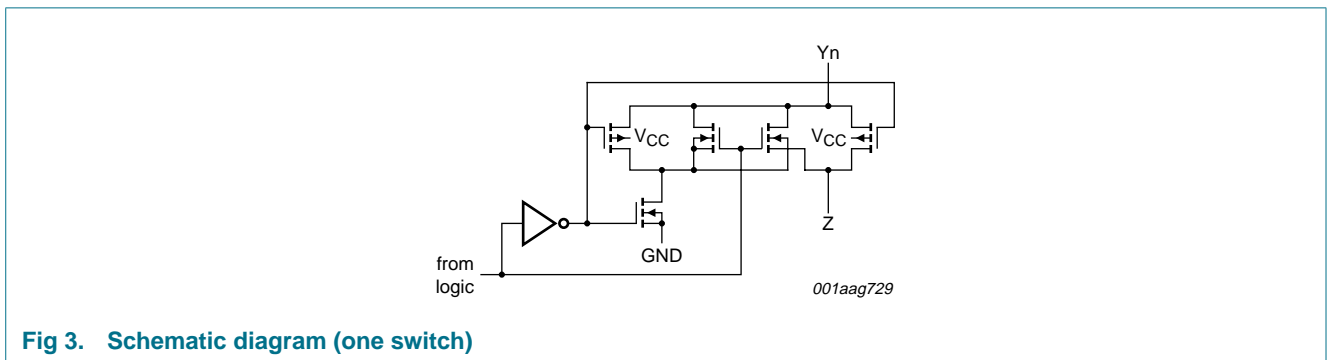

Fig 3. Schematic diagram (one switch)

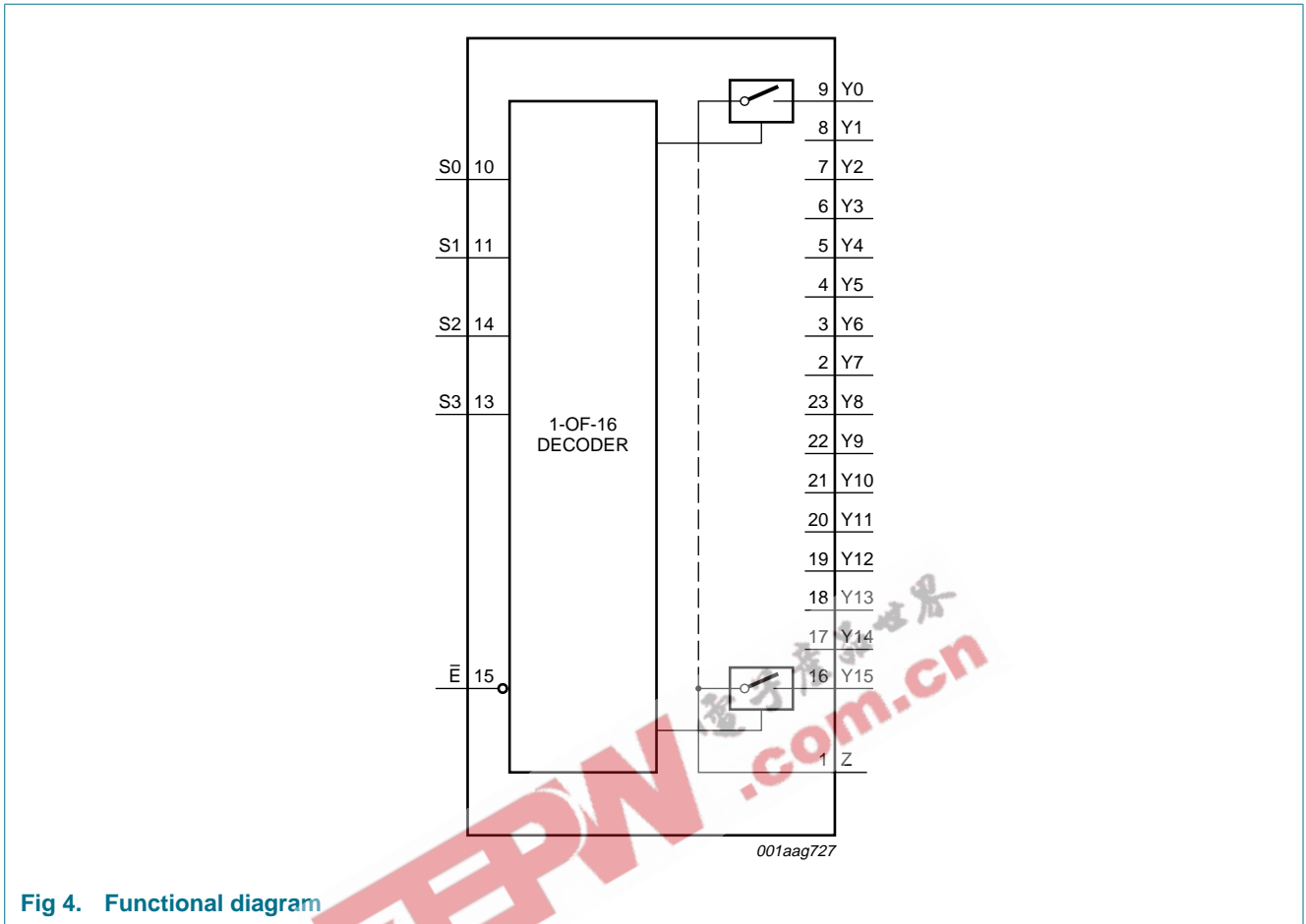

Fig 4. Functional diagram

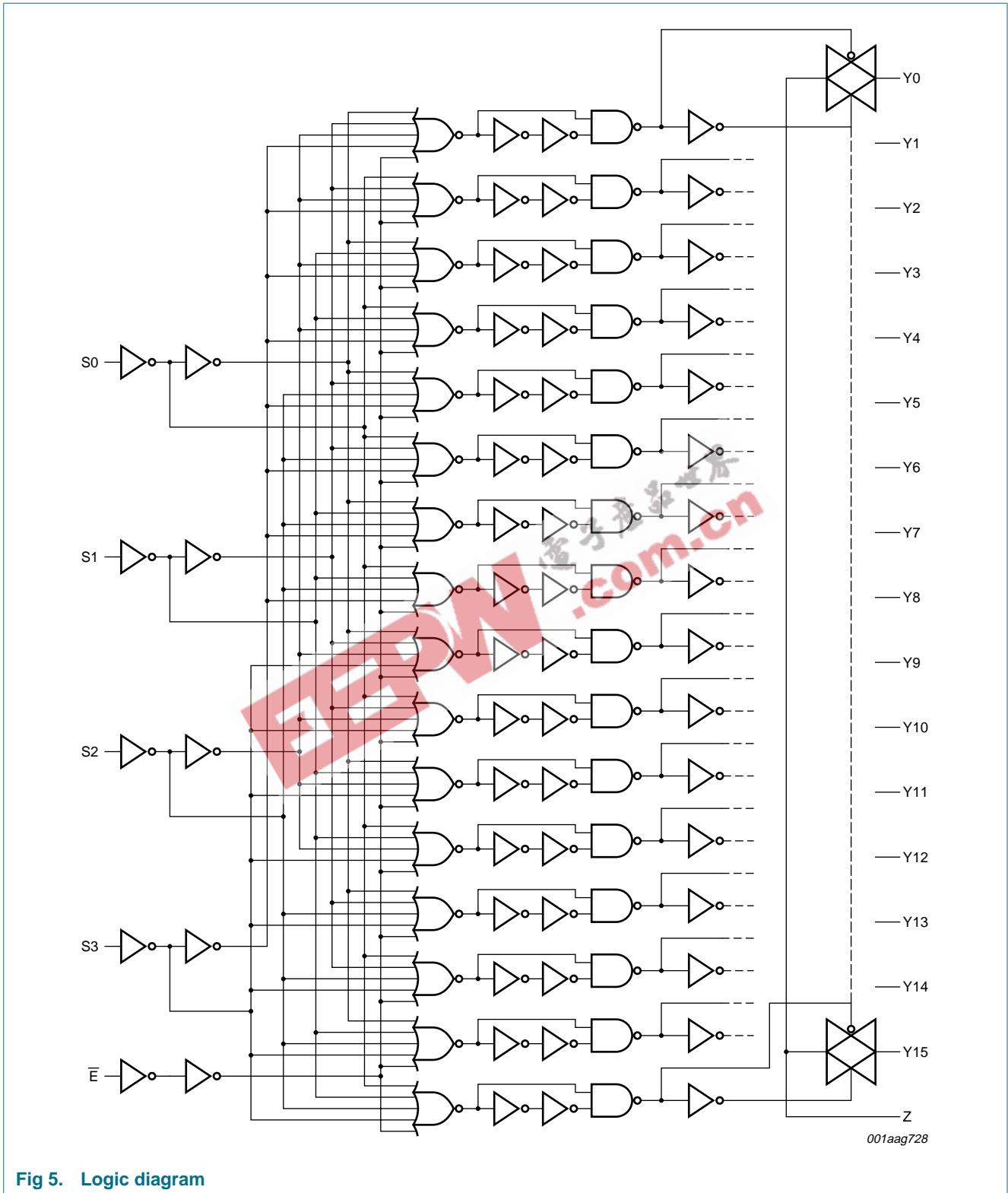
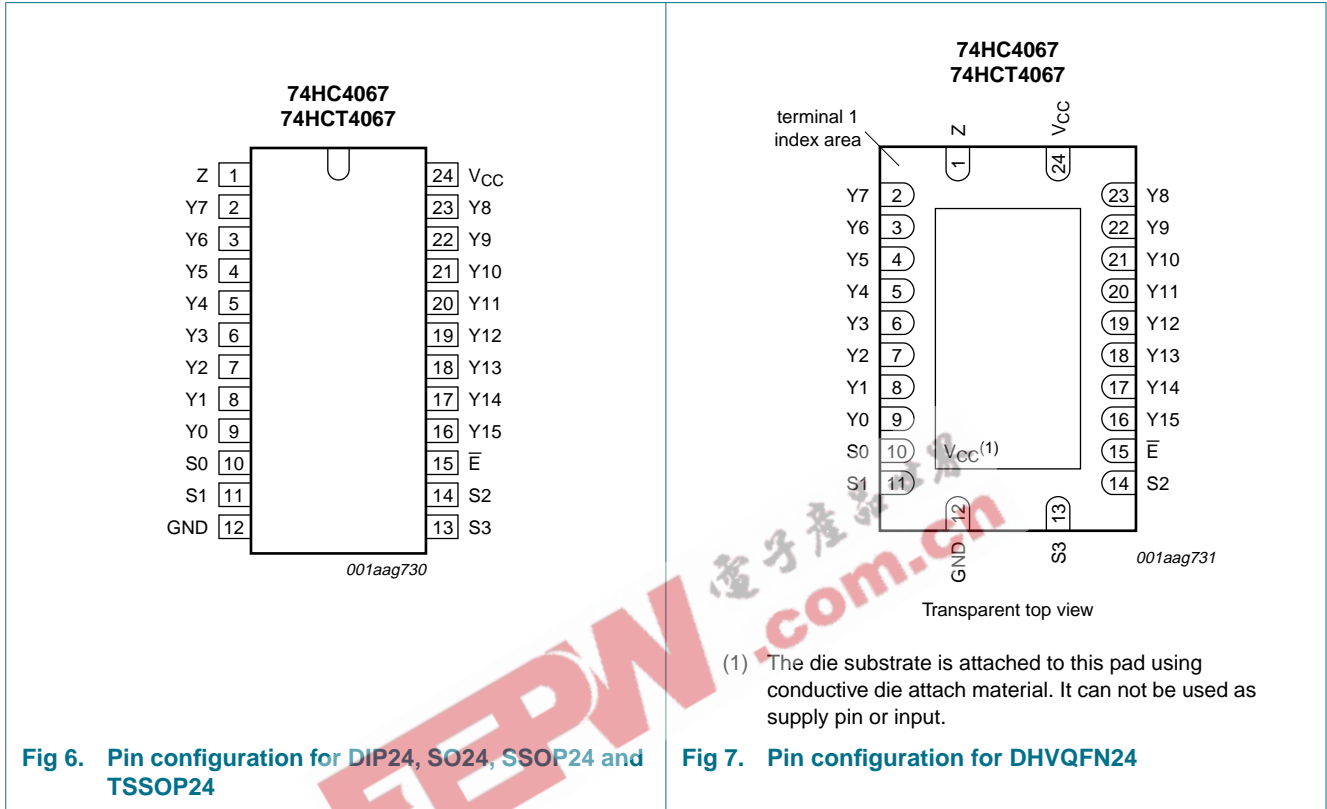

Fig 5. Logic diagram

6. Pinning information

6.1 Pinning



6.2 Pin description

Table 2. Pin description

Symbol	Pin	Description
Z	1	common input/output
Y7	2	independent input/output 7
Y6	3	independent input/output 6
Y5	4	independent input/output 5
Y4	5	independent input/output 4
Y3	6	independent input/output 3
Y2	7	independent input/output 2
Y1	8	independent input/output 1
Y0	9	independent input/output 0
S0	10	address input 0
S1	11	address input 1
GND	12	ground (0 V)
S3	13	address input 3
S2	14	address input 2

Table 2. Pin description ...continued

Symbol	Pin	Description
$\bar{E}$	15	enable input (active LOW)
Y15	16	independent input/output 15
Y14	17	independent input/output 14
Y13	18	independent input/output 13
Y12	19	independent input/output 12
Y11	20	independent input/output 11
Y10	21	independent input/output 10
Y9	22	independent input/output 9
Y8	23	independent input/output 8
V <sub>CC</sub>	24	supply voltage

## 7. Functional description

Table 3. Function table<sup>[1]</sup>

Inputs					Channel ON
$\bar{E}$	S3	S2	S1	S0	
L	L	L	L	L	Y0 to Z
L	L	L	L	H	Y1 to Z
L	L	L	H	L	Y2 to Z
L	L	L	H	H	Y3 to Z
L	L	H	L	L	Y4 to Z
L	L	H	L	H	Y5 to Z
L	L	H	H	L	Y6 to Z
L	L	H	H	H	Y7 to Z
L	H	L	L	L	Y8 to Z
L	H	L	L	H	Y9 to Z
L	H	L	H	L	Y10 to Z
L	H	L	H	H	Y11 to Z
L	H	H	L	L	Y12 to Z
L	H	H	L	H	Y13 to Z
L	H	H	H	L	Y14 to Z
L	H	H	H	H	Y15 to Z
H	X	X	X	X	-

[1] H = HIGH voltage level;  
 L = LOW voltage level;  
 X = don't care.

## 8. Limiting values

**Table 4. Limiting values**

In accordance with the Absolute Maximum Rating System (IEC 60134). Voltages are referenced to GND (ground = 0 V).

Symbol	Parameter	Conditions	Min	Max	Unit
$V_{CC}$	supply voltage		[1] -0.5	+11.0	V
$I_{IK}$	input clamping current	$V_I < -0.5\text{ V}$ or $V_I > V_{CC} + 0.5\text{ V}$	-	$\pm 20$	mA
$I_{SK}$	switch clamping current	$V_{SW} < -0.5\text{ V}$ or $V_{SW} > V_{CC} + 0.5\text{ V}$	-	$\pm 20$	mA
$I_{SW}$	switch current	$V_{SW} = -0.5\text{ V}$ to $(V_{CC} + 0.5\text{ V})$	-	$\pm 25$	mA
$I_{CC}$	supply current		-	50	mA
$I_{GND}$	ground current		-	-50	mA
$T_{stg}$	storage temperature		-65	+150	°C
$P_{tot}$	total power dissipation	$T_{amb} = -40\text{ °C}$ to $+125\text{ °C}$			
		DIP24 package	[2] -	750	mW
		SO24 package	[3] -	500	mW
		SSOP24 package	[4] -	500	mW
		TSSOP24 package	[4] -	500	mW
		DHVQFN24 package	[5] -	500	mW
P	power dissipation	per switch	-	100	mW

- [1] To avoid drawing  $V_{CC}$  current out of terminal Z, when switch current flows in terminals  $Y_n$ , the voltage drop across the bidirectional switch must not exceed 0.4 V. If the switch current flows into terminal Z, no  $V_{CC}$  current will flow out of terminals  $Y_n$ . In this case there is no limit for the voltage drop across the switch, but the voltages at  $Y_n$  and Z may not exceed  $V_{CC}$  or GND.
- [2] For DIP24 package:  $P_{tot}$  derates linearly with 12 mW/K above 70 °C.
- [3] For SO24 package:  $P_{tot}$  derates linearly with 8 mW/K above 70 °C.
- [4] For SSOP24 and TSSOP24 packages:  $P_{tot}$  derates linearly with 5.5 mW/K above 60 °C.
- [5] For DHVQFN24 package:  $P_{tot}$  derates linearly with 4.5 mW/K above 60 °C.

## 9. Recommended operating conditions

**Table 5. Recommended operating conditions**

Symbol	Parameter	Conditions	Min	Typ	Max	Unit
<b>74HC4067</b>						
$V_{CC}$	supply voltage		2.0	5.0	10.0	V
$V_I$	input voltage		GND	-	$V_{CC}$	V
$V_{SW}$	switch voltage		GND	-	$V_{CC}$	V
$t_r$	rise time	$V_{CC} = 2.0\text{ V}$	-	-	1000	ns
		$V_{CC} = 4.5\text{ V}$	-	6.0	500	ns
		$V_{CC} = 6.0\text{ V}$	-	-	400	ns
		$V_{CC} = 10.0\text{ V}$	-	-	250	ns
$t_f$	fall time	$V_{CC} = 2.0\text{ V}$	-	-	1000	ns
		$V_{CC} = 4.5\text{ V}$	-	6.0	500	ns
		$V_{CC} = 6.0\text{ V}$	-	-	400	ns
		$V_{CC} = 10.0\text{ V}$	-	-	250	ns
$T_{amb}$	ambient temperature		-40	+25	+125	°C



Table 5. Recommended operating conditions ...continued

Symbol	Parameter	Conditions	Min	Typ	Max	Unit
<b>74HCT4067</b>						
V <sub>CC</sub>	supply voltage		4.5	5.0	5.5	V
V <sub>I</sub>	input voltage		GND	-	V <sub>CC</sub>	V
V <sub>SW</sub>	switch voltage		GND	-	V <sub>CC</sub>	V
t <sub>r</sub>	rise time	V <sub>CC</sub> = 4.5 V	-	6.0	500	ns
t <sub>f</sub>	fall time	V <sub>CC</sub> = 4.5 V	-	6.0	500	ns
T <sub>amb</sub>	ambient temperature		-40	+25	+125	°C

## 10. Static characteristics

Table 6. R<sub>ON</sub> resistance per switch for types 74HC4067 and 74HCT4067

V<sub>I</sub> = V<sub>IH</sub> or V<sub>IL</sub>; for test circuit see Figure 8.

V<sub>is</sub> is the input voltage at a Yn or Z terminal, whichever is assigned as an input.

V<sub>os</sub> is the output voltage at a Yn or Z terminal, whichever is assigned as an output.

For 74HC4067: V<sub>CC</sub> – GND = 2.0 V, 4.5 V, 6.0 V and 9.0 V.

For 74HCT4067: V<sub>CC</sub> – GND = 4.5 V.

Symbol	Parameter	Conditions	25 °C		–40 °C to +125 °C		Unit	
			Typ	Max	Max (85 °C)	Max (125 °C)		
R <sub>ON(peak)</sub>	ON resistance (peak)	V <sub>is</sub> = V <sub>CC</sub> to GND						
		V <sub>CC</sub> = 2.0 V; I <sub>SW</sub> = 100 µA	[1]	-	-	-	Ω	
		V <sub>CC</sub> = 4.5 V; I <sub>SW</sub> = 1000 µA		110	180	225	270	Ω
		V <sub>CC</sub> = 6.0 V; I <sub>SW</sub> = 1000 µA		95	160	200	240	Ω
R <sub>ON(rail)</sub>	ON resistance (rail)	V <sub>is</sub> = GND or V <sub>CC</sub>						
		V <sub>CC</sub> = 2.0 V; I <sub>SW</sub> = 100 µA	[1]	150	-	-	-	
		V <sub>CC</sub> = 4.5 V; I <sub>SW</sub> = 1000 µA		90	160	200	240	Ω
		V <sub>CC</sub> = 6.0 V; I <sub>SW</sub> = 1000 µA		80	140	175	210	Ω
ΔR <sub>ON</sub>	ON resistance mismatch between channels	V <sub>is</sub> = V <sub>CC</sub> to GND						
		V <sub>CC</sub> = 2.0 V	[1]	-	-	-	Ω	
		V <sub>CC</sub> = 4.5 V		9	-	-	Ω	
		V <sub>CC</sub> = 6.0 V		8	-	-	Ω	
		V <sub>CC</sub> = 9.0 V		6	-	-	Ω	

[1] At supply voltages (V<sub>CC</sub> – GND) approaching 2 V, the analog switch ON resistance becomes extremely non-linear. Therefore it is recommended that these devices be used to transmit digital signals only, when using these supply voltages.

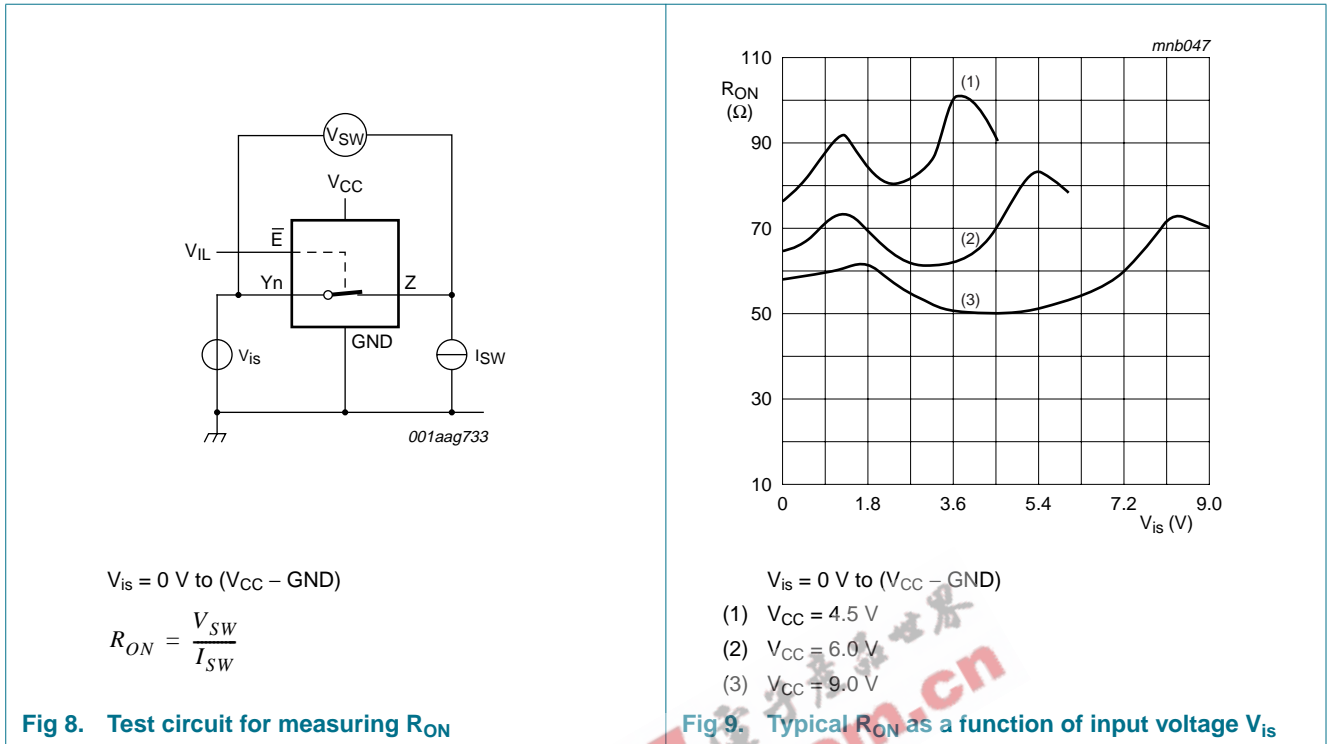

**Table 7. Static characteristics 74HC4067**

At recommended operating conditions; voltages are referenced to GND (ground = 0 V).  
 $V_{is}$  is the input voltage at a Yn or Z terminal, whichever is assigned as an input.  
 $V_{os}$  is the output voltage at a Yn or Z terminal, whichever is assigned as an output.

Symbol	Parameter	Conditions	Min	Typ	Max	Unit
<b><math>T_{amb} = 25 \text{ }^\circ\text{C}</math></b>						
$V_{IH}$	HIGH-level input voltage	$V_{CC} = 2.0 \text{ V}$	1.5	1.2	-	V
		$V_{CC} = 4.5 \text{ V}$	3.15	2.4	-	V
		$V_{CC} = 6.0 \text{ V}$	4.2	3.2	-	V
		$V_{CC} = 9.0 \text{ V}$	6.3	4.7	-	V
$V_{IL}$	LOW-level input voltage	$V_{CC} = 2.0 \text{ V}$	-	0.8	0.5	V
		$V_{CC} = 4.5 \text{ V}$	-	2.1	1.35	V
		$V_{CC} = 6.0 \text{ V}$	-	2.8	1.80	V
		$V_{CC} = 9.0 \text{ V}$	-	4.3	2.70	V
$I_I$	input leakage current	$V_I = V_{CC} \text{ or } \text{GND}$				
		$V_{CC} = 6.0 \text{ V}$	-	-	$\pm 0.1$	$\mu\text{A}$
		$V_{CC} = 10.0 \text{ V}$	-	-	$\pm 0.2$	$\mu\text{A}$
$I_{S(\text{OFF})}$	OFF-state leakage current	$V_{CC} = 10.0 \text{ V}; V_I = V_{IH} \text{ or } V_{IL};  V_{SW}  = V_{CC} - \text{GND};$ see <a href="#">Figure 10</a>				
		per channel	-	-	$\pm 0.1$	$\mu\text{A}$
		all channels	-	-	$\pm 0.8$	$\mu\text{A}$
$I_{S(\text{ON})}$	ON-state leakage current	$V_{CC} = 10.0 \text{ V}; V_I = V_{IH} \text{ or } V_{IL};  V_{SW}  = V_{CC} - \text{GND};$ see <a href="#">Figure 11</a>	-	-	$\pm 0.8$	$\mu\text{A}$

**Table 7. Static characteristics 74HC4067 ...continued**

At recommended operating conditions; voltages are referenced to GND (ground = 0 V).

$V_{is}$  is the input voltage at a Yn or Z terminal, whichever is assigned as an input.

$V_{os}$  is the output voltage at a Yn or Z terminal, whichever is assigned as an output.

Symbol	Parameter	Conditions	Min	Typ	Max	Unit
$I_{CC}$	supply current	$V_I = V_{CC}$ or GND; $V_{is} =$ GND or $V_{CC}$ ; $V_{os} = V_{CC}$ or GND				
		$V_{CC} = 6.0$ V	-	-	8.0	$\mu$ A
		$V_{CC} = 10.0$ V	-	-	16.0	$\mu$ A
$C_I$	input capacitance		-	3.5	-	pF
<b><math>T_{amb} = -40</math> °C to <math>+85</math> °C</b>						
$V_{IH}$	HIGH-level input voltage	$V_{CC} = 2.0$ V	1.5	-	-	V
		$V_{CC} = 4.5$ V	3.15	-	-	V
		$V_{CC} = 6.0$ V	4.2	-	-	V
		$V_{CC} = 9.0$ V	6.3	-	-	V
$V_{IL}$	LOW-level input voltage	$V_{CC} = 2.0$ V	-	-	0.50	V
		$V_{CC} = 4.5$ V	-	-	1.35	V
		$V_{CC} = 6.0$ V	-	-	1.80	V
		$V_{CC} = 9.0$ V	-	-	2.70	V
$I_I$	input leakage current	$V_I = V_{CC}$ or GND				
		$V_{CC} = 6.0$ V	-	-	$\pm 1.0$	$\mu$ A
		$V_{CC} = 10.0$ V	-	-	$\pm 2.0$	$\mu$ A
$I_{S(OFF)}$	OFF-state leakage current	$V_{CC} = 10.0$ V; $V_I = V_{IH}$ or $V_{IL}$ ; $ V_{SW}  = V_{CC} -$ GND; see <a href="#">Figure 10</a>				
		per channel	-	-	$\pm 1.0$	$\mu$ A
		all channels	-	-	$\pm 8.0$	$\mu$ A
$I_{S(ON)}$	ON-state leakage current	$V_{CC} = 10.0$ V; $V_I = V_{IH}$ or $V_{IL}$ ; $ V_{SW}  = V_{CC} -$ GND; see <a href="#">Figure 11</a>	-	-	$\pm 8.0$	$\mu$ A
$I_{CC}$	supply current	$V_I = V_{CC}$ or GND; $V_{is} =$ GND or $V_{CC}$ ; $V_{os} = V_{CC}$ or GND				
		$V_{CC} = 6.0$ V	-	-	80.0	$\mu$ A
		$V_{CC} = 10.0$ V	-	-	160	$\mu$ A
<b><math>T_{amb} = -40</math> °C to <math>+125</math> °C</b>						
$V_{IH}$	HIGH-level input voltage	$V_{CC} = 2.0$ V	1.5	-	-	V
		$V_{CC} = 4.5$ V	3.15	-	-	V
		$V_{CC} = 6.0$ V	4.2	-	-	V
		$V_{CC} = 9.0$ V	6.3	-	-	V
$V_{IL}$	LOW-level input voltage	$V_{CC} = 2.0$ V	-	-	0.50	V
		$V_{CC} = 4.5$ V	-	-	1.35	V
		$V_{CC} = 6.0$ V	-	-	1.80	V
		$V_{CC} = 9.0$ V	-	-	2.70	V
$I_I$	input leakage current	$V_I = V_{CC}$ or GND				
		$V_{CC} = 6.0$ V	-	-	$\pm 1.0$	$\mu$ A
		$V_{CC} = 10.0$ V	-	-	$\pm 2.0$	$\mu$ A

**Table 7. Static characteristics 74HC4067 ...continued**

At recommended operating conditions; voltages are referenced to GND (ground = 0 V).

$V_{is}$  is the input voltage at a Yn or Z terminal, whichever is assigned as an input.

$V_{os}$  is the output voltage at a Yn or Z terminal, whichever is assigned as an output.

Symbol	Parameter	Conditions	Min	Typ	Max	Unit
$I_{S(OFF)}$	OFF-state leakage current	$V_{CC} = 10.0\text{ V}$ ; $V_I = V_{IH}$ or $V_{IL}$ ; $ V_{SW}  = V_{CC} - \text{GND}$ ; see <a href="#">Figure 10</a>				
		per channel	-	-	$\pm 1.0$	$\mu\text{A}$
		all channels	-	-	$\pm 8.0$	$\mu\text{A}$
$I_{S(ON)}$	ON-state leakage current	$V_{CC} = 10.0\text{ V}$ ; $V_I = V_{IH}$ or $V_{IL}$ ; $ V_{SW}  = V_{CC} - \text{GND}$ ; see <a href="#">Figure 11</a>	-	-	$\pm 8.0$	$\mu\text{A}$
$I_{CC}$	supply current	$V_I = V_{CC}$ or GND; $V_{is} = \text{GND}$ or $V_{CC}$ ; $V_{os} = V_{CC}$ or GND				
		$V_{CC} = 6.0\text{ V}$	-	-	160	$\mu\text{A}$
		$V_{CC} = 10.0\text{ V}$	-	-	320	$\mu\text{A}$

**Table 8. Static characteristics 74HCT4067**

At recommended operating conditions; voltages are referenced to GND (ground = 0 V).

$V_{is}$  is the input voltage at a Yn or Z terminal, whichever is assigned as an input.

$V_{os}$  is the output voltage at a Yn or Z terminal, whichever is assigned as an output.

Symbol	Parameter	Conditions	Min	Typ	Max	Unit
<b><math>T_{amb} = 25\text{ }^\circ\text{C}</math></b>						
$V_{IH}$	HIGH-level input voltage	$V_{CC} = 4.5\text{ V}$ to $5.5\text{ V}$	2.0	1.6	-	V
$V_{IL}$	LOW-level input voltage	$V_{CC} = 4.5\text{ V}$ to $5.5\text{ V}$	-	1.2	0.8	V
$I_I$	input leakage current	$V_I = V_{CC}$ or GND; $V_{CC} = 5.5\text{ V}$	-	-	$\pm 0.1$	$\mu\text{A}$
$I_{S(OFF)}$	OFF-state leakage current	$V_{CC} = 5.5\text{ V}$ ; $V_I = V_{IH}$ or $V_{IL}$ ; $ V_{SW}  = V_{CC} - \text{GND}$ ; see <a href="#">Figure 10</a>				
		per channel	-	-	$\pm 0.1$	$\mu\text{A}$
		all channels	-	-	$\pm 0.8$	$\mu\text{A}$
$I_{S(ON)}$	ON-state leakage current	$V_{CC} = 5.5\text{ V}$ ; $V_I = V_{IH}$ or $V_{IL}$ ; $ V_{SW}  = V_{CC} - \text{GND}$ ; see <a href="#">Figure 11</a>	-	-	$\pm 0.8$	$\mu\text{A}$
$I_{CC}$	supply current	$V_I = V_{CC}$ or GND; $V_{is} = \text{GND}$ or $V_{CC}$ ; $V_{os} = V_{CC}$ or GND; $V_{CC} = 4.5\text{ V}$ to $5.5\text{ V}$	-	-	8.0	$\mu\text{A}$
$\Delta I_{CC}$	additional supply current	per input pin; $V_I = V_{CC} - 2.1\text{ V}$ ; other inputs at $V_{CC}$ or GND; $V_{CC} = 4.5\text{ V}$ to $5.5\text{ V}$				
		pin $\bar{E}$	-	60	216	$\mu\text{A}$
		pin Sn	-	50	180	$\mu\text{A}$
$C_I$	input capacitance		-	3.5	-	pF
<b><math>T_{amb} = -40\text{ }^\circ\text{C}</math> to <math>+85\text{ }^\circ\text{C}</math></b>						
$V_{IH}$	HIGH-level input voltage	$V_{CC} = 4.5\text{ V}$ to $5.5\text{ V}$	2.0	-	-	V
$V_{IL}$	LOW-level input voltage	$V_{CC} = 4.5\text{ V}$ to $5.5\text{ V}$	-	-	0.8	V
$I_I$	input leakage current	$V_I = V_{CC}$ or GND; $V_{CC} = 5.5\text{ V}$	-	-	$\pm 1.0$	$\mu\text{A}$
$I_{S(OFF)}$	OFF-state leakage current	$V_{CC} = 5.5\text{ V}$ ; $V_I = V_{IH}$ or $V_{IL}$ ; $ V_{SW}  = V_{CC} - \text{GND}$ ; see <a href="#">Figure 10</a>				
		per channel	-	-	$\pm 1.0$	$\mu\text{A}$
		all channels	-	-	$\pm 8.0$	$\mu\text{A}$

**Table 8. Static characteristics 74HCT4067 ...continued**

At recommended operating conditions; voltages are referenced to GND (ground = 0 V).

$V_{is}$  is the input voltage at a  $Y_n$  or  $Z$  terminal, whichever is assigned as an input.

$V_{os}$  is the output voltage at a  $Y_n$  or  $Z$  terminal, whichever is assigned as an output.

Symbol	Parameter	Conditions	Min	Typ	Max	Unit
$I_{S(ON)}$	ON-state leakage current	$V_{CC} = 5.5\text{ V}$ ; $V_I = V_{IH}$ or $V_{IL}$ ; $ V_{SW}  = V_{CC} - \text{GND}$ ; see <a href="#">Figure 11</a>	-	-	$\pm 8.0$	$\mu\text{A}$
$I_{CC}$	supply current	$V_I = V_{CC}$ or $\text{GND}$ ; $V_{is} = \text{GND}$ or $V_{CC}$ ; $V_{os} = V_{CC}$ or $\text{GND}$ ; $V_{CC} = 4.5\text{ V}$ to $5.5\text{ V}$	-	-	80.0	$\mu\text{A}$
$\Delta I_{CC}$	additional supply current	per input pin; $V_I = V_{CC} - 2.1\text{ V}$ ; other inputs at $V_{CC}$ or $\text{GND}$ ; $V_{CC} = 4.5\text{ V}$ to $5.5\text{ V}$				
		pin $\bar{E}$	-	-	270	$\mu\text{A}$
		pin Sn	-	-	225	$\mu\text{A}$
<b><math>T_{amb} = -40\text{ }^\circ\text{C}</math> to <math>+125\text{ }^\circ\text{C}</math></b>						
$V_{IH}$	HIGH-level input voltage	$V_{CC} = 4.5\text{ V}$ to $5.5\text{ V}$	2.0	-	-	V
$V_{IL}$	LOW-level input voltage	$V_{CC} = 4.5\text{ V}$ to $5.5\text{ V}$	-	-	0.8	V
$I_I$	input leakage current	$V_I = V_{CC}$ or $\text{GND}$ ; $V_{CC} = 5.5\text{ V}$	-	-	$\pm 1.0$	$\mu\text{A}$
$I_{S(OFF)}$	OFF-state leakage current	$V_{CC} = 5.5\text{ V}$ ; $V_I = V_{IH}$ or $V_{IL}$ ; $ V_{SW}  = V_{CC} - \text{GND}$ ; see <a href="#">Figure 10</a>				
		per channel	-	-	$\pm 1.0$	$\mu\text{A}$
		all channels	-	-	$\pm 8.0$	$\mu\text{A}$
$I_{S(ON)}$	ON-state leakage current	$V_{CC} = 5.5\text{ V}$ ; $V_I = V_{IH}$ or $V_{IL}$ ; $ V_{SW}  = V_{CC} - \text{GND}$ ; see <a href="#">Figure 11</a>	-	-	$\pm 8.0$	$\mu\text{A}$
$I_{CC}$	supply current	$V_I = V_{CC}$ or $\text{GND}$ ; $V_{is} = \text{GND}$ or $V_{CC}$ ; $V_{os} = V_{CC}$ or $\text{GND}$ ; $V_{CC} = 4.5\text{ V}$ to $5.5\text{ V}$	-	-	160	$\mu\text{A}$
$\Delta I_{CC}$	additional supply current	per input pin; $V_I = V_{CC} - 2.1\text{ V}$ ; other inputs at $V_{CC}$ or $\text{GND}$ ; $V_{CC} = 4.5\text{ V}$ to $5.5\text{ V}$				
		pin $\bar{E}$	-	-	294	$\mu\text{A}$
		pin Sn	-	-	245	$\mu\text{A}$

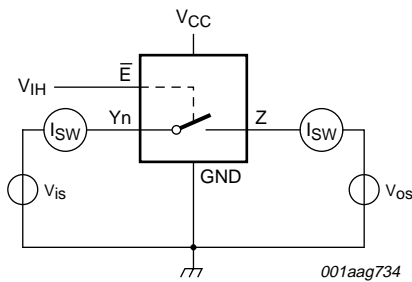

$V_{is} = V_{CC}$  and  $V_{os} = \text{GND}$   
 $V_{is} = \text{GND}$  and  $V_{os} = V_{CC}$

**Fig 10. Test circuit for measuring OFF-state leakage current**

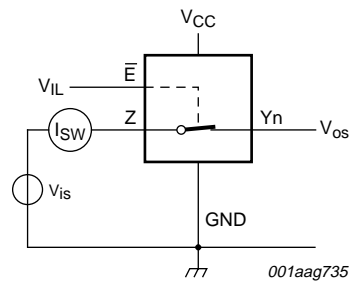

$V_{is} = V_{CC}$  and  $V_{os} = \text{open}$   
 $V_{is} = \text{GND}$  and  $V_{os} = \text{open}$

**Fig 11. Test circuit for measuring ON-state leakage current**

## 11. Dynamic characteristics

**Table 9. Dynamic characteristics 74HC4067**

$GND = 0\text{ V}$ ;  $t_r = t_f = 6\text{ ns}$ ;  $C_L = 50\text{ pF}$  unless specified otherwise; for test circuit see [Figure 14](#).

$V_{is}$  is the input voltage at a  $Y_n$  or  $Z$  terminal, whichever is assigned as an input.

$V_{os}$  is the output voltage at a  $Y_n$  or  $Z$  terminal, whichever is assigned as an output.

Symbol	Parameter	Conditions	25 °C		-40 °C to +125 °C		Unit		
			Typ	Max	Max (85 °C)	Max (125 °C)			
$t_{pd}$	propagation delay	Yn to Z; see <a href="#">Figure 12</a> <span style="float:right">[1][2]</span>							
		$V_{CC} = 2.0\text{ V}$	25	75	95	110	ns		
		$V_{CC} = 4.5\text{ V}$	9	15	19	22	ns		
		$V_{CC} = 6.0\text{ V}$	7	13	16	19	ns		
		$V_{CC} = 9.0\text{ V}$	5	9	11	14	ns		
		Z to Yn							
		$V_{CC} = 2.0\text{ V}$	18	60	75	90	ns		
		$V_{CC} = 4.5\text{ V}$	6	12	15	18	ns		
		$V_{CC} = 6.0\text{ V}$	5	10	13	15	ns		
		$V_{CC} = 9.0\text{ V}$	4	8	10	12	ns		
		$t_{off}$	turn-off time	$\bar{E}$ to Yn; see <a href="#">Figure 13</a> <span style="float:right">[3]</span>					
				$V_{CC} = 2.0\text{ V}$	74	250	315	375	ns
				$V_{CC} = 4.5\text{ V}$	27	50	63	75	ns
				$V_{CC} = 5.0\text{ V}$ ; $C_L = 15\text{ pF}$	27	-	-	-	ns
$V_{CC} = 6.0\text{ V}$	22			43	54	64	ns		
$V_{CC} = 9.0\text{ V}$	20			38	48	57	ns		
Sn to Yn									
$V_{CC} = 2.0\text{ V}$	83			250	315	375	ns		
$V_{CC} = 4.5\text{ V}$	30			50	63	75	ns		
$V_{CC} = 5.0\text{ V}$ ; $C_L = 15\text{ pF}$	29			-	-	-	ns		
$V_{CC} = 6.0\text{ V}$	24			43	54	64	ns		
$V_{CC} = 9.0\text{ V}$	21			38	48	57	ns		
$\bar{E}$ to Z									
$V_{CC} = 2.0\text{ V}$	85			275	345	415	ns		
$V_{CC} = 4.5\text{ V}$	31			55	69	83	ns		
$V_{CC} = 6.0\text{ V}$	25			47	59	71	ns		
$V_{CC} = 9.0\text{ V}$	24			42	53	63	ns		
Sn to Z									
$V_{CC} = 2.0\text{ V}$	94			290	365	435	ns		
$V_{CC} = 4.5\text{ V}$	34			58	73	87	ns		
$V_{CC} = 6.0\text{ V}$	27			47	62	74	ns		
$V_{CC} = 9.0\text{ V}$	25			45	56	68	ns		

**Table 9. Dynamic characteristics 74HC4067 ...continued**

$GND = 0\text{ V}$ ;  $t_r = t_f = 6\text{ ns}$ ;  $C_L = 50\text{ pF}$  unless specified otherwise; for test circuit see [Figure 14](#).

$V_{is}$  is the input voltage at a Yn or Z terminal, whichever is assigned as an input.

$V_{os}$  is the output voltage at a Yn or Z terminal, whichever is assigned as an output.

Symbol	Parameter	Conditions	25 °C		-40 °C to +125 °C		Unit		
			Typ	Max	Max (85 °C)	Max (125 °C)			
$t_{on}$	turn-on time	$\bar{E}$ to Yn; see <a href="#">Figure 13</a>	<a href="#">[4]</a>						
		$V_{CC} = 2.0\text{ V}$	80	275	345	415	ns		
		$V_{CC} = 4.5\text{ V}$	29	55	69	83	ns		
		$V_{CC} = 5.0\text{ V}$ ; $C_L = 15\text{ pF}$	26	-	-	-	ns		
		$V_{CC} = 6.0\text{ V}$	23	47	59	71	ns		
		$V_{CC} = 9.0\text{ V}$	17	42	53	63	ns		
		Sn to Yn							
		$V_{CC} = 2.0\text{ V}$	88	300	375	450	ns		
		$V_{CC} = 4.5\text{ V}$	32	60	75	90	ns		
		$V_{CC} = 5.0\text{ V}$ ; $C_L = 15\text{ pF}$	29	-	-	-	ns		
		$V_{CC} = 6.0\text{ V}$	26	51	64	77	ns		
		$V_{CC} = 9.0\text{ V}$	18	45	56	68	ns		
		$\bar{E}$ to Z							
		$V_{CC} = 2.0\text{ V}$	85	275	345	415	ns		
		$V_{CC} = 4.5\text{ V}$	31	55	69	83	ns		
		$V_{CC} = 6.0\text{ V}$	25	47	59	71	ns		
		$V_{CC} = 9.0\text{ V}$	18	42	53	63	ns		
		Sn to Z							
		$V_{CC} = 2.0\text{ V}$	94	300	375	450	ns		
		$V_{CC} = 4.5\text{ V}$	34	60	75	90	ns		
		$V_{CC} = 6.0\text{ V}$	27	51	64	77	ns		
$V_{CC} = 9.0\text{ V}$	19	45	56	68	ns				
$C_{PD}$	power dissipation capacitance	per switch; $V_I = GND$ to $V_{CC}$	<a href="#">[5]</a>		-	29	-	-	pF

[1]  $t_{pd}$  is the same as  $t_{PHL}$  and  $t_{PLH}$ .

[2] Due to higher Z terminal capacitance (16 switches versus 1) the delay figures to the Z terminal are higher than those to the Y terminal.

[3]  $t_{on}$  is the same as  $t_{PHZ}$  and  $t_{PLZ}$ .

[4]  $t_{off}$  is the same as  $t_{PZH}$  and  $t_{PZL}$ .

[5]  $C_{PD}$  is used to determine the dynamic power dissipation ( $P_D$  in  $\mu\text{W}$ ).

$$P_D = C_{PD} \times V_{CC}^2 \times f_i + \sum\{(C_L + C_{sw}) \times V_{CC}^2 \times f_o\}$$
 where:

$f_i$  = input frequency in MHz;

$f_o$  = output frequency in MHz;

$\sum\{(C_L + C_{sw}) \times V_{CC}^2 \times f_o\}$  = sum of outputs;

$C_L$  = output load capacitance in pF;

$C_{sw}$  = switch capacitance in pF;

$V_{CC}$  = supply voltage in V.

**Table 10. Dynamic characteristics 74HCT4067**

$GND = 0\text{ V}$ ;  $t_r = t_f = 6\text{ ns}$ ;  $C_L = 50\text{ pF}$  unless specified otherwise; for test circuit see [Figure 14](#).

$V_{is}$  is the input voltage at a Yn or Z terminal, whichever is assigned as an input.

$V_{os}$  is the output voltage at a Yn or Z terminal, whichever is assigned as an output.

Symbol	Parameter	Conditions	25 °C		-40 °C to +125 °C		Unit
			Typ	Max	Max (85 °C)	Max (125 °C)	
$t_{pd}$	propagation delay	Yn to Z; see <a href="#">Figure 12</a> <span style="float:right">[1][2]</span>					
		$V_{CC} = 4.5\text{ V}$	9	15	19	22	ns
		Z to Yn					
		$V_{CC} = 4.5\text{ V}$	6	12	15	18	ns
$t_{off}$	turn-off time	$\bar{E}$ to Yn; see <a href="#">Figure 13</a> <span style="float:right">[3]</span>					
		$V_{CC} = 4.5\text{ V}$	26	55	69	83	ns
		$V_{CC} = 5.0\text{ V}$ ; $C_L = 15\text{ pF}$	26	-	-	-	ns
		Sn to Yn					
		$V_{CC} = 4.5\text{ V}$	31	55	69	83	ns
		$V_{CC} = 5.0\text{ V}$ ; $C_L = 15\text{ pF}$	30	-	-	-	ns
		$\bar{E}$ to Z					
		$V_{CC} = 4.5\text{ V}$	30	60	75	90	ns
		Sn to Z					
		$V_{CC} = 4.5\text{ V}$	35	60	75	90	ns
$t_{on}$	turn-on time	$\bar{E}$ to Yn; see <a href="#">Figure 13</a> <span style="float:right">[4]</span>					
		$V_{CC} = 4.5\text{ V}$	32	60	75	90	ns
		$V_{CC} = 5.0\text{ V}$ ; $C_L = 15\text{ pF}$	32	-	-	-	ns
		Sn to Yn					
		$V_{CC} = 4.5\text{ V}$	35	60	75	90	ns
		$V_{CC} = 5.0\text{ V}$ ; $C_L = 15\text{ pF}$	33	-	-	-	ns
		$\bar{E}$ to Z					
		$V_{CC} = 4.5\text{ V}$	38	65	81	98	ns
		Sn to Z					
		$V_{CC} = 4.5\text{ V}$	38	65	81	98	ns
$C_{PD}$	power dissipation capacitance	per switch; $V_I = GND$ to $(V_{CC} - 1.5\text{ V})$ <span style="float:right">[5]</span>	-	29	-	-	pF

[1]  $t_{pd}$  is the same as  $t_{PHL}$  and  $t_{PLH}$ .

[2] Due to higher Z terminal capacitance (16 switches versus 1) the delay figures to the Z terminal are higher than those to the Y terminal.

[3]  $t_{on}$  is the same as  $t_{PHZ}$  and  $t_{PLZ}$ .

[4]  $t_{off}$  is the same as  $t_{PZH}$  and  $t_{PZL}$ .

[5]  $C_{PD}$  is used to determine the dynamic power dissipation ( $P_D$  in  $\mu\text{W}$ ).

$$P_D = C_{PD} \times V_{CC}^2 \times f_i + \sum\{(C_L + C_{sw}) \times V_{CC}^2 \times f_o\}$$

where:

$f_i$  = input frequency in MHz;

$f_o$  = output frequency in MHz;

$\sum\{(C_L + C_{sw}) \times V_{CC}^2 \times f_o\}$  = sum of outputs;

$C_L$  = output load capacitance in pF;

$C_{sw}$  = switch capacitance in pF;

$V_{CC}$  = supply voltage in V.



12. Waveforms

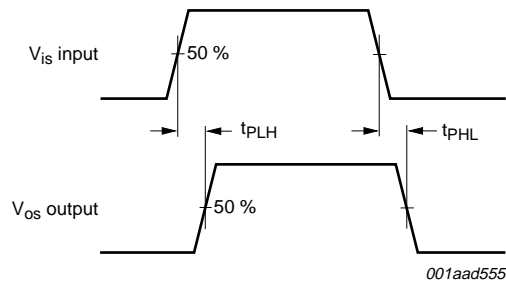
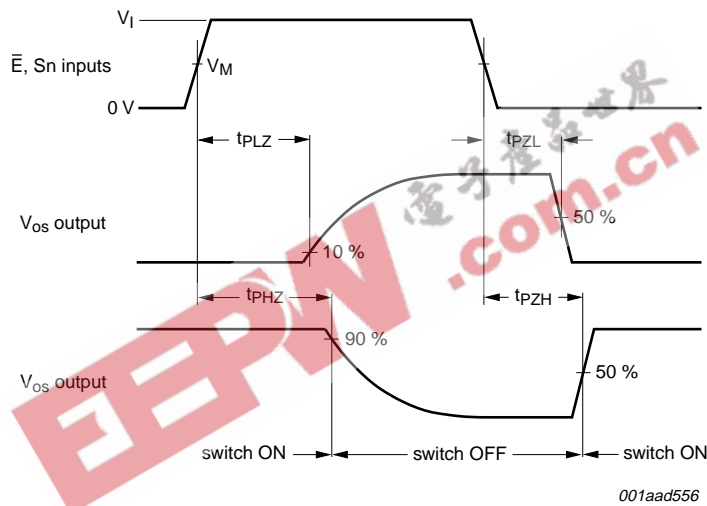

Fig 12. Input ( $V_{is}$ ) to output ( $V_{os}$ ) propagation delays



Measurement points are shown in [Table 11](#).

Fig 13. Turn-on and turn-off times

Table 11. Measurement points

Type	$V_I$	$V_M$
74HC4067	$V_{CC}$	$0.5V_{CC}$
74HCT4067	3.0 V	1.3 V

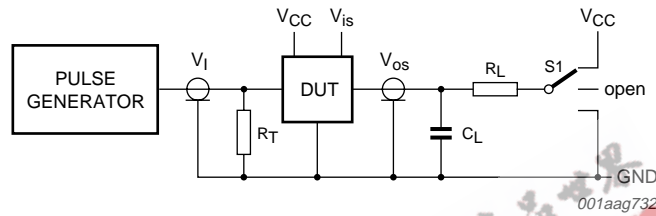
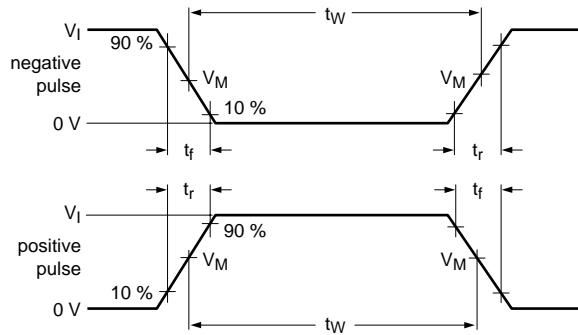

Test data is given in [Table 12](#).

Definitions test circuit:

$R_T$  = Termination resistance should be equal to output impedance  $Z_o$  of the pulse generator.

$C_L$  = Load capacitance including jig and probe capacitance.

$R_L$  = Load resistor.

S1 = Test selection switch.

Fig 14. Load circuitry for measuring switching times

Table 12. Test data

Test	Input				Output		S1 position
	Control $\bar{E}$	Address Sn	Switch Yn (Z)	$t_r, t_f$	Switch Z (Yn)		
	$V_I$ [1]	$V_I$ [1]	$V_{is}$		$C_L$	$R_L$	
$t_{PHL}, t_{PLH}$	GND	GND or $V_{CC}$	GND to $V_{CC}$	6 ns	50 pF	-	open
$t_{PHZ}, t_{PZH}$	GND to $V_{CC}$	GND to $V_{CC}$	$V_{CC}$	6 ns	50 pF, 15 pF	1 k $\Omega$	GND
$t_{PLZ}, t_{PZL}$	GND to $V_{CC}$	GND to $V_{CC}$	GND	6 ns	50 pF, 15 pF	1 k $\Omega$	$V_{CC}$

[1] For 74HCT4067: maximum input voltage  $V_I = 3.0$  V.

### 13. Additional dynamic characteristics

**Table 13. Additional dynamic characteristics**

Recommended conditions and typical values;  $GND = 0\text{ V}$ ;  $T_{amb} = 25\text{ }^\circ\text{C}$ .

$V_{is}$  is the input voltage at a  $Y_n$  or  $Z$  terminal, whichever is assigned as an input.

$V_{os}$  is the output voltage at a  $Y_n$  or  $Z$  terminal, whichever is assigned as an output.

Symbol	Parameter	Conditions	Min	Typ	Max	Unit
THD	total harmonic distortion	$R_L = 10\text{ k}\Omega$ ; $C_L = 50\text{ pF}$ ; see <a href="#">Figure 15</a>				
		$f_i = 1\text{ kHz}$				
		$V_{CC} = 4.5\text{ V}$ ; $V_{is(p-p)} = 4.0\text{ V}$	-	0.04	-	%
		$V_{CC} = 9.0\text{ V}$ ; $V_{is(p-p)} = 8.0\text{ V}$	-	0.02	-	%
		$f_i = 10\text{ kHz}$				
		$V_{CC} = 4.5\text{ V}$ ; $V_{is(p-p)} = 4.0\text{ V}$	-	0.12	-	%
$\alpha_{iso}$	isolation (OFF-state)	$R_L = 600\text{ }\Omega$ ; $C_L = 50\text{ pF}$ ; see <a href="#">Figure 16</a>	[1]			
		$V_{CC} = 4.5\text{ V}$	-	-50	-	dB
		$V_{CC} = 9.0\text{ V}$	-	-50	-	dB
$f_{(-3dB)}$	-3 dB frequency response	$R_L = 50\text{ }\Omega$ ; $C_L = 10\text{ pF}$ ; see <a href="#">Figure 17</a>	[2]			
		$V_{CC} = 4.5\text{ V}$	-	90	-	MHz
		$V_{CC} = 9.0\text{ V}$	-	100	-	MHz
$C_{sw}$	switch capacitance	independent pins Y	-	5	-	pF
		common pin Z	-	45	-	pF

[1] Adjust input voltage  $V_{is}$  to 0 dBm level ( $0\text{ dBm} = 1\text{ mW}$  into  $600\text{ }\Omega$ ).

[2] Adjust input voltage  $V_{is}$  to 0 dBm level at  $V_{os}$  for  $f_i = 1\text{ MHz}$  ( $0\text{ dBm} = 1\text{ mW}$  into  $50\text{ }\Omega$ ). After set-up,  $f_i$  is increased to obtain a reading of -3 dB at  $V_{os}$ .

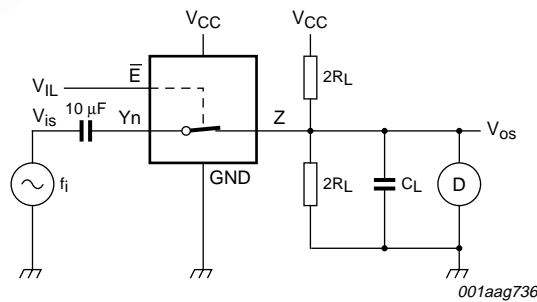

**Fig 15. Test circuit for measuring total harmonic distortion**

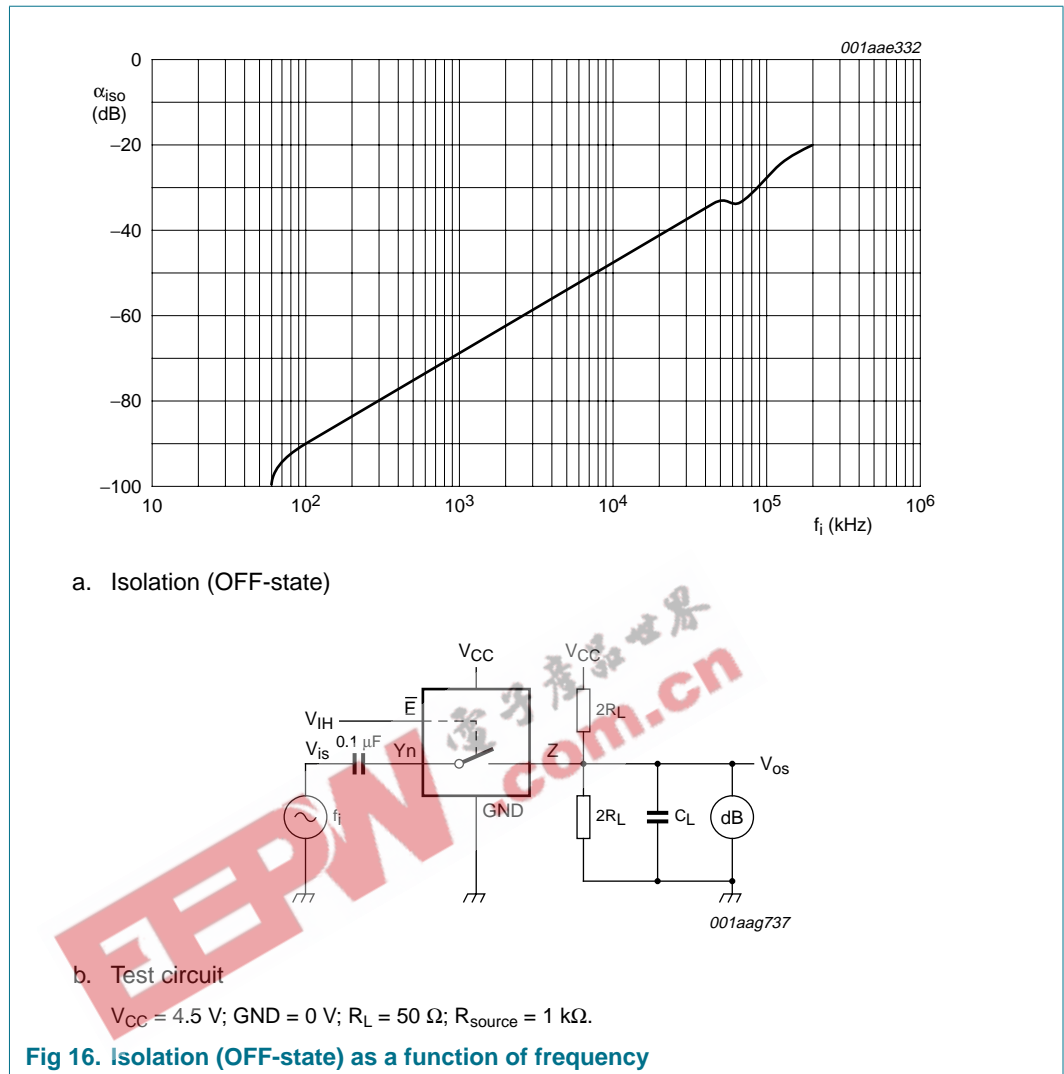

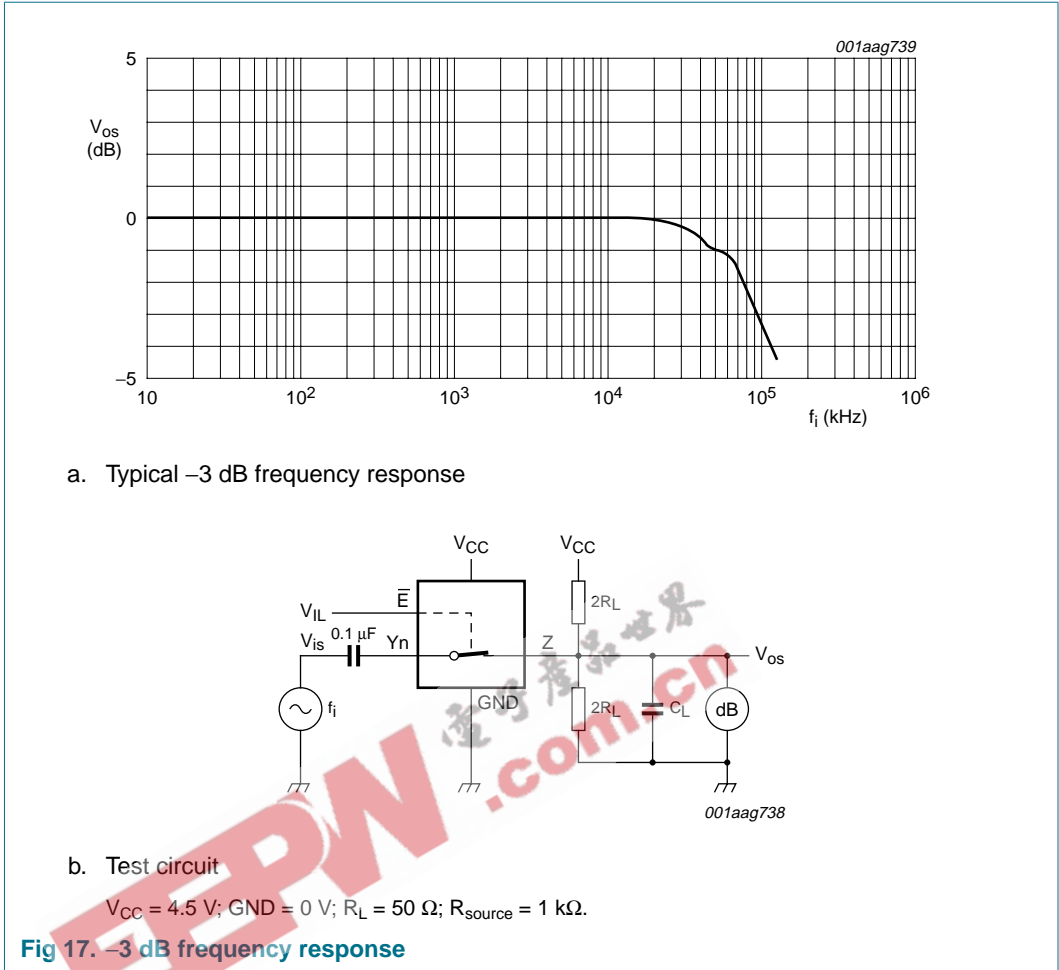

14. Package outline

DIP24: plastic dual in-line package; 24 leads (600 mil)

SOT101-1

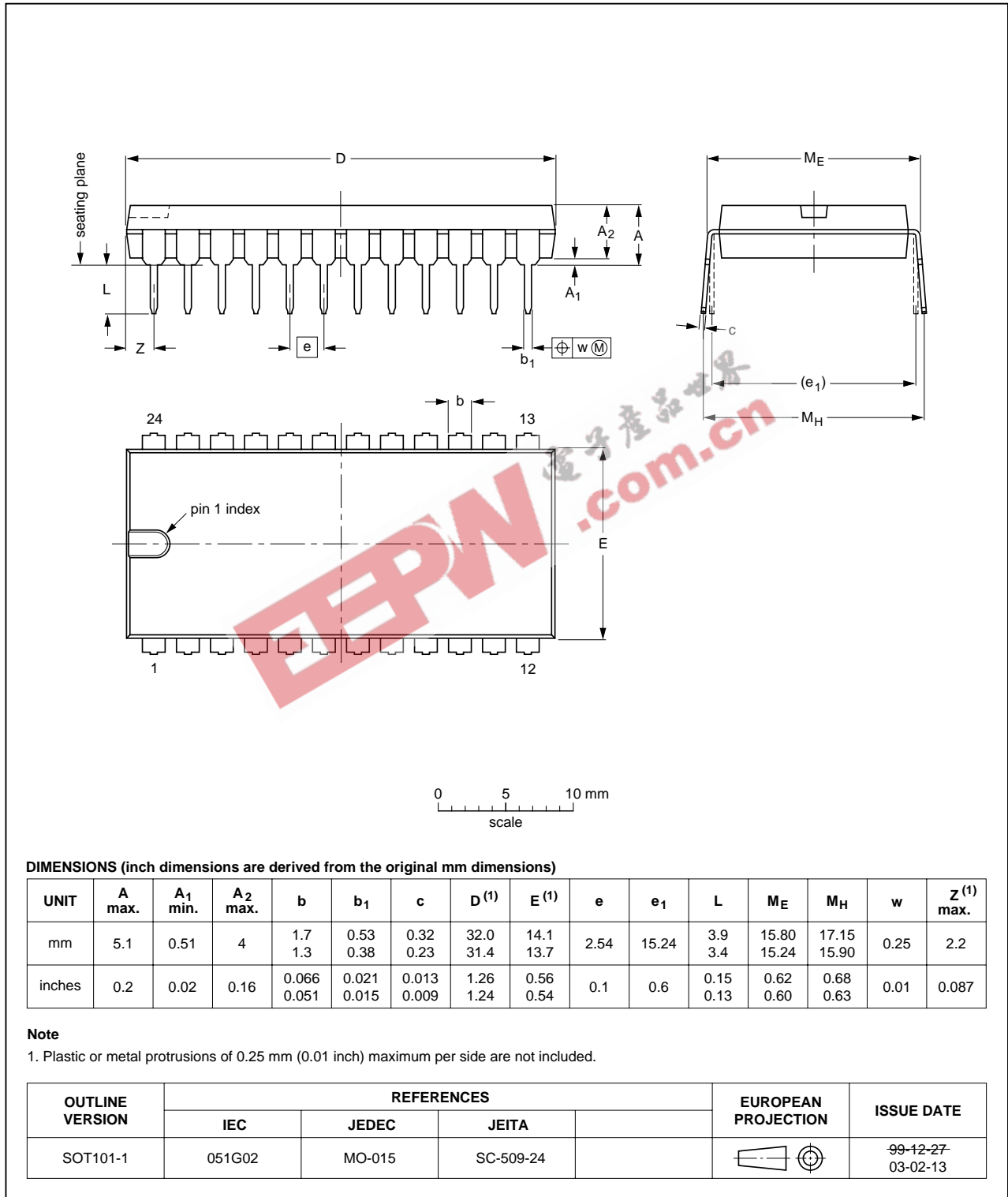

Fig 18. Package outline SOT101-1 (DIP24)

SO24: plastic small outline package; 24 leads; body width 7.5 mm

SOT137-1

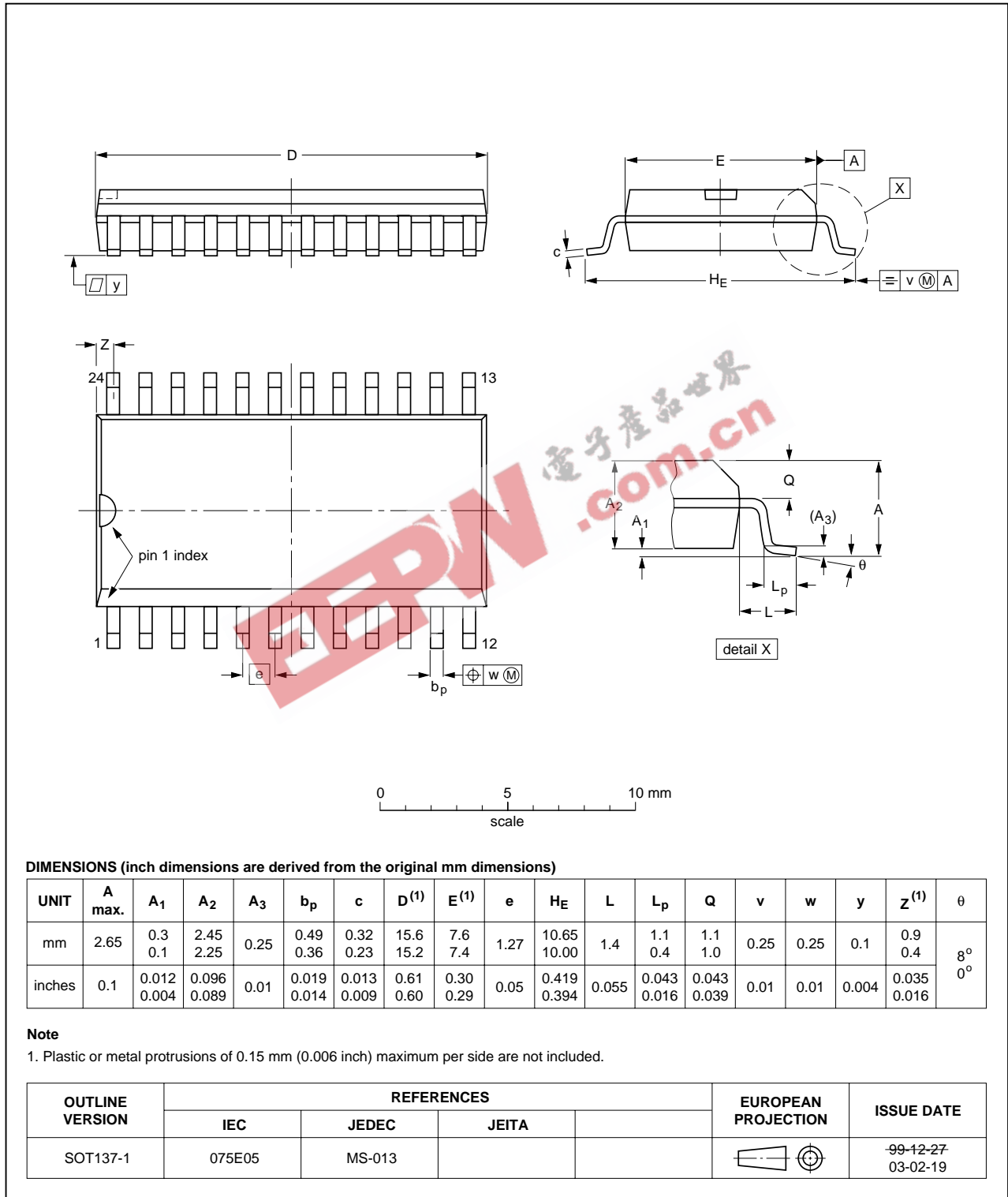

Fig 19. Package outline SOT137-1 (SO24)

SSOP24: plastic shrink small outline package; 24 leads; body width 5.3 mm

SOT340-1

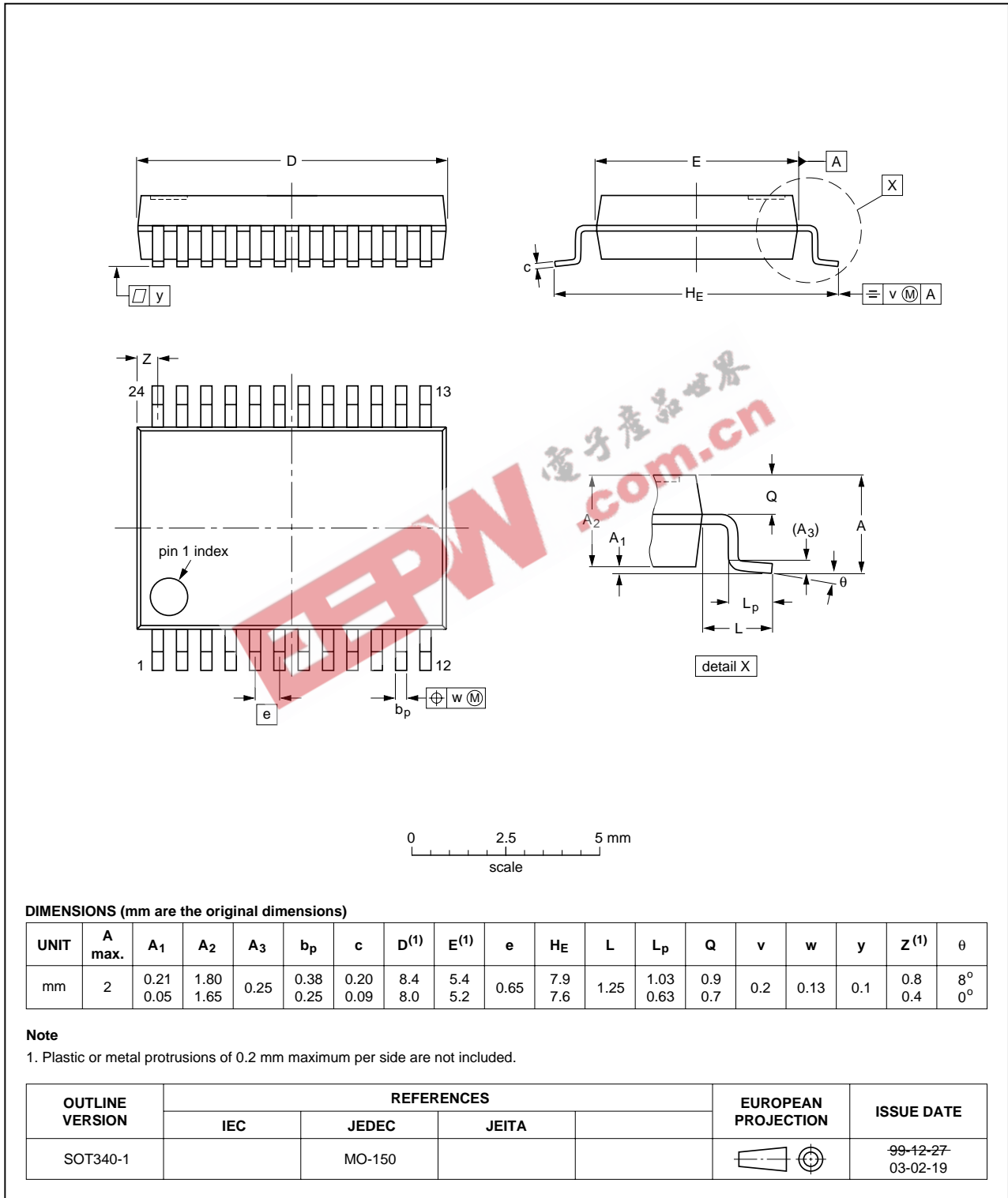

Fig 20. Package outline SOT340-1 (SSOP24)



TSSOP24: plastic thin shrink small outline package; 24 leads; body width 4.4 mm

SOT355-1

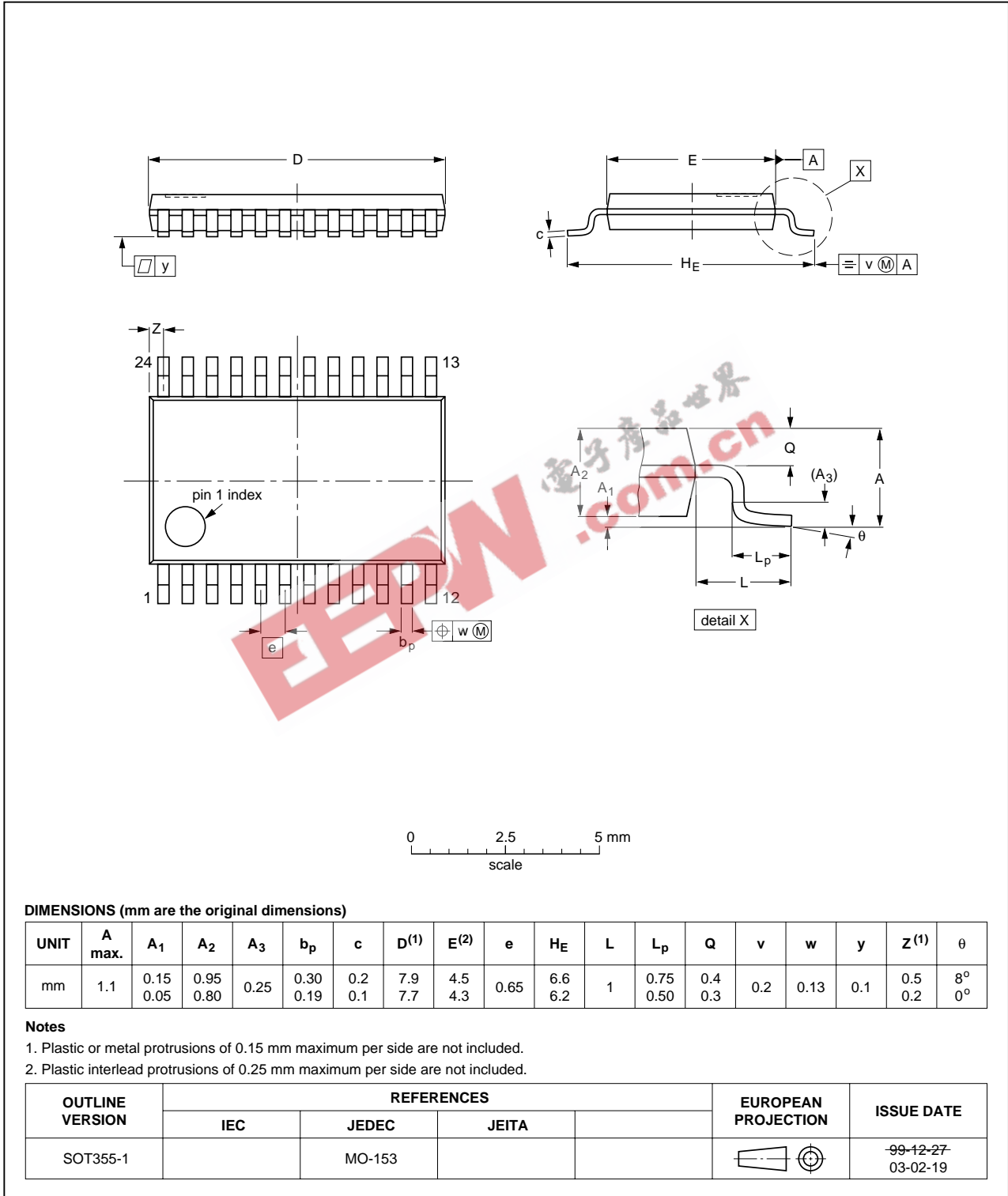

Fig 21. Package outline SOT355-1 (TSSOP24)

DHVQFN24: plastic dual in-line compatible thermal enhanced very thin quad flat package; no leads; 24 terminals; body 3.5 x 5.5 x 0.85 mm

SOT815-1

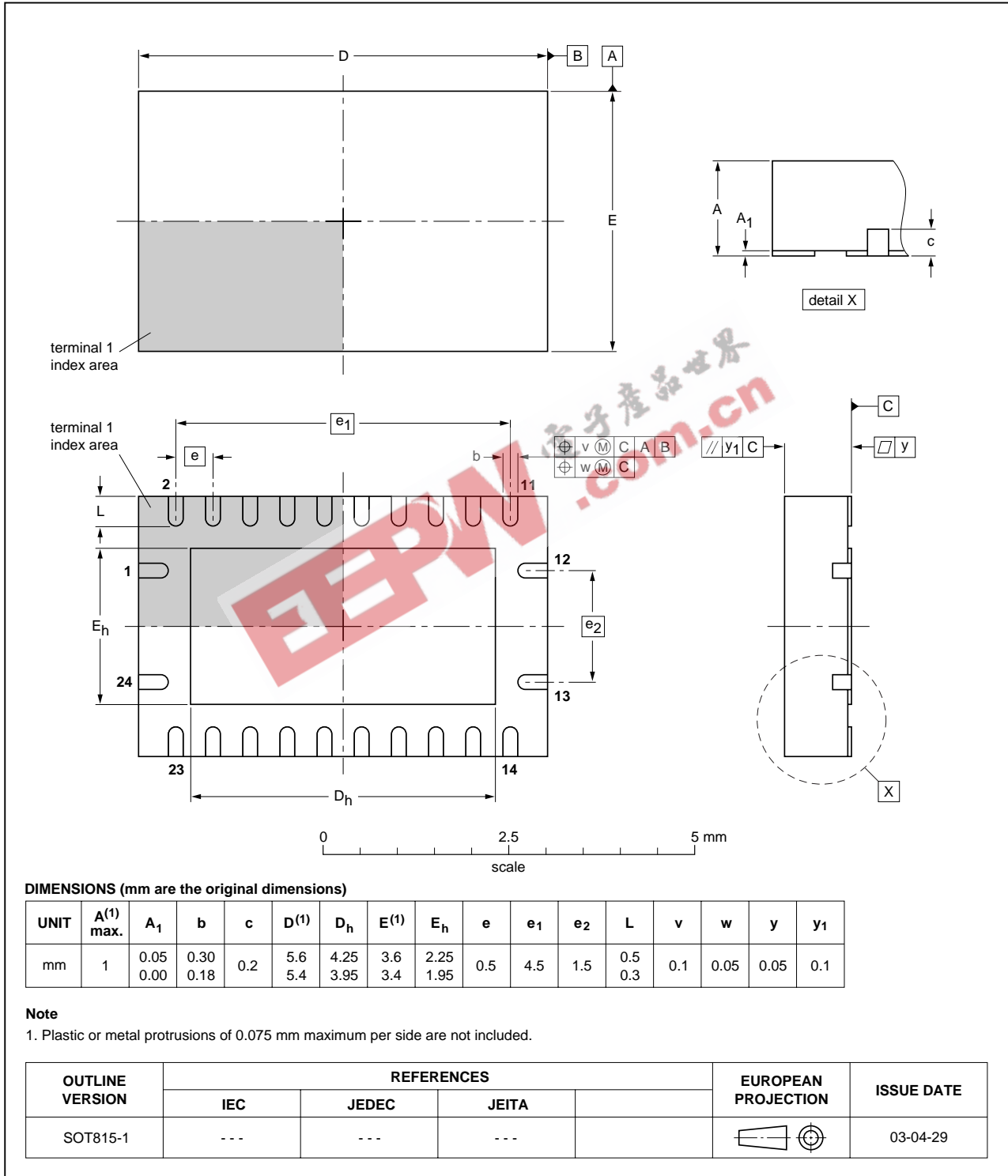

Fig 22. Package outline SOT815-1 (DHVQFN24)

## 15. Revision history

**Table 14. Revision history**

Document ID	Release date	Data sheet status	Change notice	Supersedes
74HC_HCT4067_3	20071015	Product data sheet	-	74HC_HCT4067_CNV_2
Modifications:				
				<ul style="list-style-type: none"><li>• The format of this data sheet has been redesigned to comply with the new identity guidelines of NXP Semiconductors.</li><li>• Legal texts have been adapted to the new company name where appropriate.</li><li>• Added: type numbers 74HC4067BQ and 74HCT4067BQ (DHVQFN24 package).</li></ul>
74HC_HCT4067_CNV_2	19970901	Product specification	-	-

EEPW 电子產品世界  
.com.cn

## 16. Legal information

### 16.1 Data sheet status

Document status <sup>[1][2]</sup>	Product status <sup>[3]</sup>	Definition
Objective [short] data sheet	Development	This document contains data from the objective specification for product development.
Preliminary [short] data sheet	Qualification	This document contains data from the preliminary specification.
Product [short] data sheet	Production	This document contains the product specification.

[1] Please consult the most recently issued document before initiating or completing a design.

[2] The term 'short data sheet' is explained in section "Definitions".

[3] The product status of device(s) described in this document may have changed since this document was published and may differ in case of multiple devices. The latest product status information is available on the Internet at URL <http://www.nxp.com>.

### 16.2 Definitions

**Draft** — The document is a draft version only. The content is still under internal review and subject to formal approval, which may result in modifications or additions. NXP Semiconductors does not give any representations or warranties as to the accuracy or completeness of information included herein and shall have no liability for the consequences of use of such information.

**Short data sheet** — A short data sheet is an extract from a full data sheet with the same product type number(s) and title. A short data sheet is intended for quick reference only and should not be relied upon to contain detailed and full information. For detailed and full information see the relevant full data sheet, which is available on request via the local NXP Semiconductors sales office. In case of any inconsistency or conflict with the short data sheet, the full data sheet shall prevail.

### 16.3 Disclaimers

**General** — Information in this document is believed to be accurate and reliable. However, NXP Semiconductors does not give any representations or warranties, expressed or implied, as to the accuracy or completeness of such information and shall have no liability for the consequences of use of such information.

**Right to make changes** — NXP Semiconductors reserves the right to make changes to information published in this document, including without limitation specifications and product descriptions, at any time and without notice. This document supersedes and replaces all information supplied prior to the publication hereof.

**Suitability for use** — NXP Semiconductors products are not designed, authorized or warranted to be suitable for use in medical, military, aircraft, space or life support equipment, nor in applications where failure or

malfunction of a NXP Semiconductors product can reasonably be expected to result in personal injury, death or severe property or environmental damage. NXP Semiconductors accepts no liability for inclusion and/or use of NXP Semiconductors products in such equipment or applications and therefore such inclusion and/or use is at the customer's own risk.

**Applications** — Applications that are described herein for any of these products are for illustrative purposes only. NXP Semiconductors makes no representation or warranty that such applications will be suitable for the specified use without further testing or modification.

**Limiting values** — Stress above one or more limiting values (as defined in the Absolute Maximum Ratings System of IEC 60134) may cause permanent damage to the device. Limiting values are stress ratings only and operation of the device at these or any other conditions above those given in the Characteristics sections of this document is not implied. Exposure to limiting values for extended periods may affect device reliability.

**Terms and conditions of sale** — NXP Semiconductors products are sold subject to the general terms and conditions of commercial sale, as published at <http://www.nxp.com/profile/terms>, including those pertaining to warranty, intellectual property rights infringement and limitation of liability, unless explicitly otherwise agreed to in writing by NXP Semiconductors. In case of any inconsistency or conflict between information in this document and such terms and conditions, the latter will prevail.

**No offer to sell or license** — Nothing in this document may be interpreted or construed as an offer to sell products that is open for acceptance or the grant, conveyance or implication of any license under any copyrights, patents or other industrial or intellectual property rights.

### 16.4 Trademarks

Notice: All referenced brands, product names, service names and trademarks are the property of their respective owners.

## 17. Contact information

For additional information, please visit: <http://www.nxp.com>

For sales office addresses, send an email to: [salesaddresses@nxp.com](mailto:salesaddresses@nxp.com)

18. Contents

1 General description ..... 1

2 Features ..... 1

3 Applications ..... 1

4 Ordering information ..... 2

5 Functional diagram ..... 3

6 Pinning information ..... 6

6.1 Pinning ..... 6

6.2 Pin description ..... 6

7 Functional description ..... 7

8 Limiting values ..... 8

9 Recommended operating conditions ..... 8

10 Static characteristics ..... 9

11 Dynamic characteristics ..... 14

12 Waveforms ..... 17

13 Additional dynamic characteristics ..... 19

14 Package outline ..... 22

15 Revision history ..... 27

16 Legal information ..... 28

16.1 Data sheet status ..... 28

16.2 Definitions ..... 28

16.3 Disclaimers ..... 28

16.4 Trademarks ..... 28

17 Contact information ..... 28

18 Contents ..... 29



Please be aware that important notices concerning this document and the product(s) described herein, have been included in section 'Legal information'.

© NXP B.V. 2007.

All rights reserved.

For more information, please visit: <http://www.nxp.com>

For sales office addresses, please send an email to: [salesaddresses@nxp.com](mailto:salesaddresses@nxp.com)

Date of release: 15 October 2007

Document identifier: 74HC\_HCT4067\_3