

## 74LVX245

### Low Voltage Octal Bidirectional Transceiver

#### General Description

The LVX245 contains eight non-inverting bidirectional buffers and is intended for bus-oriented applications. The Transmit/Receive (T/R) input determines the direction of data flow through the bidirectional transceiver. Transmit (active-HIGH) enables data from A ports to B ports; Receive (active-LOW) enables data from B ports to A ports. The Output Enable input, when HIGH, disables both A and B ports by placing them in a high impedance condition.

#### Features

- Ideal for low power/low noise 3.3V applications
- Guaranteed simultaneous switching noise level and dynamic threshold performance

#### Ordering Code

Order Number	Package Number	Package Description
74LVX245M	M20B	20-Lead Small Outline Integrated Circuit (SOIC), JEDEC MS-013, 0.300" Wide
74LVX245SJ	M20D	Pb-Free 20-Lead Small Outline Package (SOP), EIAJ TYPE II, 5.3mm Wide
74LVX245MTC	MTC20	20-Lead Thin Shrink Small Outline Package (TSSOP), JEDEC MO-153, 4.4mm Wide

Devices also available in Tape and Reel. Specify by appending the suffix letter "X" to the ordering code.  
Pb-Free package per JEDEC J-STD-020B.

#### Logic Symbols

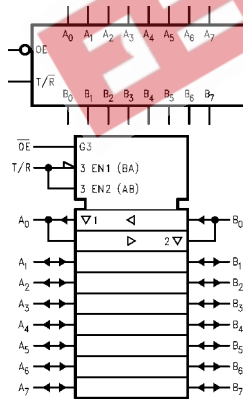

#### Connection Diagram

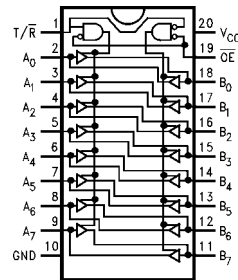

#### Pin Descriptions

Pin Names	Description
OE	Output Enable Input
T/R	Transmit/Receive Input
A <sub>0</sub> -A <sub>7</sub>	Side A Inputs or 3-STATE Outputs
B <sub>0</sub> -B <sub>7</sub>	Side B Inputs or 3-STATE Outputs

#### Truth Table

Inputs		Outputs
OE	T/R	
L	L	Bus B Data to Bus A
L	H	Bus A Data to Bus B
H	X	HIGH-Z State

H = HIGH Voltage Level  
L = LOW Voltage Level

X = Immaterial

**Absolute Maximum Ratings** (Note 1)

Supply Voltage ( $V_{CC}$ )	-0.5V to +7.0V
DC Input Diode Current ( $I_{IK}$ )	
$V_I = -0.5V$	-20 mA
DC Input Voltage $T/\bar{R}, \overline{OE}$ ( $V_I$ )	-0.5V to 7V
DC Diode Current ( $I_{OK}$ )	
$V_O = -0.5V$	-20 mA
$V_O = V_{CC} + 0.5V$	+20 mA
DC Bus I/O Voltage ( $V_{I/O}$ )	-0.5V to $V_{CC} + 0.5V$
DC Output Source or Sink Current ( $I_O$ )	$\pm 25$ mA
DC $V_{CC}$ or Ground Current ( $I_{CC}$ or $I_{GND}$ )	$\pm 75$ mA
Storage Temperature ( $T_{STG}$ )	-65°C to +150°C
Power Dissipation	180 mW

**Recommended Operating Conditions** (Note 2)

Supply Voltage ( $V_{CC}$ )	2.0V to 3.6V
Input Voltage $T/\bar{R}, \overline{OE}$ ( $V_I$ )	0V to 5.5V
Bus I/O Voltage ( $V_{I/O}$ )	0V to $V_{CC}$
Operating Temperature ( $T_A$ )	-40°C to +85°C
Input Rise and Fall Time ( $\Delta t/\Delta V$ )	0 ns/V to 100 ns/V

**Note 1:** The "Absolute Maximum Ratings" are those values beyond which the safety of the device cannot be guaranteed. The device should not be operated at these limits. The parametric values defined in the Electrical Characteristics tables are not guaranteed at the absolute maximum ratings. The "Recommended Operating Conditions" table will define the conditions for actual device operation.

**Note 2:** Unused inputs must be held HIGH or LOW. They may not float.

**DC Electrical Characteristics**

Symbol	Parameter	$V_{CC}$	$T_A = +25^\circ\text{C}$			$T_A = -40^\circ\text{C to } +85^\circ\text{C}$		Units	Conditions
			Min	Typ	Max	Min	Max		
$V_{IH}$	HIGH Level	2.0	1.5			1.5	V		
	Input	3.0	2.0			2.0			
	Voltage	3.6	2.4			2.4			
$V_{IL}$	LOW Level	2.0			0.5		V		
	Input	3.0			0.8				
	Voltage	3.6			0.8				
$V_{OH}$	HIGH Level	2.0	1.9	2.0		1.9	V	$V_{IN} = V_{IH}$ or $V_{IL}$ $I_{OH} = -50 \mu\text{A}$ $I_{OH} = -50 \mu\text{A}$ $I_{OH} = -4 \text{ mA}$	
	Output	3.0	2.9	3.0		2.9			
	Voltage	3.0	2.58			2.48			
$V_{OL}$	LOW Level	2.0		0.0	0.1		V	$V_{IN} = V_{IH}$ or $V_{IL}$ $I_{OL} = 50 \mu\text{A}$ $I_{OL} = 50 \mu\text{A}$ $I_{OL} = 4 \text{ mA}$	
	Output	3.0		0.0	0.1				
	Voltage	3.0			0.36				
$I_{OZ}$	3-STATE Output Off-State Current	3.6			$\pm 0.25$		$\mu\text{A}$	$V_{IN} = V_{IH}$ or $V_{IL}$ $V_{OUT} = V_{CC}$ or GND	
$I_{IN}$	Input Leakage Current	3.6			$\pm 0.1$		$\mu\text{A}$	$V_{IN} = 5.5V$ or GND	
$I_{CC}$	Quiescent Supply Current	3.6			4.0		$\mu\text{A}$	$V_{IN} = V_{CC}$ or GND	

**Noise Characteristics** (Note 3)

Symbol	Parameter	$V_{CC}$ (V)	$T_A = 25^\circ\text{C}$		Units	Conditions $C_L$ (pF)
			Typ	Limit		
$V_{OLP}$	Quiet Output Maximum Dynamic $V_{OL}$	3.3	0.5	0.8	V	50
$V_{OLV}$	Quiet Output Minimum Dynamic $V_{OL}$	3.3	-0.5	-0.8	V	50
$V_{IHD}$	Minimum HIGH Level Dynamic Input Voltage	3.3		2.0	V	50
$V_{ILD}$	Maximum LOW Level Dynamic Input Voltage	3.3		0.8	V	50

**Note 3:** Input  $t_r = t_f = 3$  ns

## AC Electrical Characteristics

Symbol	Parameter	V <sub>CC</sub> (V)	T <sub>A</sub> = +25°C			T <sub>A</sub> = -40°C to +85°C		Units	Conditions
			Min	Typ	Max	Min	Max		
t <sub>PLH</sub>	Propagation Delay Time	2.7		6.1	10.7	1.0	13.5	ns	C <sub>L</sub> = 15 pF
t <sub>PHL</sub>				8.6	14.2	1.0	17.0		C <sub>L</sub> = 50 pF
		3.3 ± 0.3		4.7	6.8	1.0	8.0		C <sub>L</sub> = 15 pF
				7.2	10.1	1.0	11.5		C <sub>L</sub> = 50 pF
t <sub>PZL</sub>	3-STATE Output Enable Time	2.7		9.0	16.9	1.0	20.5	ns	C <sub>L</sub> = 15 pF, R <sub>L</sub> = 1 kΩ
t <sub>PZH</sub>				11.5	20.4	1.0	24.0		C <sub>L</sub> = 50 pF, R <sub>L</sub> = 1 kΩ
		3.3 ± 0.3		7.1	11.0	1.0	13.0		C <sub>L</sub> = 15 pF, R <sub>L</sub> = 1 kΩ
				9.6	14.5	1.0	16.5		C <sub>L</sub> = 50 pF, R <sub>L</sub> = 1 kΩ
t <sub>PLZ</sub>	3-STATE Output Disable Time	2.7		11.5	18.0	1.0	21.0	ns	C <sub>L</sub> = 50 pF, R <sub>L</sub> = 1 kΩ
t <sub>PHZ</sub>		3.3 ± 0.3		9.6	12.8	1.0	14.5		C <sub>L</sub> = 50 pF, R <sub>L</sub> = 1 kΩ
t <sub>OSLH</sub>	Output to Output Skew (Note 4)	2.7			1.5		1.5	ns	C <sub>L</sub> = 50 pF (Note 4)
t <sub>OSHL</sub>		3.3					1.5		

Note 4: Parameter guaranteed by design. t<sub>OSLH</sub> = |t<sub>PLHm</sub> - t<sub>PLHn</sub>|, t<sub>OSHL</sub> = |t<sub>PHLm</sub> - t<sub>PHLn</sub>|

## Capacitance

Symbol	Parameter	T <sub>A</sub> = +25°C			T <sub>A</sub> = -40°C to +85°C		Units
		Min	Typ	Max	Min	Max	
C <sub>IN</sub>	Input Capacitance T/R, OE		4	10		10	pF
C <sub>I/O</sub>	Output Capacitance A <sub>n</sub> , B <sub>n</sub>		8				pF
C <sub>PD</sub>	Power Dissipation Capacitance (Note 5)		21				pF

Note 5: C<sub>PD</sub> is defined as the value of the internal equivalent capacitance which is calculated from the operating current consumption without load.

$$\text{Average operating current can be obtained by the equation: } I_{CC(\text{opr.})} = \frac{C_{PD} \times V_{CC} \times f_{IN} + I_{CC}}{8 \text{ (per bit)}}$$

**Physical Dimensions** inches (millimeters) unless otherwise noted

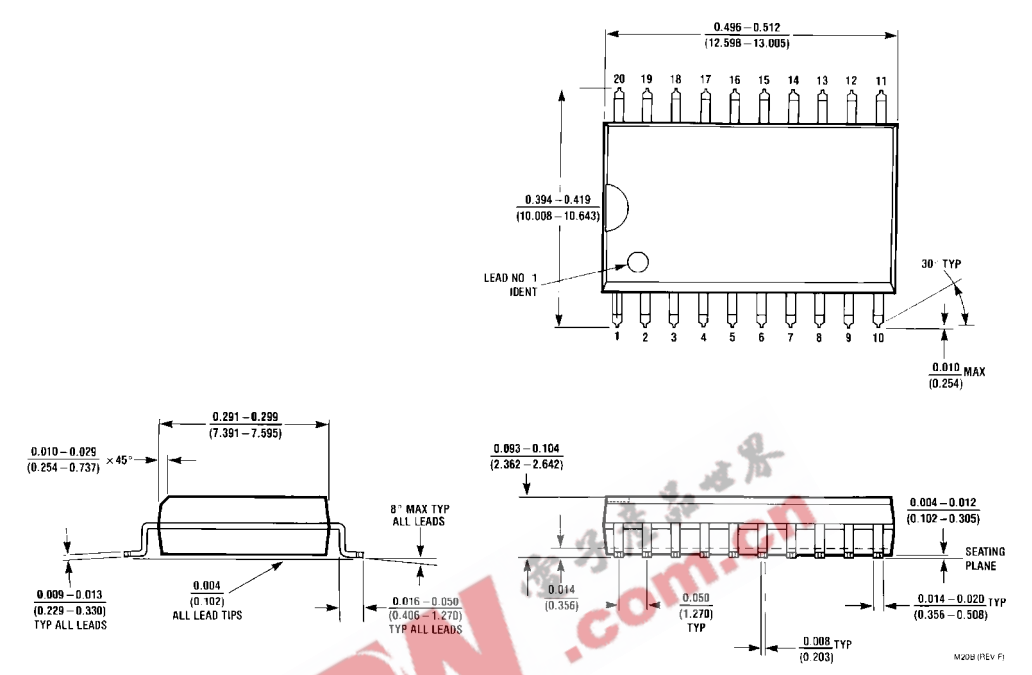

**20-Lead Small Outline Integrated Circuit (SOIC), JEDEC MS-013, 0.300" Wide  
Package Number M20B**

**Physical Dimensions** inches (millimeters) unless otherwise noted (Continued)

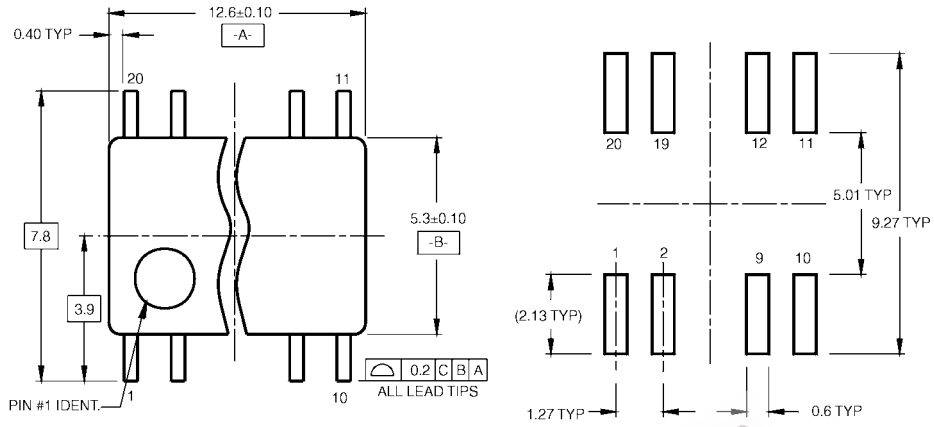

LAND PATTERN RECOMMENDATION

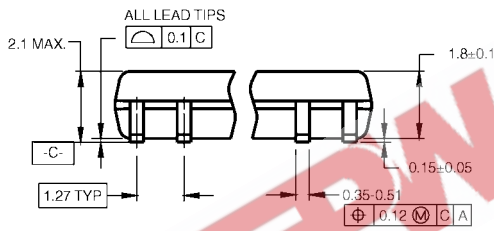

DIMENSIONS ARE IN MILLIMETERS

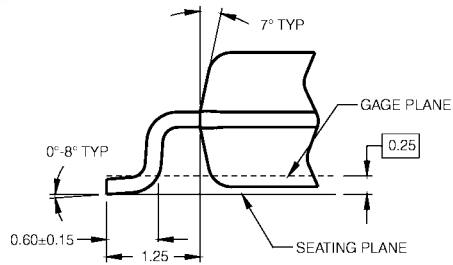
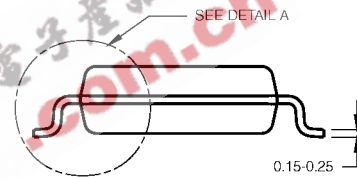

DETAIL A

NOTES:

- A. CONFORMS TO EIAJ EDR-7320 REGISTRATION, ESTABLISHED IN DECEMBER, 1998.
- B. DIMENSIONS ARE IN MILLIMETERS.
- C. DIMENSIONS ARE EXCLUSIVE OF BURRS, MOLD FLASH, AND TIE BAR EXTRUSIONS.

M20DRevB1

**Pb-Free 20-Lead Small Outline Package (SOP), EIAJ TYPE II, 5.3mm Wide  
Package Number M20D**

**Physical Dimensions** inches (millimeters) unless otherwise noted (Continued)

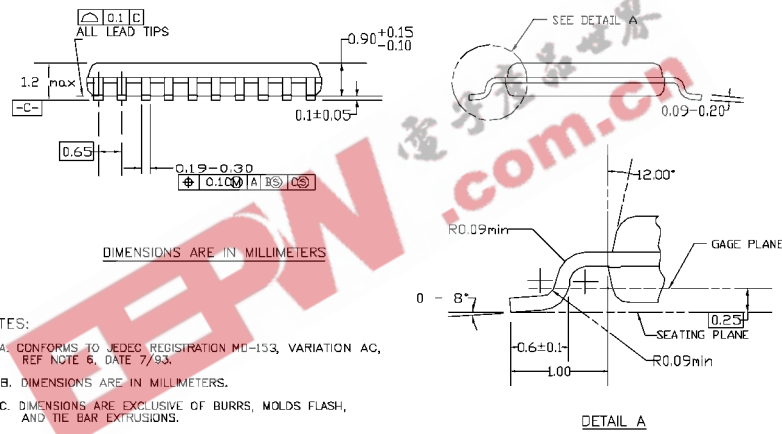
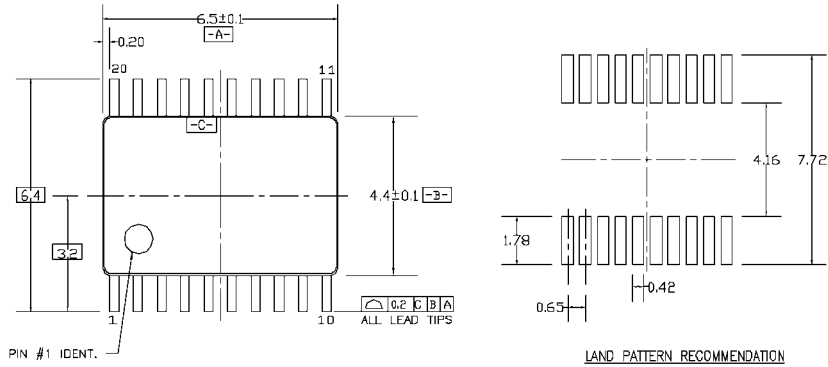

- NOTES:
- A. CONFORMS TO JEDEC REGISTRATION MO-153, VARIATION AC, REF NOTE 6, DATE 7/93.
  - B. DIMENSIONS ARE IN MILLIMETERS.
  - C. DIMENSIONS ARE EXCLUSIVE OF BURRS, MOLDS FLASH, AND TIE BAR EXTRUSIONS.
  - D. DIMENSIONS AND TOLERANCES PER ANSI Y14.5M, 1982.

MTC20REV D1

**20-Lead Thin Shrink Small Outline Package (TSSOP), JEDEC MO-153, 4.4mm Wide Package Number MTC20**

Fairchild does not assume any responsibility for use of any circuitry described, no circuit patent licenses are implied and Fairchild reserves the right at any time without notice to change said circuitry and specifications.

**LIFE SUPPORT POLICY**

FAIRCHILD'S PRODUCTS ARE NOT AUTHORIZED FOR USE AS CRITICAL COMPONENTS IN LIFE SUPPORT DEVICES OR SYSTEMS WITHOUT THE EXPRESS WRITTEN APPROVAL OF THE PRESIDENT OF FAIRCHILD SEMICONDUCTOR CORPORATION. As used herein:

1. Life support devices or systems are devices or systems which, (a) are intended for surgical implant into the body, or (b) support or sustain life, and (c) whose failure to perform when properly used in accordance with instructions for use provided in the labeling, can be reasonably expected to result in a significant injury to the user.
2. A critical component in any component of a life support device or system whose failure to perform can be reasonably expected to cause the failure of the life support device or system, or to affect its safety or effectiveness.

[www.fairchildsemi.com](http://www.fairchildsemi.com)